

Circuit breakers / Manual motor starters, Type CTI 15

Introduction

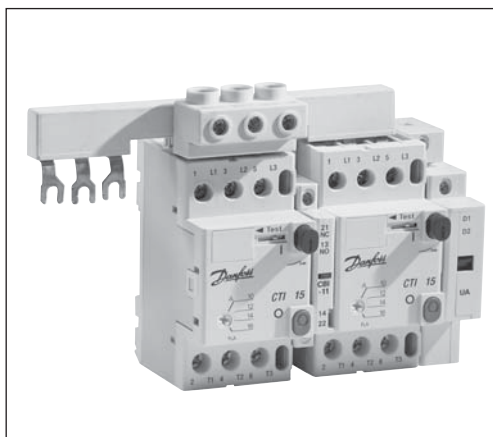

Circuit breakers/Manual motor starters CTI 15 cover the power ranges 0.09-7.5 kW. This product range is modular, flexible, and offers a large selection of clip-on auxiliary functions and accessories: auxiliary contact blocks, shunt releases, connection terminal, bus bars and enclosures.

Features

- Short-circuit protection: An advanced and fast reacting contact system with arc-control devices give CTI high short-circuit break capability which makes them very suitable for the protection of electrical panels.
- Indicating functions:
 - condition (ON or OFF)
- Supply isolation:
 - operation switch (manual motor starter)
 - isolation switch (with locking device)
 - emergency stop switch (with undervoltage trip)

Ordering





CTI15

Circuit breakers/Manual motor starters CTI 15

AC-3 load U_e 380-415 V kW	Range Motor starter A	Electromagnetic trip current A	Code no.	Type
0.09	0.25 - 0.4	4.4	047B3051	CTI 15
0.12	0.4 - 0.63	6.9	047B3052	
0.37	0.63 - 1.0	11	047B3053	
0.55	1.0 - 1.6	18	047B3054	
0.75	1.6 - 2.5	28	047B3055	
1.5	2.5 - 4.0	44	047B3056	
2.5	4.0 - 6.3	69	047B3057	
5.5	6.3 - 10	110	047B3058	
7.5	10 - 16	176	047B3059	

Accessories for circuit breakers/manual motor starters CTI 15

Description	Comments	Code no.
 CBI - NO - NC Auxiliary contact block	Auxiliary contact blocks for building in	047B3040
	CBI-NO (make) terminal 13-14	047B3041
	CBI-NO (make) terminal 23-24	047B3042
	CBI-NC (break) terminal 11-12	
	Auxiliary contact blocks for lefthand mounting	047B3049
CBI - 11 Auxiliary contact block	Undervoltage trip for righthand mounting	047B3061
	CBI-UA 220-230 V, 50 Hz - 254 V, 60 Hz, D1-D2	047B3062
CBI - UA/ CBI - AA Undervoltage trip/ Shunt trip	CBI-UA 240 V, 50 Hz - 277 V, 60 Hz, D1-D2	
	Shunt trip for righthand mounting	047B3067
	CBI-AA 220-230 V, 50 Hz - 254 V, 60 Hz, C1-C2	047B3068
	CBI-AA 240 V, 50 Hz - 277 V, 60 Hz, C1-C2	
Terminal block for CTI 15	For mounting direct on CTI 15, max. 16 mm ² , CTT 25	047B3076
Lockable bracket for CTI 15	For locking CTI 15 mounted in panel (up to three padlocks) Type CBI LB	047B3093
 CBI - UA/ CBI - AA Undervoltage trip/ Shunt trip	For parallel connection fo CTI 15 in panel	047B3084
	CTS 45-2 (2 x 45 mm)	047B3096
	CTS 45-3 (2 x 45 mm)	047B3085
	CTS 45-4 (2 x 45 mm)	047B3086
	CTS 45-5 (2 x 45 mm)	
	For CTI 15 with auxiliary contact mounted on side	047B3087
	CTS 54-2 (2 x 54 mm)	047B3097
	CTS 54-3 (3 x 54 mm)	047B3088
	CTS 54-4 (4 x 54 mm)	047B3089
CTS 54-5 (5 x 54 mm)		
Terminal cover	Finger protection of terminals on CTS	047B3101
Connection module for CTI 15	For connection between CTI 15 and CI 6-15 connectors CTC 15-15	047B3002

Plastic enclosures for circuit breakers/manual motor starters CTI 15 (IP 55)

Application	Pushbuttons	Knockouts	Code no.	Type ^{1) 2)}
CTI 15	Start-Stop/reset	4 Pg 16/4 Pg 21	047B3091	BXI 55

¹⁾ With neutral and earth terminals

²⁾ The enclosure also leaves space for a shunt release or an undervoltage release.

Enclosure BXI
For CTI 15



Accessories for enclosures and circuit breakers

Description	Comments	Code no.
Lock fittings for boxes BXI	for use in servicing and inspection on BXI enclosures, type CBI LA	047B3092
Diaphragm for BXI 55	For replacement in BXI enclosure	047B3099

CTT 25
Terminal block



Terminal cover for CTS



CTS 54-
Bus bar



CTC 15-15
Connection module

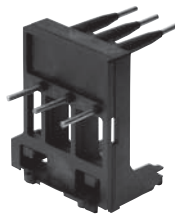

Contact symbols and terminal markings

Circuit breakers

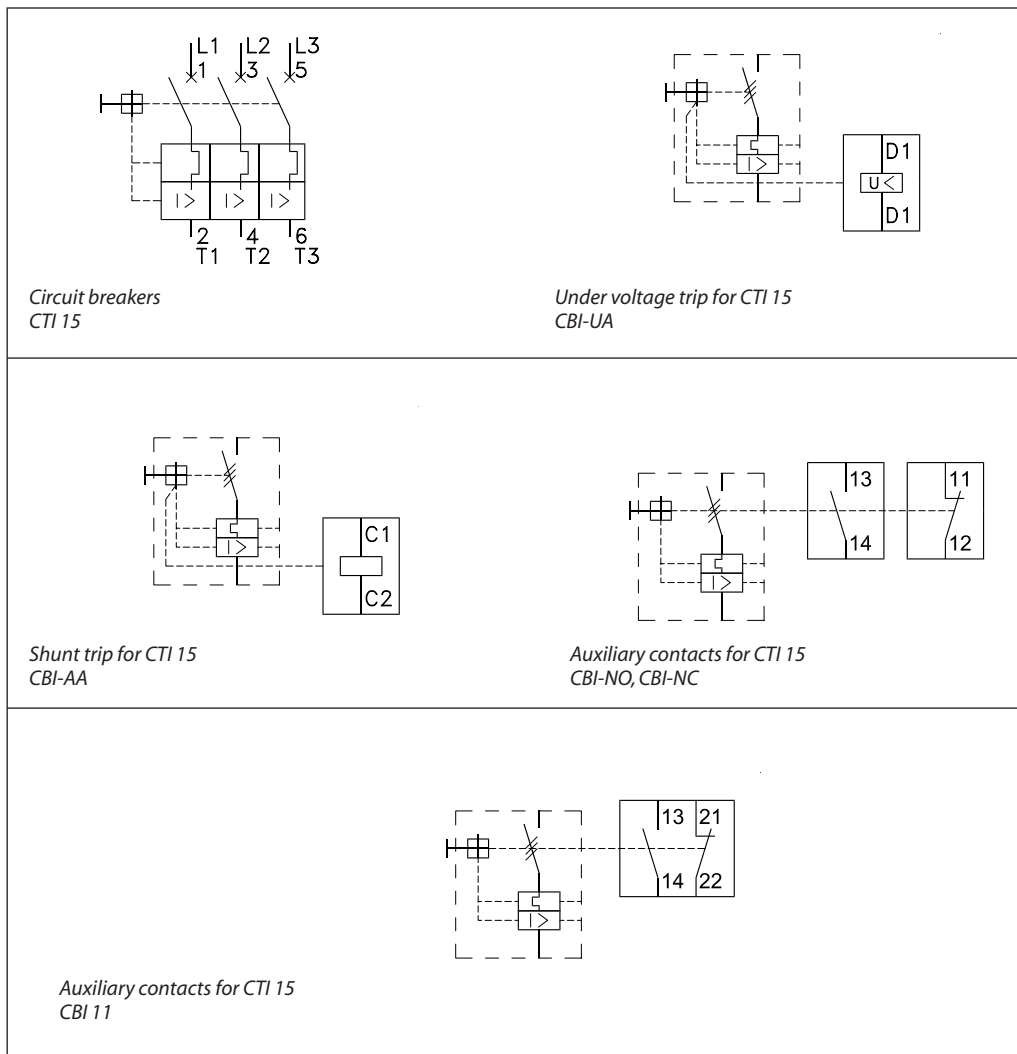

Approvals

Product type	Approval authority		
	CE EN 60947	CSA Canada	UL UL-listed USA
CTI 15	●	●	●
CTS-	●	●	●
CTT 25	●	●	●
CBI-	●	●	●
CTC	●	●	●

● Approved

General data

Parameters		Type
		CTI 15
Isolation voltage	IEC, cULus	690 V
Pulse voltage		6 kV
Rated frequency range		40-60 Hz
Ambient temperature	Storage/transport	-25 °C - +80 °C
	Operation	-25 °C - +60 °C
Temperature compensated		-20 °C - +60 °C
Weather resistance	(IEC 68) Temp./rel. humidity Temperate climate	40 °C, 92% RH: 56 days
		23 °C, 83% RH/40 °C, 93% RH
Vibration (IEC 68) (all directions)		> 7,5 g, 10 - 150 Hz
Shock (IEC 68-2-27)		30 g, 20 ms
Degree of protection		IP 20
Installation orientation		Any direction
Rated current		0.25 - 16 A
Release range		9
Differential release		no
Magnetic trip (I _{eF} max. = setting range max. value)		11 x I _{eFmax}
No. of operations per hour		30
Mechanical life (operations)		100.000
Electrical life (operations)		50.000
Release time on short-circuiting		2 ms
Power loss, typical		7 W

Mounting direction

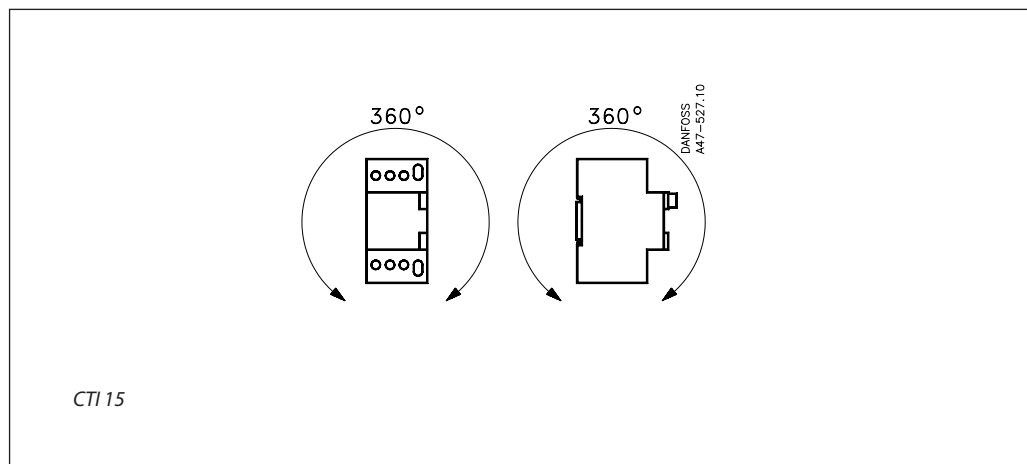

Max. motor load
AC-2 and AC-3 operation

The table contains kW values of rated motor sizes according to IEC 60072 which fits to the current range of the circuit breaker. Sometimes more than one rated current fits to the range. In such cases both values are given and they are valid for AC-2 as well as for AC-3.

Type	Setting range	Motor on operating voltage - Rated output in kW							
		230-240 V		400-415 V		500 V		690 V	
	[A]	[kW]		[kW]		[kW]		[kW]	
CTI 15	0.25 - 0.4	-		0.09	0.12	-		-	
	0.4 - 0.63	0.06	0.09	0.12	0.18	0.18	0.25	0.25	0.37
	0.63 - 1.0	0.12	0.18	0.18	0.25	0.25	0.37	0.37	0.55
	1.0 - 1.6	0.18	0.25	0.37	0.55	0.55	0.75	0.75	1.1
	1.6 - 2.5	0.37	0.55	0.75	1.1	1.1		1.5	1.8
	2.5 - 4.0	0.55	0.75	1.1	1.8	1.5	2.2	2.2	3.0
	4.0 - 6.3	1.1	1.5	1.8	3.0	3.0	3.7	3.7	4.0
	6.3 - 10	1.8	2.2	3.0	4.0	3.7	6.3	5.5	7.5
10 - 16	3.0	4.0	5.5	7.5	6.3	10	10	13	

Accessories for circuit breaker CTI 15

Max. load on supply block, current limiter, connection terminal and bus bar.

Application	Type	Description	Thermal current I _{th} A	Voltage supply V
CTI 15	CTT 25	Connection terminal	63	690
	CTS-	Bus bars	63	

Accessories for circuit breakers

Loads on auxiliary contact blocks

Application	Type	Description	I _{th}		Load [A]							
					AC-15				DC-13			
			40°C	60°C	220 - 240 V	380 - 415 V	500 V	690 V	24 V	48 V	110 V	220 V
CTI 15	CBI-NO/NC	Auxiliary contact for building in	6	4	2	1	0.8	0.5	2	0.6	0.2	0.1
	CBI 11	Auxiliary contact for building on (force-actuated PLC-compatible H contact)	10	6	2	1	0.8	0.5	2	0.6	0.2	0.1

Power consumption, undervoltage and shunt trip

Application	Type	Description	Rated control voltage U _s		Function voltage		Coil consumption	
CTI 15	CBI-UA	Undervoltage trip for building on	24-380 V/50 Hz, 28-440 V/60 Hz		Make	0.8 to 1,1 x U _s		
			Function voltage	Break	0.35 to 0.7 x U _s			
				100% make, max. 1.2 U _s				
	CBI-AA	Shunt trip for building on	Coil consumption		Make	5 VA, 6 W		
				Coil consumption	3 VA, 1.2 W			

Terminations

Application	Type	Comments	Terminals		Single and multi core [mm ²]	High capacity [mm ²]	Tightening torque [Nm]
			1-3-5	2-4-6			
CTI 15	CTI 15	Circuit breaker 16 A	●	●	1 - 6	1 - 4	2.5
	CBI-NO/NC	Auxiliary contacts for CTI 15			0.75 - 4	0.75 - 2.5	2.5
	CBI 11	Auxiliary contacts for CTI 15			0.75 - 4	0.75 - 2.5	2.5
	CBI - AA	Shunt release for CTI 15			0.75 - 4	0.75 - 2.5	2.5
	CBI - UA	Undervoltage release for CTI 15			0.75 - 4	0.75 - 2.5	2.5
	CTT 25	Connection block for CTI 15		●		6 - 25	4 - 16

UL/CSA-approved loads

Type	Setting range [A]	Motor load in hp (AC-3)					
		1-phase operation			3-phase operation		
		115 V	230 V	200 V	230 V	460 V	575 V
CTI 15	0.63 - 1.0					1/2	3/4
	1.0 - 1.6		1/10	1/10		1	1
	1.6 - 2.5	1/10	1/6	1/6	3/4	1.5	2
	2.5 - 4	1/8	1/3	1/3	1	3	3
	4 - 6.3	1/4	3/4	3/4	2	5	5
	6.3 - 10	1/2	1,5	1,5	3	7.5	10
	10 - 16	1	3	3	5	10	15

Terminations UL/CSA

Application	Type	Comments	Terminals		Single and multi core [AWG]	Tightening torque [lb-in]
			1-3-5	2-4-6		
CTI 15	CTI 15	Circuit breaker 16 A	●	●	16 - 12	20 - 26
	CBI-NO/NC	Auxiliary contacts for CTI 15			18 - 14	20 - 26
	CBI 11	Auxiliary contacts for CTI 15			18 - 14	20 - 26
	CBI-AA	Shunt release for CTI 15			18 - 14	20 - 26
	CBI-UA	Undervoltage release for CTI 15			18 - 14	20 - 26
	CTT 25	Connection block for CTI 15		●	14 - 6	36

UL/CSA approved loads

Application	Type	Description	Load	
			a.c.	d.c.
CTI 15	CBI-NO/NC	Auxiliary contact for building in	Standard pilot duty B600	Light pilot dutyR300
	CBI 11	Auxiliary contact for building in		

Short circuit protection

Short circuit coordination is the connection between the specifications of the protection devices, such as fuses, circuit breakers, MCCB and its ability to resist short circuit.

Short circuit coordination type 1

Test demand

O-t-CO

O = Breaking a short circuiting

CO = Making and breaking a short circuiting

t = Defined pause (3 min)

No damage to equipment or personal injury may occur in the event of short circuit. However, contactors and thermal overload relays are not required to remain functional after short circuit.

Typically the maximum short circuit breaking capacity I_{cu} is in use when a plant is dimensioned according to coordination type 1.

Short circuit coordination type 2

Test demand

O-t-CO-t-CO

O = Breaking a short circuiting

CO = Making and breaking a short circuiting

t = Defined pause (3 min)

t= Defined pause (3 min)

No damage to equipment or personal injury may occur in the event of short circuit. However, light contact welding is permissible, provided that contacts can be separated without deformation, using a screwdriver for example. Contactors and thermal overload relays must remain completely functional after short circuit.

Typically the short circuit breaking capacity during operation I_{cs} is in use when a plant is dimensioned according to coordination type 2.

Terms	Remarks
Prospective short circuit current (I_{sc})	The prospective short circuit current is the current that flows during a bolt short circuiting without any short circuit protection device mounted.
Rated service short circuit breaking capacity (I_{cu})	The ultimate short circuit breaking capacity is the maximum short circuit current specified by the manufacturer that a circuit breaker can handle under circumstances specified in IEC 947-2 and in EN 60947-2
Rated service short circuit breaking capacity (I_{cs})	The rated service short circuit breaking capacity is the maximum short circuit current specified by the manufacturer that a circuit breaker can handle under circumstances specified in IEC 947-2 and in EN 60947-2
"r"-current	The "r"-current is a short circuit test current. The size of the "r"-current is determined by the nominal current of the product. (See below)
I_q current	I_q -current is the maximum prospective short circuiting current stated by the manufacturer and often at the value 50 kA.
gL fuse	Indicates full short circuit protection at voltages 250V, 400V, 500V and 690V.
gL fuse	Indicates full short circuit protection of wires.
gG fuse	Indicates full short circuit protection at general applications. (Will replace gL- and gL -fuses)
T fuse	Description of an English standard fuse.
BS 88	British Standard for smeltesikringer

Contactor size	Prospective short circuit test current
Rated current at AC-3 load	"r" in kA
$0 < I_e < 16$	1
$16 < I_e < 63$	3
$63 < I_e < 125$	5
$125 < I_e < 315$	10
$315 < I_e < 630$	18
$630 < I_e < 1000$	30

Fuses

Type	Setting range A	Fuses gI, aM, gL, gG and BS 88 type T when $I_{cc} > I_{cu}$			
		220-240 V	380-415 V	500 V	690 V
CTI 15	0.25 - 0.4				
	0.4 - 0.63				
	0.63 - 1.0				
	1.0 - 1.6				
	1.6 - 2.5				25
	2.5 - 4.0				35
	4.0 - 6.3			63	-
	6.3 - 10.0		63	50	-
	10.0 - 16.0	50	50	50	-

■ = Short-circuit-proof without fuse

Rated short-circuit breaking capacity I_{cn}

Circuit breaker

Type	Thermal overload relay Setting range A	Magnetic trip Release current A	Breaking capacity I_{cn} in kA Short-circuit category I_{cu} and I_{cs} to IEC 947-2/EN 60947-2							
			220 - 240 V		380 - 415 V		500 V		690 V	
			I_{cu}	I_{cs}	I_{cu}	I_{cs}	I_{cu}	I_{cs}	I_{cu}	I_{cs}
CTI 15	0.25-0.4	4.4	65	65	65	65	50	50	50	50
	0.4-0.63	6.9	65	65	65	65	50	50	50	50
	0.63-1.0	11	65	65	65	65	50	50	50	50
	1.0-1.6	18	65	65	65	65	50	50	50	50
	1.6-2.5	28	50	50	50	50	50	50	4.5	4.5
	2.5-4.0	44	50	50	10	10	6	3	2	2
	4.0-6.3	69	50	50	10	10	10	10	-	-
	6.3-10	110	50	50	10	10	4.5	4.5	-	-
	10-16	176	20	16	6	8	4.5	4.5	-	-

Let-through graphs for circuit breaker CTI 15

Maximum let-through energy
Rated voltage 400-415 V

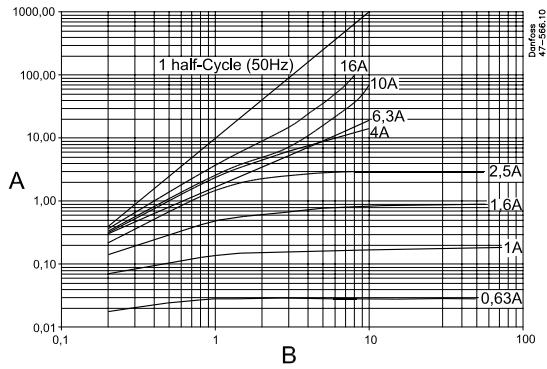

A: Max. let-through energy $\int i^2 \times dt [10^3 \times A^2 \times s]$
B: Prospective short-circuit current I_{cc} [kA]

The energy graph can be used to assess whether a lead is correctly protected against the thermal effect of a short-circuit current.

The graph can be read as follows:

If the expected short-circuit current at the point of installation is set at 8 kA, and a CTI 15 - 10 A is required, the let-through energy will be 40000 A²s.

Calculation example:

The following generally applies to leads subject to brief overload:

$$t = \left(\frac{k \times S}{I} \right)^2 \text{ which gives } I^2 \times t = k^2 \times S^2$$

Where t = duration of short-circuit current in seconds
S = cross-section of lead in mm²
I = short-circuit current in A_{eff}
k = a constant which for PVC-insulated Cu wire = 115

Thus, for a 1.5 mm² PVC-insulated Cu wire, $I^2 \times t = (115 \times 1.5)^2 = 29756 \text{ A}^2\text{s}$.

From the energy graph it can be seen that with $I_{cc} = 8 \text{ kA}$ a CTI 15 with max. range setting = 10 A only allows about 20000 A²s through and therefore protects the lead satisfactorily.

Maximum let-through current
Rated voltage 400-415 V

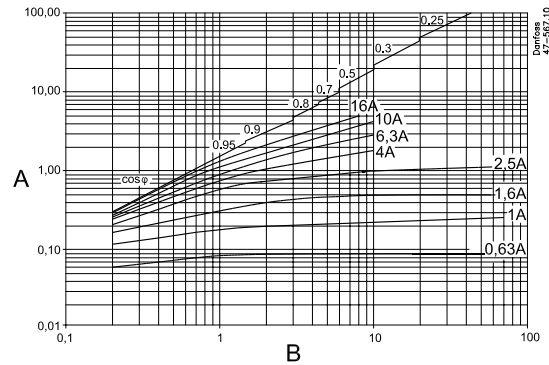

A: Max. let-through current I_D [kA]
B: Prospective short-circuit current I_{cc} [kA]

The theoretical short-circuit current I_{cc} (prospective short-circuit current) is limited by CTI 15. I_d is the maximum let-through current (highest momentary value of the limited short-circuit current). This value is given in the graph as a function of the prospective short-circuit current.

The graphs have been plotted for eight different CTI 15 ranges.

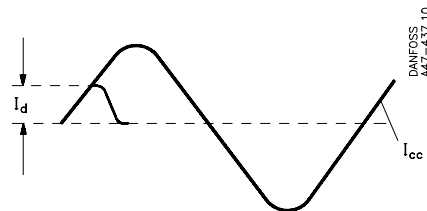

Short-circuit protection of wiring

Type	Max. setting	Protected min. cross-section (mm ²) at 380 / 415 V, 50 Hz					
		6	4	2.5	1.5	1	0.75
CTI 15	4.0	●	●	●	●	●	●
	6.3	●	●	●	●	●	●
	10.0	●	●	●	●	●	
	16.0	●	●	●	●		

Protection of PVC-insulated wires against overload and short-circuiting, in accordance with IEC 364 and CENELEC harmonizing documents 384-3 and 384-4.

Overload protection is given by the adjustable thermal circuit breakers in CTI 15 motor starters. The highest possible release current is therefore significantly lower than with overload protection by fuses. The magnetic trips with fixed setting that rapidly open the main contacts take over protection in the event of short-circuiting. The low total release time ensures that heating generated in leads by short-circuiting is limited to a minimum.

Further information is contained in national regulations.

Setting in short-circuit protection application

In many cases, CTI 15 are used exclusively for short-circuit protection - overload protection being provided by thermal overload relays, e.g. in multi stage motors or star-delta starters with heavy start, and/or in reducing motor lead cross-section. Here, the current value can be set 20% higher than the operating current so that only the thermal overload relays release when overload occurs.

Overload protection of motors

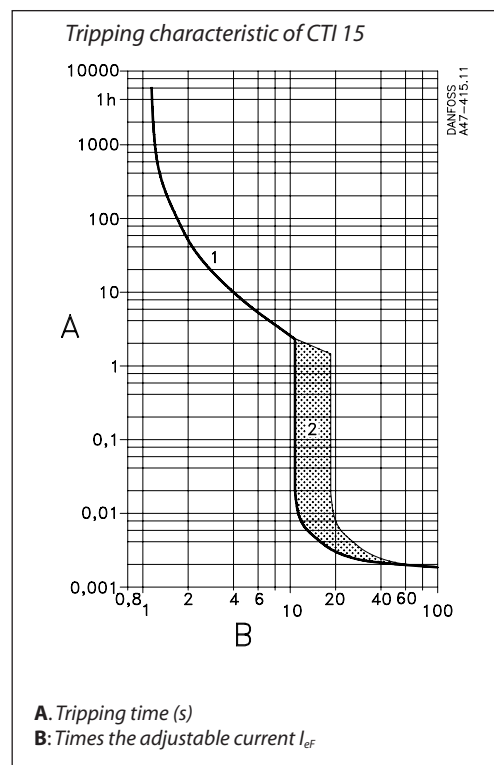

1. Thermal tripping current

The adjustable, current-dependent, delayed bimetal breakers guarantee motor overload protection.

The graph gives the average value at 20°C ambient temperature, from the cold condition. When the unit has warmed up, the release time is less or equal to the release time in the cold condition.

The accurate adjustment ensures motor protection even in the event of phase failure.

2. Magnetic tripping current

The electromagnetic, instantaneous high-speed trips react at a fixed response current. At the highest setting value this corresponds to 11 times the set current for CTI 15. At a lower setting it is correspondingly higher.

Short-circuit protection

It has become more and more general to short-circuit-protect panels with circuit breakers rather than fuses. The clear advantages of "fuse-free" installations are:

- Space saving
- Cut-out in all three phases in the event of short-circuiting.
- No problems with non-convertible fuse types when exporting electrical equipment.

Danfoss circuit breakers CTI 15 conform to IEC 947-2 and are tested in accordance with EN 60947-2. Because of their fast reaction times and reliability they are particularly suitable for the short-circuit protection of panels.

Fuseless coordination tables *Circuit breakers and contactors*

Prospective short circuit current: $I_q = 10/ 50 \text{ kA}$
 Voltage: 380 - 415 V/ 50 Hz
 Overload and short circuit protection with circuit breaker type: CTI
 Short circuit coordination: T1

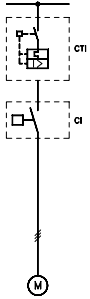

Contactor type	Short circuit coordination type T1	
	Test current "r" ¹⁾ and I _q = 50 kA	
	Maximum CTI - range A	
CI 4-2, CI 4-5, CI 4-9	16 ²⁾	
CI 6, CI 9	16 ²⁾	
CI 12, CI 15	16 ²⁾	
CI 16	16 ²⁾	
CI 20, CI 25	16 ²⁾	

¹⁾ Short circuit test current according to EN 60947-4 (see table page 8)
²⁾ Fuses should be installed in the front of CTI 15 with higher ratings than 6.3 A when rated service breaking capacity exceed values in tables page 9.

Fuseless coordination tables *Circuit breakers, contactors and thermal overload relays (several groups)*

Prospective short circuit current: $I_q = 50 \text{ kA}$
 Voltage: 380-415 V/ 50 Hz
 Overload protection with thermal overload relay type: TI
 Short circuit protection with circuit breaker type: CTI
 Short circuit coordination: T1

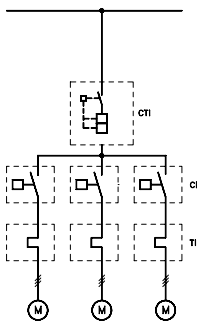

Contactor type	Thermal overload relay Range A	Test current "r" ¹⁾ and I _q = 50 kA
		Maximum CTI - range A
CI 4-5, CI 6, CI 9	0.13 - 0.20	CTI 15 - 16 A ²⁾
CI 4-5, CI 6, CI 9	0.19 - 0.29	
CI 4-5, CI 6, CI 9	0.27 - 0.42	
CI 4-5, CI 6, CI 9	0.4 - 0.62	
CI 4-5, CI 6, CI 9	0.6 - 0.92	
CI 4-5, CI 6, CI 9	0.85 - 1.3	CTI 15 - 16 A ²⁾
CI 4-5, CI 6, CI 9	1.2 - 1.9	
CI 4-5, CI 6, CI 9	1.8 - 2.8	
CI 4-5, CI 6, CI 9	2.7 - 4.2	
CI 4-5, CI 6, CI 9	4 - 6.2	
CI 4-9, CI 9	6 - 9.2	
CI 12, CI 15	8 - 12	
CI 15, CI 16	11 - 16	CTI 15 - 16 A ²⁾

¹⁾ Short circuit test current according to EN 60947-4 (see table page 8)
²⁾ Fuses should be installed in the front of CTI 15 with higher ratings than 6.3 A when rated service breaking capacity exceed values in tables on page 9.

Coordination tables with fuses

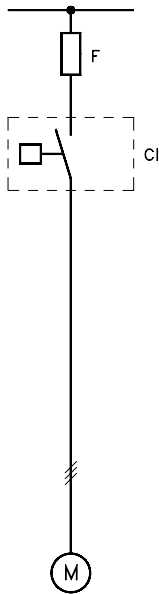

Contactor

Prospective short circuit current:

Voltage:

Overload and short circuit protection with fuse types:

Short circuit coordination:

$I_q = 10/ 50 \text{ kA}$

380 - 415 V/ 50 Hz

gL, gL, gG and 'T' (BS 88)

T1

Contactor type	Short circuit coordination type	
	T1	
	Test Current	
	"r" ¹⁾ and $I_q = 50 \text{ kA}$	
	gL,gL,gG	'T'
	A	A
CI 4-2, CI 4-5, CI 4-9	50	63
CI 6, CI 9, CI 12, CI 15	50	63
CI 16	80	80
CI 20, CI 25	80	80
CI 30	80	80
CI 32	125	125
CI 37, CI 45, CI 50	125	125
CI 61, CI 73	250	
CI 105	250	
CI 141	315	
CI 170 EI	355	
CI 210 EI, CI 250 EI	500	
CI 300 EI, CI 420 EI	630	

¹⁾ Short circuit test current according to EN 60947-4 (see table page 7)

Coordination tables with fuses

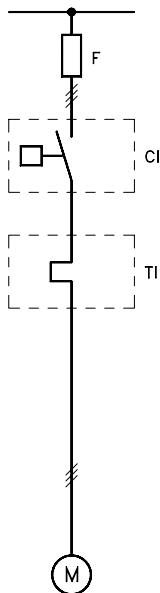

Thermal overload relays and contactors

Prospective short circuit current:

Voltage:

Overload and short circuit protection with fuse types:

Short circuit coordination:

$I_q = 10/ 50 \text{ kA}$

380 - 415 V/ 50 Hz

gL, gL, gG and 'T' (BS 88)

T1

Contactor type	Thermal over-load relay	Short circuit coordination type	
		T1	
		Test Current	
		"r" ¹⁾ and $I_q = 50 \text{ kA}$	
	A	gL,gL,gG	'T'
	A	A	A
CI 4-5, CI 4-9, CI 6, CI 9	0.13-0.20	25	32
CI 4-5, CI 4-9, CI 6, CI 9	0.19-0.29	25	32
CI 4-5, CI 4-9, CI 6, CI 9	0.27-0.42	25	32
CI 4-5, CI 4-9, CI 6, CI 9	0.42-0.60	25	32
CI 4-5, CI 4-9, CI 6, CI 9	0.60-0.92	25	32
CI 4-5, CI 4-9, CI 6, CI 9	0.85-1.3	25	32
CI 4-5, CI 4-9, CI 6, CI 9	1.2-1.9	25	32
CI 4-5, CI 4-9, CI 6, CI 9	1.8-2.8	25	32
CI 4-5, CI 4-9, CI 6, CI 9	2.7-4.2	25	32
CI 4-5, CI 4-9, CI 6, CI 9	4-6.2	35	40
CI 4-9, CI 9	6-9.2	0	50
CI 12, CI 15	8-12	63	63
CI 15, CI 16	11-16	80	80
CI 16, CI 20	15-20	80	80
CI 25	19-25	80	80
CI 30	24-32	80	80
CI 32	16-23	125	125
CI 32	22-32	125	125
CI 37, CI 45	30-45	125	125
CI 50	42-63	125	125
CI 61	42-63		100
CI 73	60-80		125
CI 86	74-85		125
CI 105	68-90		
CI 105	85-110		
CI 85, CI 105	20-180	250	
CI 140, CI 140 EI	20-180	315	
CI 170, CI 170 EI	20-180	355	
CI 210, CI 250 EI	160-630	500	
CI 300, CI 420 EI	160-630	630	

¹⁾ Short circuit test current according to EN 60947-4 (see table page 7)

Coordination tables with fuses or circuit breakers/MCB

Auxiliary contacts
 Prospective short-circuit current: $I_q = 1 \text{ kA}$
 Coordination type "weld-free"
 Fuse, types gL, gL, gG, 'T' (BS 88)

For unit type	Auxiliary contacts		Max. permissible fuse		MCCB	
	Clip-on	Build-in	gL, gL, gG A	'T' A	Let-throug energy A ² s	Max. CTI-range A
CI 6		●	10	16	400	2
CI 4-2, CI 4-5, CI 4-9	CBM-		10	16	400	2
		●	16	20	900	4
CI 6, CI 9, CI 12, CI 15		S	6	10	130	1
CI 16, CI 20, CI 25, CI 30	CB-	NO-NC	16	20	900	4
CI 32, CI 37, CI 45, CI 50		EM-LB	25	32	3000	25
CI 61, CI 73, CI 86	CBD -		10	16	400	2
		●	25	32	3000	25
CI 105, CI 141, CI 170 EI	CBC -	●	16	20	900	4
CTI 15	CBI -		16	20	900	4
CTI 100	CBI 100 -		16	20	900	4

**Dimensions
Circuit breakers CTI**

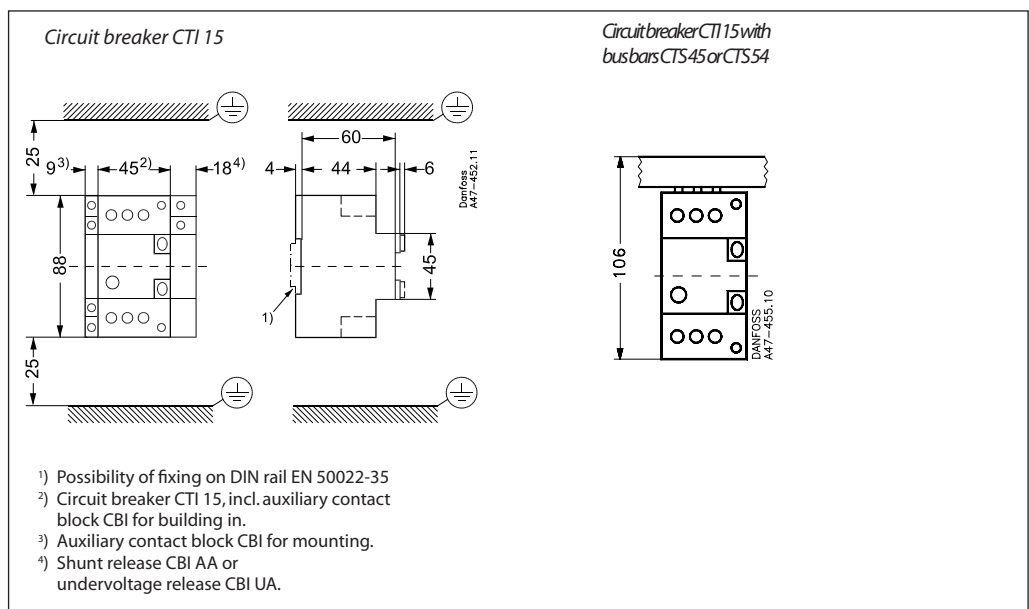

Danfoss can accept no responsibility for possible errors in catalogues, brochures and other printed material. Danfoss reserves the right to alter its products without notice. This also applies to products already on order provided that such alterations can be made without consequential changes being necessary in specifications already agreed. All trademarks in this material are property of the respective companies. Danfoss and the Danfoss logotype are trademarks of Danfoss A/S. All rights reserved.