

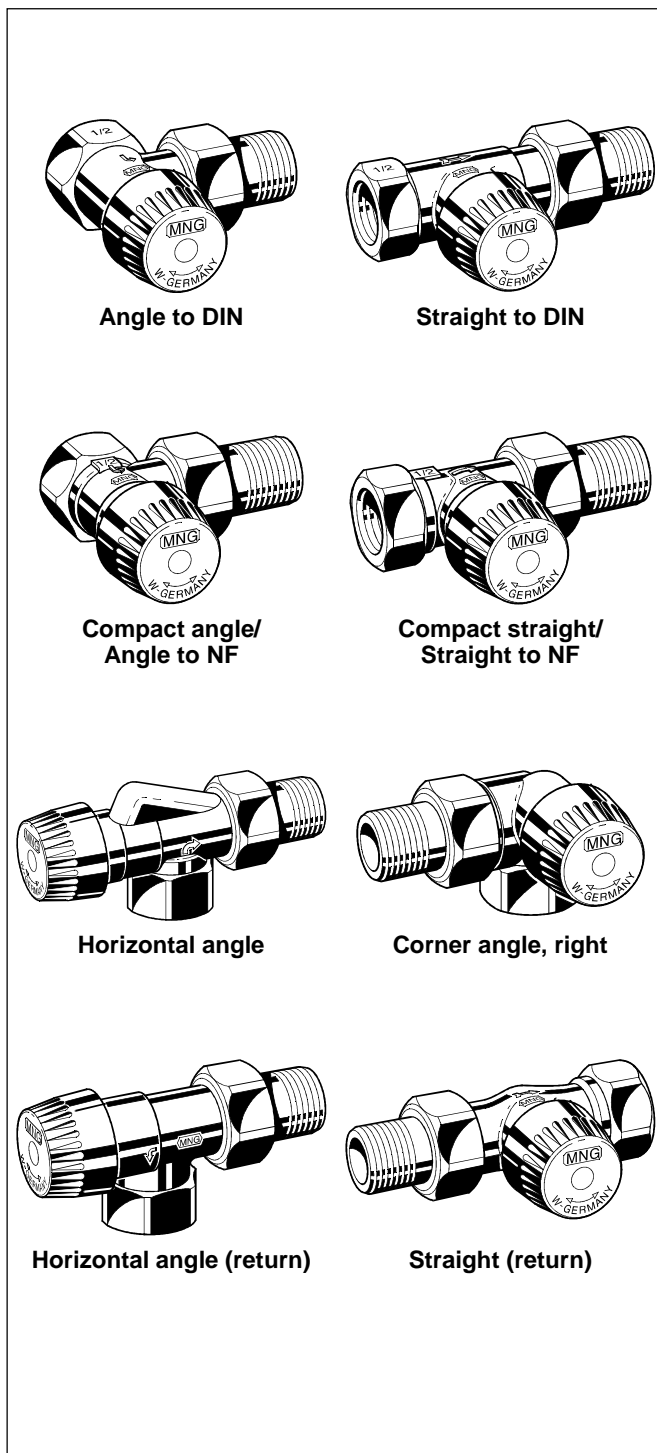

V2000VS V type TRV Body

RADIATOR VALVE WITH PRE-SETTABLE CARTRIDGE

PRODUCT DATA



Application

Thermostatic radiator valve bodies (TRV bodies) are fitted on the supply or return of radiators or heat exchangers. Together with a radiator thermostat, for example the Thera-3, they control the room temperature by regulating the flow of hot water into the heat exchanger. The temperature of different rooms is controlled individually and energy is saved.

V type TRV bodies have quiet operation and are fitted to the supply or return of radiators in two-pipe systems with medium flow rates. The pre-setting function allows to throttle the flow through the valve by pre-setting it.

The valve insert can be replaced while the system is running and without draining using the service tool (see 'Accessories' on page 4).

V type TRV bodies are suitable for

- Honeywell radiator thermostats with M30 x 1,5 connection;
- Honeywell M100, Z100 and various M7410 actuators;
- Honeywell **Hometronic** HR50 and **Roomtronic** HR40 actuators.

AT-Concept

AT-Concept valves share the same valve housing design. The valve insert can be replaced by any other AT-Concept valve insert, i.e. BB, KV, UBG, GB, SL, FV and SC.

Features

- Pre-settable fine-adjustment valve disc
- Tamper proof pre-setting
- Pre-setting is visible when thermostat is removed
- For heating systems with medium flow rates
- Available for installation in the supply or in the return
- Quiet operation
- DIN type bodies with dimensions according to HD1215, Part 2, Series D
- NF type bodies with dimensions according to HD 1215, Part 2, Series F
- AT-Concept valve housing and insert
- Valve insert can be replaced while system is operating and without draining the system
- Valve opening spring is not in the water
- Standard M30 x 1,5 thermostat connection
- Supplied with beige protection cap, 'V' embossed for clear identification

Overleaf: Design, Materials, Specifications and Function

Design

The thermostatic radiator valve body consists of:

- Valve housing PN10, DN10, 15 or 20 with
 - internal thread connection to DIN2999 (ISO7) for threaded, copper or precision steel pipe on inlet¹ (compression ring fittings see 'Accessories' on page 4); and
 - external thread connection to DIN/ISO228 with union-nut and radiator tailpiece on outlet¹ (Eurocone).
 - Angle to DIN and straight to DIN bodies with dimensions according to HD1215, Part 2, Series D.
 - Angle to NF and straight to NF bodies with dimensions according to HD1215, Part 2, Series F.
- Valve insert with V type cartridge
- Protection cap
- Union-nut and radiator tailpiece

NOTE: ¹Vice versa for return type valve bodies.

Materials

- Angle/straight to DIN, horizontal angle (return) and straight (return): valve housings made of nickel-plated red bronze
- Compact angle/straight, angle/straight to NF, corner angle and horizontal angle: valve housing made of nickel-plated hot-forged brass
- Valve insert made of brass with EPDM O-rings and soft seals, brass spindle and plastic pre-setting ring
- Protection cap made of beige plastic
- Union-nut and tailpiece made of brass, union-nut nickel-plated

Dimensions and Ordering Information

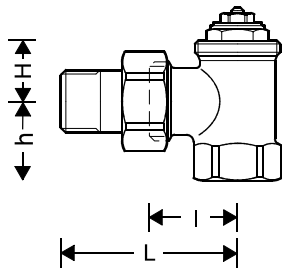

Fig. 1. Angle

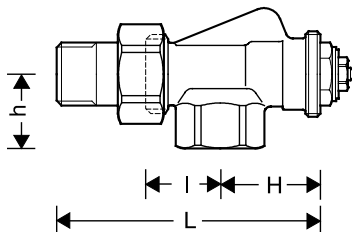

Fig. 3. Horizontal angle

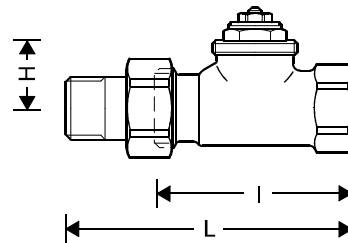

Fig. 2. Straight

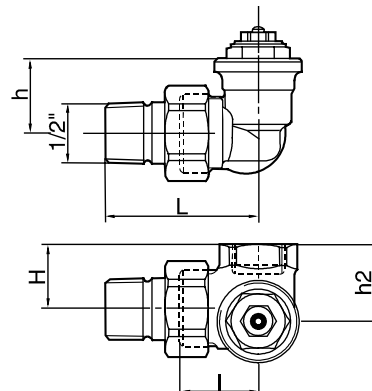

Fig. 4. Corner angle

Specifications

Medium	Heating water, water quality to VDI2035
Operating temperature	max. 130°C (266°F)
Operating pressure	max. 10 bar (145 psi)
Differential pressure	max. 2 bar (29 psi) – max. 0,2 bar (2,9 psi) recommended for quiet operation
kvs (cv)-value	0,72 (0,84)
Body to head thread	M30 x 1,5
Closing dimension	11,5 mm
Stroke	2,5 mm

Identification

- Beige protection cap, 'V' embossed on top
- Beige scale on top of valve insert

Function

Thermostatic radiator valves enable individual control of room temperature and thus save energy.

The TRV body is controlled by the radiator thermostat. Air from the room passing over the sensor of the radiator thermostat causes the sensor to expand when the temperature rises. The sensor acts onto the valve spindle and this causes the TRV body to close. When the temperature falls the sensor contracts and the spring-loaded valve spindle is opened. The TRV opens in proportion to the temperature of the sensor. Only the amount of water required to maintain the room temperature set on the radiator thermostat can flow into the radiator.

Table 1. Dimensions and OS-Nos (OS=Ordering System)

Body type	DN	k _{vs} -value	Pipe connection	l	L	h	H	h ₂	OS-No.
For the supply									
Angle to DIN (Fig. 1)	10	0,72	Rp 3/8"	26	52	20	22	—	V2000EVS10 ²
	15	0,72	Rp 1/2"	29	58	20	26	—	V2000EVS15 ²
	20	0,72	Rp 3/4"	34	66	19	29	—	V2000EVS20 ²
Straight to DIN (Fig. 2)	10	0,72	Rp 3/8"	59	85	25	—	—	V2000DVS10 ²
	15	0,72	Rp 1/2"	66	95	25	—	—	V2000DVS15 ²
	20	0,72	Rp 3/4"	74	106	25	—	—	V2000DVS20 ²
Angle, compact dimensions (Fig. 1)	10	0,72	Rp 3/8"	24	55,5	22	20	—	V2010EVS10
	15	0,72	Rp 1/2"	26	59,5	23	23	—	V2010EVS15
Straight, compact dimensions (Fig. 2)	10	0,72	Rp 3/8"	50	81,5	27	—	—	V2010DVS10
	15	0,72	Rp 1/2"	55	88,5	27	—	—	V2010DVS15
Angle to NF (Fig. 1)	10	0,72	Rp 3/8"	24	55,5	22	20	—	V2020EVS10 ²
	15	0,72	Rp 1/2"	26	59,5	23	23	—	V2020EVS15 ²
Straight to NF (Fig. 2)	10	0,72	Rp 3/8"	50	81,5	27	—	—	V2020DVS10 ²
	15	0,72	Rp 1/2"	55	88,5	27	—	—	V2020DVS15 ²
Horizontal angle (Fig. 3)	10	0,72	Rp 3/8"	24	50	33	22	—	V2000AVS10 ²
	15	0,72	Rp 1/2"	26	54	35	26	—	V2000AVS15 ²
Corner angle, radiator connection left (Fig. 4)	10	0,72	Rp 3/8"	24	53	26	22	26,5	V2000LVS10
	15	0,72	Rp 1/2"	24	53	26	26	30,5	V2000LVS15
radiator connection right (Fig. 4)	10	0,72	Rp 3/8"	24	53	26	22	26,5	V2000RVS10
	15	0,72	Rp 1/2"	24	53	26	26	30,5	V2000RVS15
For the return									
Horizontal angle (Fig. 3)	10	0,72	Rp 3/8"	25	52	21	22	—	V2000HVS10
	15	0,72	Rp 1/2"	29	58	23	26	—	V2000HVS15
Straight (Fig. 2)	10	0,72	Rp 3/8"	57	85	23	—	—	V2000IVS10
	15	0,72	Rp 1/2"	65	95	23	—	—	V2000IVS15

NOTE: All dimensions in mm unless otherwise stated.

NOTE: ²Alternatively available with nickel-plated radiator tailpiece. Please change OS-No. to V2002... Other bodies also available with nickel-plated radiator tailpiece on request.

Accessories

Pipe Connections

Compression ring and nut

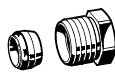
	3/8" x 10 mm	VA620A1010
	3/8" x 12 mm	VA620A1012
	1/2" x 10 mm	VA620A1510
	1/2" x 12 mm	VA620A1512
	1/2" x 14 mm	VA620A1514
	1/2" x 15 mm	VA620A1515
	1/2" x 16 mm	VA620A1516
	3/4" x 18 mm	VA620A2018
	3/4" x 22 mm	VA620A2022

NOTE: Support inserts have to be used for copper or soft steel pipe with 1,0 mm wall thickness.

Compression ring and nut with support insert (2 pcs each)

	3/8" x 12 mm	VA621A1012
	1/2" x 12 mm	VA621A1512
	1/2" x 15 mm	VA621A1515
	1/2" x 16 mm	VA621A1516
	3/4" x 18 mm	VA621A2018

Reduction piece

	1" pipe > 1/2" valve	VA6290A260
	1 1/4" pipe > 1/2" valve	VA6290A280
	1" pipe > 3/4" valve	VA6290A285
	1 1/4" pipe > 3/4" valve	VA6290A305

Radiator tailpiece with thread up to collar

	for valves DN 10 (3/8")	VA5201A010
	for valves DN 15 (1/2")	VA5201A015
	for valves DN 20 (3/4")	VA5201A020

Extended radiator tailpiece, to be shortened as required

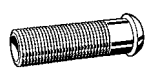
	3/8" x 70 mm (for DN 10), thread approx. 50 mm	VA5204A010
	1/2" x 76 mm (for DN 15), thread approx. 65 mm	VA5204A015
	3/4" x 70 mm (for DN 20), thread approx. 60 mm	VA5204A020

Soldering tailpiece

	3/8" x 12 mm (for DN 10)	VA5230A010
	1/2" x 15 mm (for DN 15)	VA5230A015
	3/4" x 20 mm (for DN 20)	VA5230A020

Valve Accessories

Manual handwheel cap

	Pre-settable, with integrated locking device	VA2200D001
---	--	------------

Pressure cap – for shutting off valves on radiator outlet

	for valves DN10 (3/8")	VA2202A010
	for valves DN15 (1/2")	VA2202A015
	for valves DN20 (3/4")	VA2202A020

Sealing ring for pressure cap

	for valves DN10 (3/8")	VA5090A010
	for valves DN15 (1/2")	VA5090A015
	for valves DN20 (3/4")	VA5090A020

Service tool for replacing valve insert without draining system

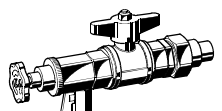
	for all sizes	VA8200A001
--	---------------	------------

Pre-setting key

	for all sizes	VA8201FV02
---	---------------	------------

Replacement valve insert

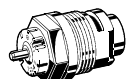
	for all sizes	VS1200VS01
---	---------------	------------

Flow Data

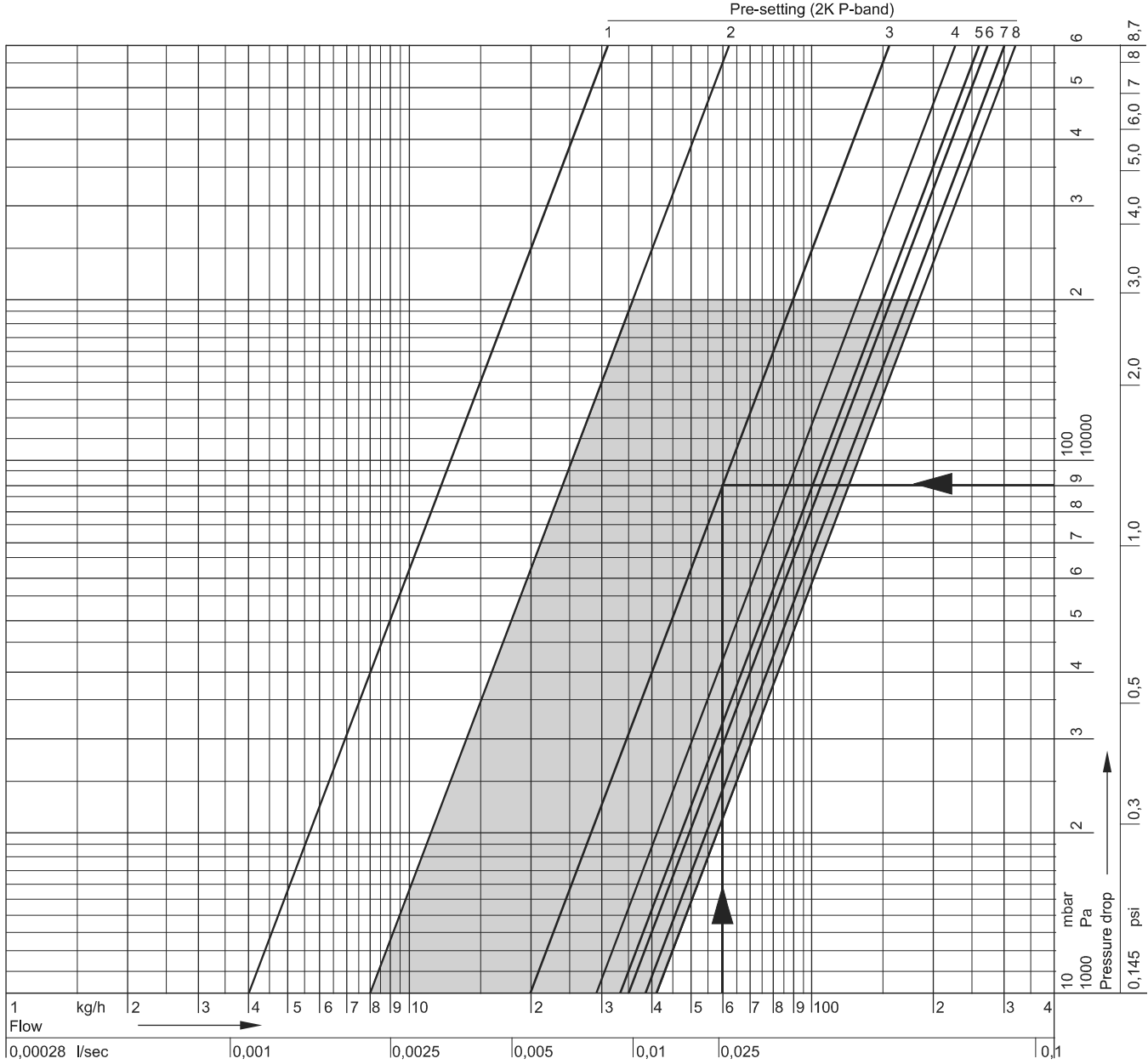

■ recommended range of operation

Pre-setting	1	2	3	4	5	6	7	8 ³
xP = 1K (m ³ /h)	0,04	0,06	0,13	0,16	0,19	0,19	0,19	0,19
xP = 2K (m ³ /h)	0,04	0,08	0,20	0,29	0,33	0,35	0,38	0,41
kvs-value (m ³ /h)	0,04	0,09	0,22	0,35	0,43	0,51	0,62	0,72

NOTE: ³ Factory setting.

Design Example

- Given flow rate: 60 kg/h
- Required: Pre-setting for a required pressure loss $\Delta p = 90 \text{ mbar} = 9000 \text{ Pa}$ with a P-band of 2K
- Solution: The required pressure loss is found at the intersection of the flow line with the line for the chosen valve performance P=2K
- Result: Pre-setting 3

Installation Examples

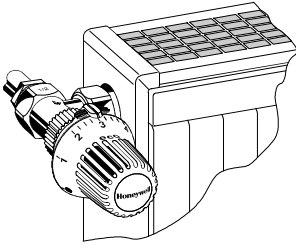

Fig. 5 Angle

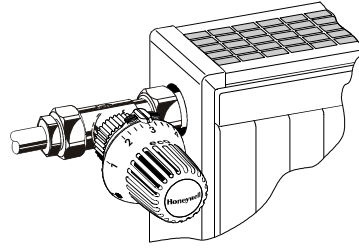

Fig. 6 Straight

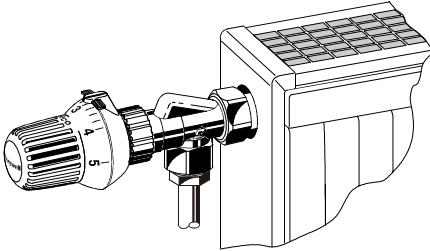

Fig. 7 Horizontal angle

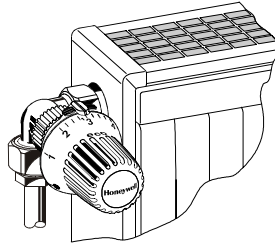

Fig. 8 Double angle

Honeywell

Control Products

Honeywell AG
Zu den Ruhrwiesen 3
D-59755 Arnsberg-Neheim

Phone: (49) 2932 9880
Fax: (49) 2932 988239
mng@honeywell.com

<http://europe.hbc.honeywell.com>