

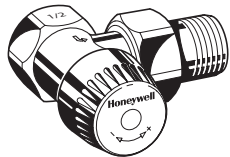

V2000UB UBG type TRV Body

RADIATOR VALVE WITH UNLIMITED CARTRIDGE

PRODUCT DATA



Angle to DIN

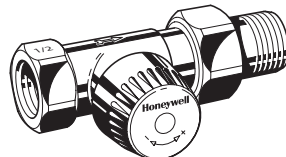

Straight to DIN

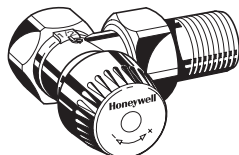

Angle to NF

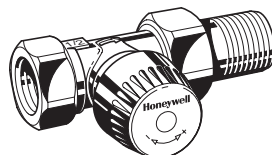

Straight to NF

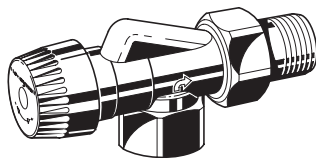

Horizontal angle

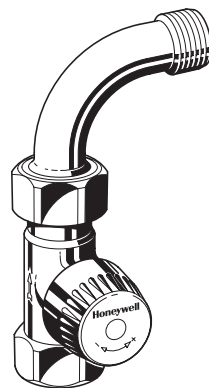

Straight with swanneck

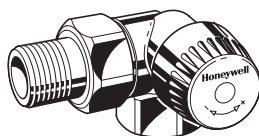

Corner angle

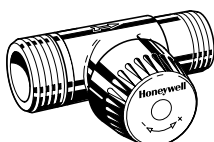

Straight with external threads

Application

Thermostatic radiator valve bodies (TRV bodies) are fitted on the supply or return of radiators or heat exchangers. Together with a radiator thermostat, for example the Thera-4, they control the room temperature by regulating the flow of hot water into the radiator. The temperature of different rooms is controlled individually and energy is saved.

TRV bodies of this type have quiet operation and are fitted to the supply of radiators in one-pipe systems or in two-pipe systems with medium to high flow rates.

The valve insert can be replaced while the system is running and without draining using the service tool (see 'Accessories').

TRV bodies of this type are suitable for

- Honeywell radiator thermostats with M30 x 1.5 connection
- Certain Honeywell MT4 actuators
- Honeywell Hometronic HR80 and Roomtronic HR40 actuators

AT-Concept

AT-Concept valves share the same valve housing design. The valve insert can be replaced by any other AT-Concept valve insert, i.e. BB, KV, UBG, SL, VS, FS, FV and SC.

Features

- For one-pipe heating systems and two-pipe systems with medium to high flow rates
- Quiet operation
- DIN type bodies with dimensions according to EN215, Appendix A, Series D
- NF type bodies with dimensions according to EN215, Appendix A, Series F
- AT-Concept valve housing and insert
- Valve insert can be replaced while system is operating and without draining the system
- Valve opening spring is not in the water
- Standard M30 x 1.5 thermostat connection
- Supplied with white protection cap for clear identification

Design

The thermostatic radiator valve body consists of:

- Valve housing PN10, DN10, 15, 20 or 25 with
 - internal thread connection to DIN2999 (ISO7) for threaded, copper or precision steel pipe on inlet¹ (compression ring fittings see 'Accessories')
 - external thread connection with union-nut and radiator tail-piece on outlet¹ (Eurocone for DN15) or
 - external thread connections on inlet and outlet, without union-nut and radiator tailpiece
 - angle to DIN and straight to DIN bodies with dimensions according to EN215, Appendix A, Series D
 - angle to NF and straight to NF bodies with dimensions according to EN215, Appendix A, Series F
- Valve insert with UBG (unlimited flow) type cartridge
- Protection cap
- Union-nut and radiator tailpiece

Materials

- Angle/straight to DIN and straight with external threads: valve housing made of nickel-plated red bronze
- Compact angle/straight, angle/straight to NF, corner angle, horizontal angle and swanneck tailpiece: valve housing made of nickel-plated hot-forged brass
- Valve insert made of brass with EPDM O-rings and soft seals and stainless steel spindle
- Protection cap made of white plastic
- Union-nut and tailpiece made of nickel-plated brass

Please Note:

- To avoid stone deposit and corrosion the composition of the medium should conform with VDI-Guideline 2035
- Additives have to be suitable for EPDM sealings
- System has to be flushed thoroughly before initial operation with all valves fully open
- Any complaints or costs resulting from non-compliance with above rules will not be accepted by Honeywell
- Please contact us if you should have any special requirements or needs

Specifications

Medium	Heating water, water quality to VDI2035
Operating temperature	max. 130°C (266°F)
Operating pressure	PN10
Differential pressure	max. 1 bar (14.5 psi) – max. 0.2 bar (2.9 psi) recommended for quiet operation
k_v(cv)-value	0.8...2.5 (0.94...2.93) depending on type of valve body (see „Dimensions“)
Nominal flow	190 kg/h
Thermostat connection	M30 x 1.5
Closing dimension	11.5 mm
Stroke	2.5 mm

Identification

- White protection cap
- Brass insert

Function

Thermostatic radiator valves enable individual control of room temperature and thus save energy.

The TRV body is controlled by the radiator thermostat. Air from the room passing over the sensor of the radiator thermostat causes the sensor to expand when the temperature rises. The sensor acts onto the valve spindle and this causes the TRV body to close. When the temperature falls the sensor contracts and the spring-loaded valve spindle is opened. The TRV opens in proportion to the temperature of the sensor. Only the amount of water required to maintain the room temperature set on the radiator thermostat can flow into the radiator.

Installation Examples

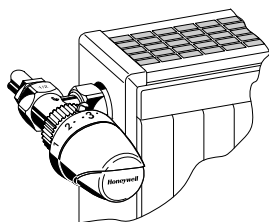

Fig. 1. Angle

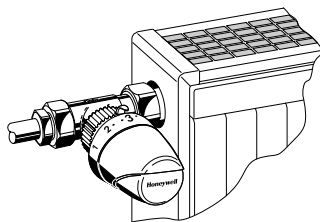

Fig. 2. Straight

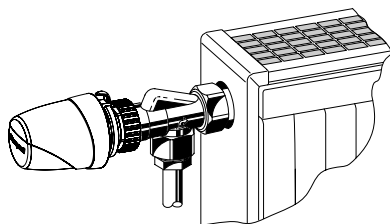

Fig. 3. Horizontal angle

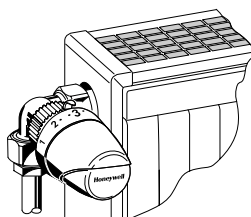

Fig. 4. Corner angle

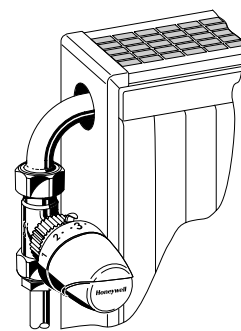

Fig. 5. Straight with swanneck

Dimensions and Ordering Information

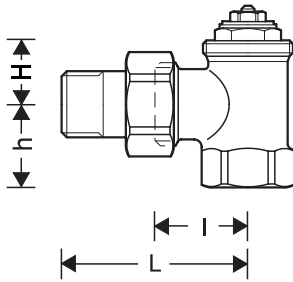

Fig. 6. Angle

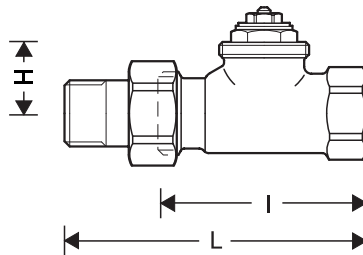

Fig. 7. Straight

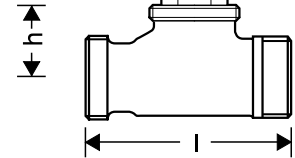

Fig. 8. Straight with external threads

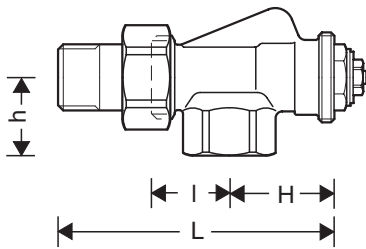

Fig. 9. Horizontal angle

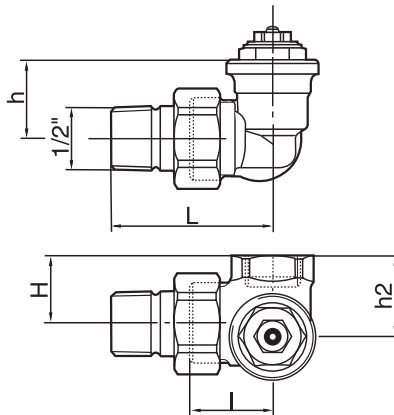

Fig. 10. Corner angle

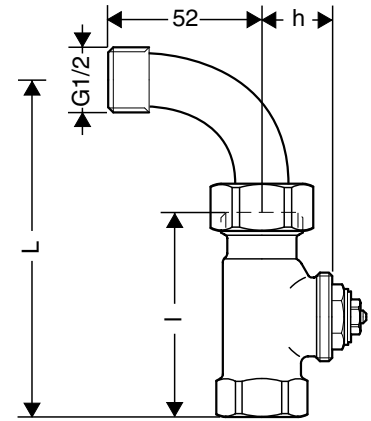

Fig. 11. Straight with swanneck

Table 1. Dimensions and OS-Nos (OS=Ordering System)

Body type	DN	EN215 certified	k _{vs} (cv)-value	Pipe connection	l	L	h	H	h ₂	OS-No.
For the supply										
Angle to EN215 (D) (Fig. 6)	10	•	1.70 (1.99)	Rp 3/8"	26	52	22	20	—	V2000EUB10
	15	•	1.85 (2.16)	Rp 1/2"	29	58	26	20	—	V2000EUB15
	20	•	1.95 (2.28)	Rp 3/4"	34	66	29	19	—	V2000EUB20
	25	•	2.20 (2.57)	Rp1"	41.5	73	33	26	—	v2000EUB25
Straight to EN215 (D) (Fig. 7)	10	•	1.70 (1.99)	Rp 3/8"	59	85	—	25	—	V2000DUB10
	15	•	1.85 (2.16)	Rp 1/2"	66	95	—	25	—	V2000DUB15
	20	•	1.95 (2.28)	Rp 3/4"	74	106	—	25	—	V2000DUB20
	25	•	2.20 (2.57)	Rp1"	80	112.5	—	30	—	V2000DUB25
Angle to EN215 (F) (Fig. 6)	10	•	1.80 (2.11)	Rp 3/8"	24	49	20	21	—	V2020EUB10
	15	•	1.80 (2.11)	Rp 1/2"	26	53	23	22	—	V2020EUB15
	20	•	1.95 (2.28)	Rp 3/4"	34	66	29	18	—	V2020EUB20
Straight to EN215 (F) (Fig. 7)	10	•	0.80 (0.94)	Rp 3/8"	50	75	—	26	—	V2020DUB10
	15	•	1.10 (1.29)	Rp 1/2"	55	82	—	26	—	V2020DUB15
	20	•	1.95 (2.28)	Rp 3/4"	74	106	—	24	—	V2020DUB20
Horizontal angle (Fig. 9)	10	•	1.20 (1.40)	Rp 3/8"	24	50	22	33	—	V2000AUB10
	15	•	1.20 (1.40)	Rp 1/2"	26	54	26	35	—	V2000AUB15
Corner angle, radiator connection left (Fig. 10)	10	•	1.00 (1.17)	Rp 3/8"	24	53	26	22	26.5	V2000LUB10
	15	•	1.00 (1.17)	Rp 1/2"	24	53	26	26	30.5	V2000LUB15
Corner angle, radiator connection right (Fig. 10)	10	•	1.00 (1.17)	Rp 3/8"	24	53	26	22	26.5	V2000RUB10
	15	•	1.00 (1.17)	Rp 1/2"	24	53	26	26	30.5	V2000RUB15
Swanneck (Fig. 11)	15	•	1.60 (1.87)	Rp 1/2"	66	108	25	—	—	V2000BUB15
For the supply or return										
Straight with external threads (Fig. 8)	15	•	1.60 (1.87)	G 3/4" A	66	—	25	—	—	V2060DUB15

NOTE: All dimensions in mm unless stated otherwise.

Accessories

Pipe Connections

Compression ring and nut

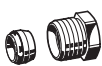
	3/8" x 10 mm	VA620A1010
	3/8" x 12 mm	VA620A1012
	1/2" x 10 mm	VA620A1510
	1/2" x 12 mm	VA620A1512
	1/2" x 14 mm	VA620A1514
	1/2" x 15 mm	VA620A1515
	1/2" x 16 mm	VA620A1516
	3/4" x 18 mm	VA620A2018
	3/4" x 22 mm	VA620A2022

NOTE: Support inserts have to be used for copper or soft steel pipe with 1.0 mm wall thickness

Compression ring and nut with support insert (2 pcs each)

	3/8" x 12 mm	VA621A1012
	1/2" x 12 mm	VA621A1512
	1/2" x 15 mm	VA621A1515
	1/2" x 16 mm	VA621A1516
	3/4" x 18 mm	VA621A2018

Compression ring and nut with support insert for composite pipe (2 pcs each)

	1/2" x 14 mm	VA622B1514
	1/2" x 16 mm	VA622B1516

Radiator tailpiece with thread up to collar

	for valves DN10 (3/8")	VA5201A010
	for valves DN15 (1/2")	VA5201A015
	for valves DN20 (3/4")	VA5201A020

Extended radiator tailpiece, nickel-plated, to be shortened as required

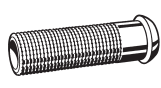
	3/8" x 70 mm (for DN10) thread approx. 50 mm	VA5204A010
	1/2" x 76 mm (for DN15) thread approx. 65 mm	VA5204A015
	3/4" x 70 mm (for DN20) thread approx. 60 mm	VA5204A020

Soldering tailpiece

	3/8" x 12 mm (for DN10)	VA5230A010
	1/2" x 15 mm (for DN15)	VA5230A015
	3/4" x 22 mm (for DN20)	VA5230A020

Valve Accessories

Manual handwheel cap

	Pre-settable, with integrated locking device	VA2200D001
---	--	------------

Pressure cap – for shutting off valves on radiator outlet

	for valves DN10 (3/8")	VA2202A010
	for valves DN15 (1/2")	VA2202A015
	for valves DN20 (3/4")	VA2202A020

Sealing ring for pressure cap

	for valves DN10 (3/8")	VA5090A010
	for valves DN15 (1/2")	VA5090A015
	for valves DN20 (3/4")	VA5090A020

Service tool to replace valve insert

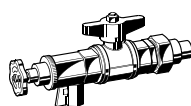
	for all sizes	VA8200A001
---	---------------	------------

Replacement valve insert

	UBG type	VS1200UB01
--	----------	------------

Flow Diagram

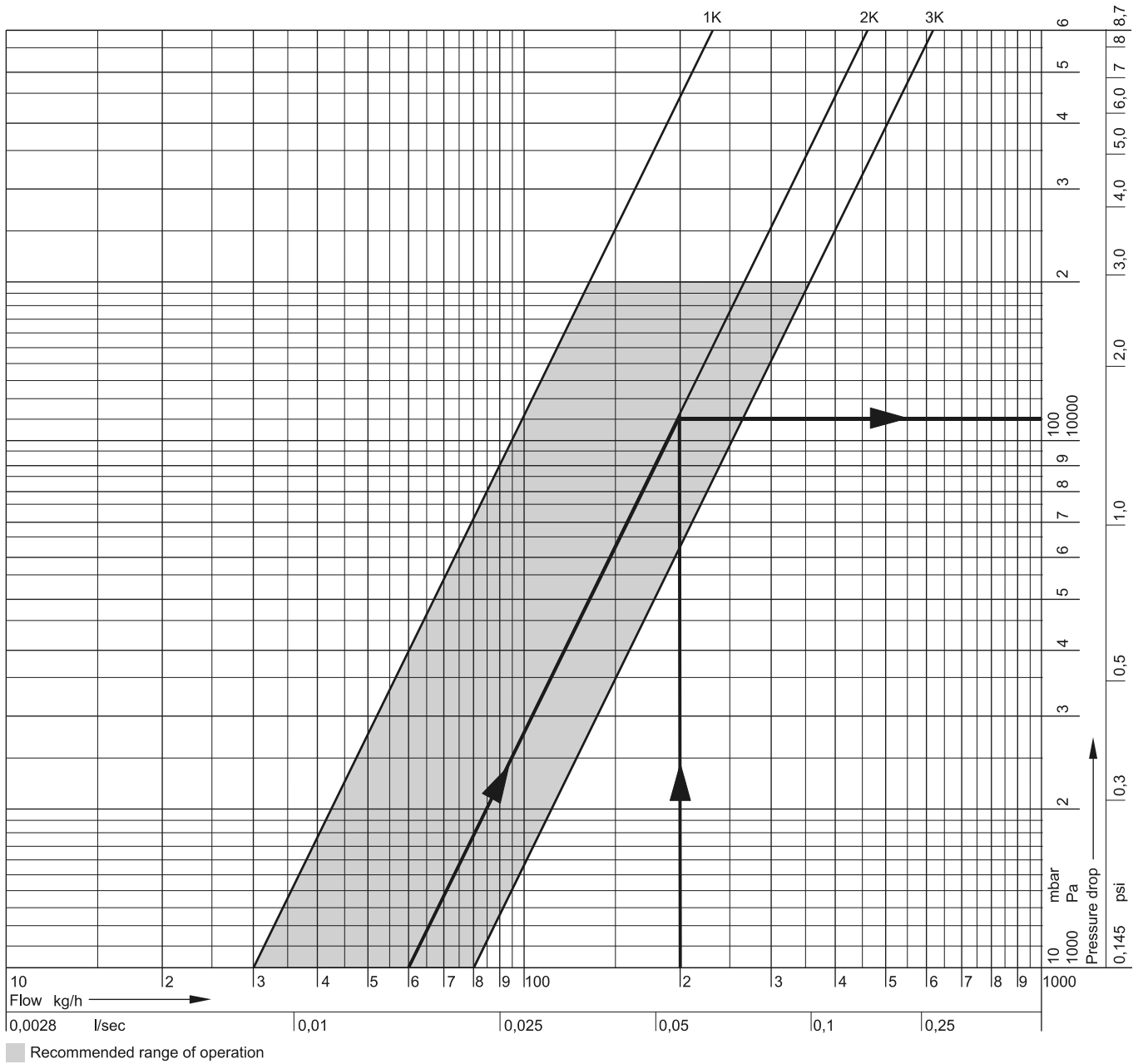

P-Band	1K	2K	3K
k_v-value	0.3	0.6	0.8
cv-value	0.35	0.70	0.94

Design Example

Given: Flow rate 200 kg/h
 Required: Pressure loss (Δp) with a P-band of 2K
 Solution: The required pressure loss is found at the intersection of the flow line with the line for the chosen valve performance P=2K
 Result: $\Delta p = 110 \text{ mbar} = 11\,000 \text{ Pa}$

NOTE: k_{vs} (cv)-values: see Table k_{vs} -(cv)-values

kvs (cv)-values

	DN10 (3/8")	DN15 (1/2")	DN20 (3/4")	DN25 (1")
Angle to DIN	1.70 (1.99)	1.85 (2.16)	1.95 (2.28)	2.20 (2.57)
Straight to DIN	1.70 (1.99)	1.85 (2.16)	1.95 (2.28)	2.20 (2.57)
Angle to NF	1.80 (2.11)	1.80 (2.11)	1.95 (2.28)	—
Straight to NF	0.80 (0.94)	1.10 (1.29)	1.95 (2.28)	—
Horizontal angle	1.20 (1.40)	1.20 (1.40)	—	—
Corner angle	1.00 (1.17)	1.00 (1.17)	—	—
Swanneck	—	1.60 (1.87)	—	—
Straight with external threads	—	1.60 (1.87)	—	—

Automation and Control Solutions

Honeywell GmbH

Hardhofweg

74821 Mosbach, Germany

Phone: +49 (6261) 810

Fax: +49 (6261) 81393

www.honeywell.comEN0H-2101GE25 R0307
March 2007

© 2007 Honeywell International Inc.

Subject to change • All rights reserved

Manufactured for and on behalf of the Environmental and Combustion
Controls Division of Honeywell Technologies Sàrl, Ecublens, Route
du Bois 37, Switzerland or its authorized representative.**Honeywell**