



Actuator for ESBE Slipper Valves up to DN50 AC 230 V

SQK349.00/209

-
- 3-Three-position control
 - Reversible
 - Nominal angular rotation 90°
 - Can be equipped with one auxiliary switch
 - For the motorization of ESBE slipper valves up to DN50
 - For direct assembly with no need for an assembly kit
 - Selector for «AUTO» and «MAN» operation
 - With manual adjuster and position indicator

Use

In heating, ventilating and air conditioning plants for the motorization of ESBE threeport and four-port slipper valves (mixing valves) up to DN50.

Functions

When the actuator receives a control signal from the respective controller, it produces a rotational movement which is transferred to the valve via the coupling mechanism.

The actuator is supplied as follows:

Control signal: Y1 = anticlockwise rotation
0 = no rotation, the respective position is maintained
Y2 = clockwise rotation

The direction of rotation resulting from a certain control signal can be reversed, if required, depending on the hydraulic circuit used. For details, refer to «Commissioning notes» and to the instructions given under the cover of the actuator..

Type summary

Name	Type reference
Actuator	SQK349.00/209
Auxiliary switch (not fitted)	ASC9.7
Screw for three-port mixing valve type F...	4 173 5502 0

Ordering

When ordering, please give name and type reference, e.g. **actuator SQK349.00/209** and **auxiliary switch ASC9.7**.

Actuator and auxiliary switch must be ordered as separate items. They are supplied together but packed separately.

The actuators are supplied in collective packings of 25 pieces which also contain the installation instructions.

When using three-port mixing valves type F..., the screw with part no. 4 173 5502 0 must be ordered separately as this is not included in the standard delivery.

Equipment combinations

Slipper valves (mixing valves)

The following types of ESBE slipper valves can be directly motorized with the SQK349.00/209:

	Type reference	Material	Nominal size	Nominal pressure
Three-port slipper valves	Internally threaded			
	G119	Cast iron	DN20	PN6
	G125	Cast iron	DN25	PN6
	G132	Cast iron	DN32	PN6
	G138	Cast iron	DN40	PN6
	G151	Cast iron	DN50	PN5
	3MG15	Brass	DN15	PN10
	3MG20	Brass	DN20	PN10
	3MG22	Brass	DN20	PN10
	3MG25	Brass	PN25	PN10
	3MG28	Brass	PN25	PN10
	Flanged connections			
	F120	Cast iron	DN20	PN6
	F125	Cast iron	DN25	PN6
	F132	Cast iron	DN32	PN6
	F140	Cast iron	DN40	PN6
	F150	Cast iron	DN50	PN6

Type reference	Material	Nominal size	Nominal ressure
Four-port slipper valves			
Internally threaded			
G419	Cast iron	DN20	PN6
G425	Cast iron	DN25	PN6
G432	Cast iron	DN32	PN6
G438	Cast iron	DN40	PN6
G451	Cast iron	DN50	PN6
4MG15	Brass	DN15	PN10
4MG20	Brass	DN20	PN10
4MG25	Brass	DN25	PN10
BIV25	Cast iron	DN25	PN10
BIV40	Cast iron	DN40	PN10
BIV50	Cast iron	DN50	PN10
TM22	Messing	DN20	PN6
T20	Cast iron	DN20	PN6
T25	Cast iron	DN25	PN6
T32	Cast iron	DN32	PN6
One flanged connection and two internally threaded connections			
FRONT	Cast iron	DN20...50	PN6

Mechanical design

Maintenance-free electric actuator with reversible synchronous motor. The angular rotation of 90° is electrically limited by two limit switches.

A manual setting knob is used for setting the required valve position manually. Manual operation is preselected with the selector having the positions «AUTO» and «MAN». After manual operation, the selector must be reset to «AUTO»

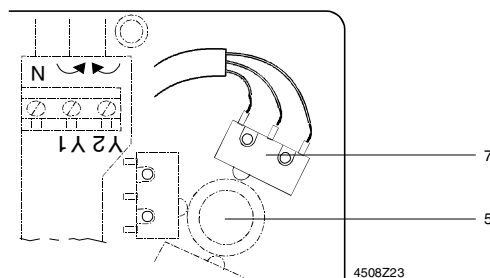
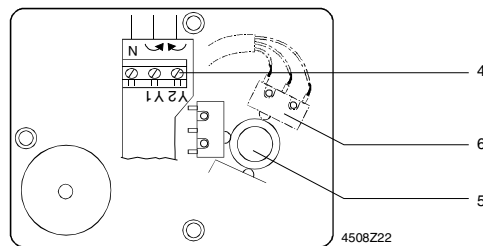
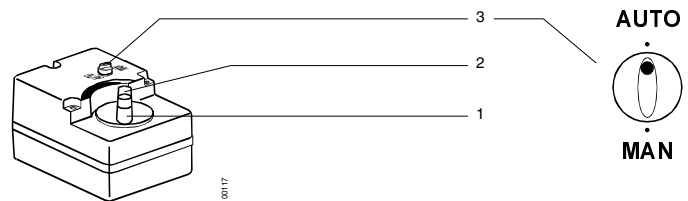

- 1 Manual setting knob
- 2 Position indicator, can be changed manually, depending on the required direction of rotation.
- 3 Selector for automatic or manual operation
- 4 Connecting terminals
- 5 Coupling and cam shaft
- 6 Space for auxiliary switch
- 7 Auxiliary switch ASC9.7.
For on/off or changeover operation. The switching point is adjustable. Factory-wired with a three-wire cable of 1.5 m.

Engineering notes

The permissible ambient temperatures given under „Technical data“ must be observed. If auxiliary functions are required, the actuator must be equipped with an auxiliary switch. In that case, its switching points must be entered in the plant's documentation.

Fitting notes

Actuator positions

The permissible position of the slipper valve must be observed. Details are given in the respective data sheets of the slipper valves.

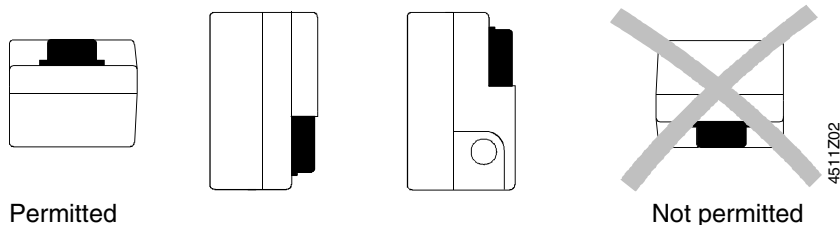

Commissioning notes

When commissioning the plant, check the wiring and carry out a functional test. For automatic operation, the selector must be set to «AUTO»

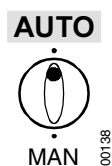

AUTO = automatic operation

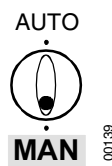

MAN = manual operation

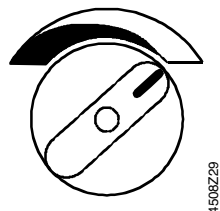

Manual setting «FULLY CLOSED» *)
= no supply of heat

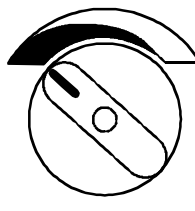

Manual setting «FULLY OPEN»
= maximum supply of heat

*) If the hydraulic circuit is reverse, the removable scale for the position Indicator must be turned.

Direction of rotation

The direction of rotation of the actuator or the slipper valve is determined by the
 – position of the slipper valve (hydraulic circuit)

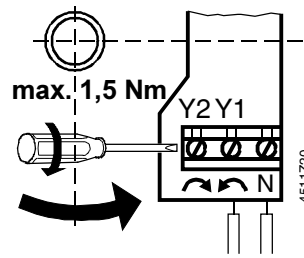

Control signal supplied to terminal Y1
 = anticlockwise rotation *)

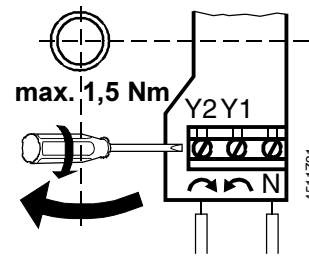

Control signal supplied to terminal Y1
 = clockwise rotation

*) If the hydraulic circuit is reverse, the removable scale for the position indication must be turned

The wiring connecting to terminals Y1 and Y2 must be interchanged if the direction of rotation is to be reversed. If an auxiliary switch is fitted, this aspect must also be taken into consideration when making the electrical connections.

Technical data

Actuator

Operating voltage	AC 230 V $\pm 15\%$
Frequency	50 Hz, or 60 Hz
Mode of control	3-position
Power consumption	3 VA
Running time	Approx. 135 s for 90° rotation
Angular rotation	90° $\pm 3^\circ$ (non-adjustable)
Starting torque	10 Nm
Nominal torque	5 Nm
Perm. ambient temperatures	
Operation	– 15 ... + 50°C
Transport and storage	– 30 ... + 65°C
Perm. Ambient humidity	class D IEC 721 / DIN 40040
Protection standard of housing	IP42 IEC 529 / DIN 40050
Insulation class	II IEC 730 / VDE 0631
Cable entry glands	Pg11 (2x)
Weight	0,5 kg

Auxiliary switch

Switching capacity of ASC9.7	AC 250 V, 6 A (res.), 2 A (ind.)
------------------------------	----------------------------------

Internal diagram

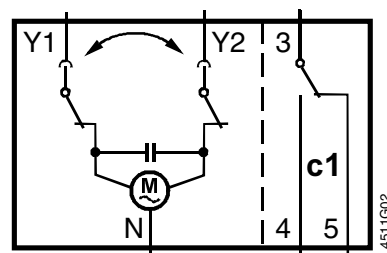

C1 = auxiliary switch ASC9.7

SQK349.00/209 (AC 230 V)

Dimensions

Dimensions in mm

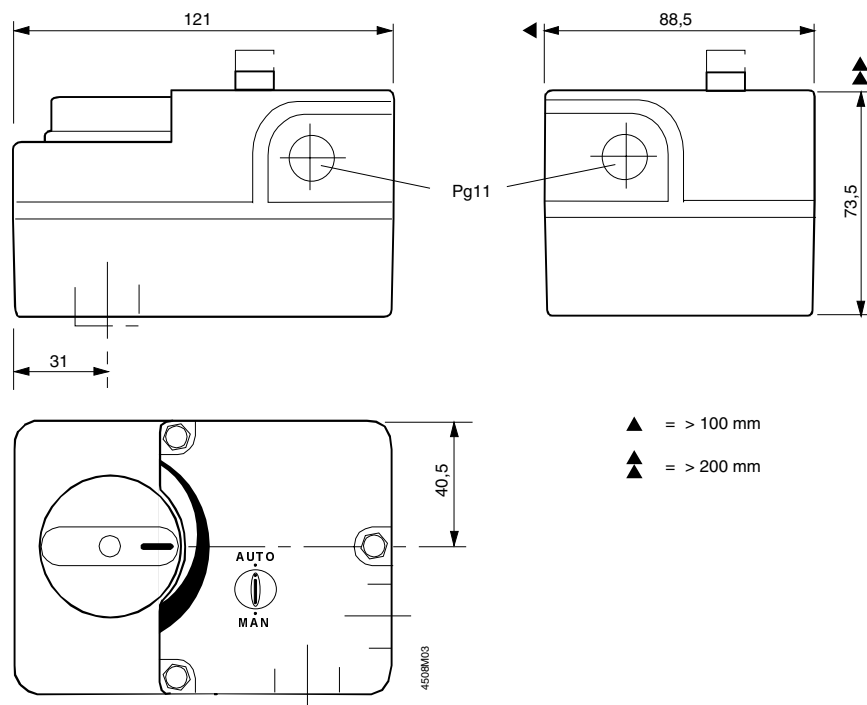

Total height of motorized valve:

- = connection dimension of slipper valve
- + connection dimensions of actuator
- + min. clearance to the ceiling or wall for installation, electrical connections and operation.