



GF2/GF3

2- and 3-way DIN-standard flanged valve

Control valves for use in heating, cooling and ventilation systems. They are intended to be used together with Regin's RVAN actuators. The valves have DIN-standard lengths.

- ✓ Size DN25...200
- ✓ Kvs value 6.3...550
- ✓ Rangeability 100:1 (DN50...200), > 50:1 (DN25...40)
- ✓ No leakage
- ✓ Pressure rating PN16
- ✓ Media temperature -5...+120°C
- ✓ Face-to-face dimensions as per DIN

Function

2-way valve

The valve is open when the stem is in its lowest position and closed when the stem is in its upmost position.

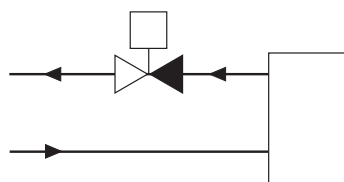

2-way valve

3-way valve

The 3-way valve is closed between port A and port AB (the ports opposite to one another) when the stem is in its highest position. In this position, the valve is also open between the bottom port B and the common supply port AB. When the stem is in its lowest position, the 3-way valve is completely open between port A and port AB and consequently closed between the bottom port B and the common port AB.

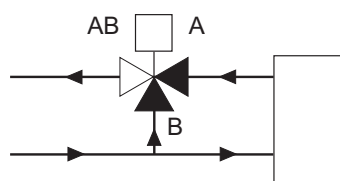

3-way valve

Installation

The 2-way valve should be mounted with port A on the inlet and port AB on the return (flow direction A in, AB out) to ensure that the plug closes tightly and to prevent any noise when closing.

The 3-way valve is of a mixing type and must therefore be mounted in the mixing point.

- Before installation of the control valve, ensure that the pipe is clean. Make sure that pipe scale, metal chips, welding slag and other foreign materials are removed.
- For maximum efficiency and minimum wear, install the valve in a vertical position with the stem pointing upward. If the valve is mounted with the actuator on the side, more wear is caused to the valve stuffing

box. The valve should never be mounted at an angle of more than 90°.

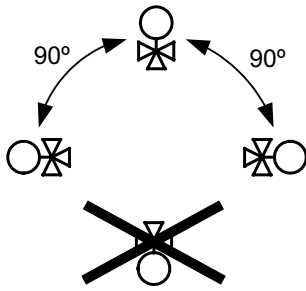

- Install the valve according to the fluid direction arrow shown on the valve.
- Make sure there is ample space above the valve to facilitate easy removal of the valve actuator.
- Adjust the connection between the valve and the counter flange to minimise the tension between them.
- Tighten the bolts crosswise, as shown in the picture below. Tighten one flange at a time. After conducting a test run, the bolts should be tightened crosswise once more.

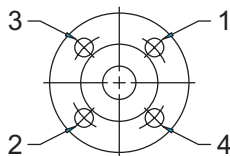

Fit a strainer/filter upstream of the valve to prolong the equipment's life span.

A water quality according to VDI 2035 is recommended.

Technical data

Application	Heating systems, cooling systems, ventilation systems
Pressure rating	PN16
Connection	Flanged according to EN 1092-2
Flow characteristics	A - AB = equal percentage, B - AB = linear
Max. leakage	0 % of Kvs
Media	Hot water, cold water, glycol-mixed water (max. 50 % glycol)
Media temperature	-5...+120 °C
Rangeability	100:1 (DN50...200), > 50:1 (DN25...40)

Material

Body	Cast iron Grade 250
Plug	Gunmetal 1400 LG2 (DN50...200), Brass CW614N (DN25...40)
Seat	Gunmetal 1400 LG2 (DN50...200), Cast iron Grade 250 (DN25...40)
Stem	Stainless steel 1.4305
Packing box	Brass CW614N
Bonnet	Brass CW614N
O-rings	EPDM
Packing	Aramid reinforced rubber

2-way valves

Article	Kvs	Nominal diameter
GF225-6.3	6.3	DN25
GF225-10	10	DN25
GF232-10	10	DN32
GF232-16	16	DN32
GF240-16	16	DN40
GF240-25	25	DN40
GF250-31.5	31.5	DN50
GF250-40	40	DN50
GF265-50	50	DN65
GF265-63	63	DN65
GF280-80	80	DN80
GF280-100	100	DN80
GF2100-125	125	DN100
GF2100-160	160	DN100
GF2125-215	215	DN125
GF2150-310	310	DN150
GF2200-550	550	DN200

Combination options (valves and actuators) and differential pressure

Type	ΔP_s (RVAN5...)	ΔP_{max} (RVAN5...)	ΔP_s (RVAN10...)	ΔP_{max} (RVAN10...)	ΔP_s (RVAN18...)	ΔP_{max} (RVAN18...)	ΔP_s (RVAN25...)	ΔP_{max} (RVAN25...)
GF225-6.3	700 kPa	400 kPa	1300 kPa	400 kPa	N/A	N/A	N/A	N/A
GF225-10	700 kPa	400 kPa	1300 kPa	400 kPa	N/A	N/A	N/A	N/A
GF232-10	450 kPa	350 kPa	800 kPa	350 kPa	N/A	N/A	N/A	N/A
GF232-16	450 kPa	350 kPa	800 kPa	350 kPa	N/A	N/A	N/A	N/A
GF240-16	300 kPa	300 kPa	550 kPa	300 kPa	N/A	N/A	N/A	N/A
GF240-25	300 kPa	300 kPa	550 kPa	300 kPa	N/A	N/A	N/A	N/A
GF250-31.5	200 kPa*	200 kPa*	350 kPa*	350 kPa*	700 kPa	450 kPa	1000 kPa	450 kPa
GF250-40	200 kPa*	200 kPa*	350 kPa*	350 kPa*	700 kPa	450 kPa	1000 kPa	450 kPa
GF265-50	100 kPa*	100 kPa*	200 kPa*	200 kPa*	350 kPa	350 kPa	700 kPa	400 kPa
GF265-63	100 kPa*	100 kPa*	200 kPa*	200 kPa*	350 kPa	350 kPa	700 kPa	400 kPa
GF280-80	N/A	N/A	N/A	N/A	300 kPa	300 kPa	400 kPa	350 kPa
GF280-100	N/A	N/A	N/A	N/A	300 kPa	300 kPa	400 kPa	350 kPa
GF2100-125	N/A	N/A	N/A	N/A	200 kPa	200 kPa	250 kPa	200 kPa
GF2100-160	N/A	N/A	N/A	N/A	200 kPa	200 kPa	250 kPa	200 kPa
GF2125-215	N/A	N/A	N/A	N/A	100 kPa	100 kPa	150 kPa	120 kPa
GF2150-310	N/A	N/A	N/A	N/A	80 kPa	80 kPa	120 kPa	100 kPa
GF2200-550	N/A	N/A	N/A	N/A	150 kPa	150 kPa	200 kPa	200 kPa

*The washer 02133005 is required in order to use the RVAN5... or RVAN10... actuators together with the DN50 or DN65 valves. The washer must be ordered separately.

ΔP_s constitutes the max. permitted differential pressure at which the valve actuator can safely close against the pressure.

ΔP_{max} constitutes the max. permitted differential pressure over the flow path of the valve for the entire actuating range of the actuator (i.e. open valve).

GF2200-550 has a balanced plug in order to achieve a higher max. differential pressure.

If larger actuating force than 2500 N is needed for DN125...DN200, please contact Regin.

3-way valves

Article	Nominal diameter	Kvs
GF325-6.3	DN25	6.3
GF325-10	DN25	10
GF332-10	DN32	10
GF332-16	DN32	16
GF340-16	DN40	16
GF340-25	DN40	25
GF350-31.5	DN50	31.5
GF350-40	DN50	40
GF365-50	DN65	50
GF365-63	DN65	63
GF380-80	DN80	80
GF380-100	DN80	100
GF3100-125	DN100	125
GF3100-160	DN100	160
GF3125-215	DN125	215
GF3150-310	DN150	310
GF3200-550	DN200	550

Combination options (valves and actuators) and differential pressure

Type	ΔP_s (RVAN5...)	ΔP_{max} (RVAN5...)	ΔP_s (RVAN10...)	ΔP_{max} (RVAN10...)	ΔP_s (RVAN18...)	ΔP_{max} (RVAN18...)	ΔP_s (RVAN25...)	ΔP_{max} (RVAN25...)
GF325-6.3	700 kPa	400 kPa	1300 kPa	400 kPa	N/A	N/A	N/A	N/A
GF325-10	700 kPa	400 kPa	1300 kPa	400 kPa	N/A	N/A	N/A	N/A
GF332-10	450 kPa	350 kPa	800 kPa	350 kPa	N/A	N/A	N/A	N/A
GF332-16	450 kPa	350 kPa	800 kPa	350 kPa	N/A	N/A	N/A	N/A
GF340-16	300 kPa	300 kPa	550 kPa	300 kPa	N/A	N/A	N/A	N/A
GF340-25	300 kPa	300 kPa	550 kPa	300 kPa	N/A	N/A	N/A	N/A
GF350-31.5	200 kPa*	200 kPa*	350 kPa*	350 kPa*	700 kPa	450 kPa	1000 kPa	450 kPa
GF350-40	200 kPa*	200 kPa*	350 kPa*	350 kPa*	700 kPa	450 kPa	1000 kPa	450 kPa
GF365-50	100 kPa*	100 kPa*	200 kPa*	200 kPa*	350 kPa	350 kPa	700 kPa	400 kPa
GF365-63	100 kPa*	100 kPa*	200 kPa*	200 kPa*	350 kPa	350 kPa	700 kPa	400 kPa
GF380-80	N/A	N/A	N/A	N/A	300 kPa	300 kPa	400 kPa	350 kPa
GF380-100	N/A	N/A	N/A	N/A	300 kPa	300 kPa	400 kPa	350 kPa
GF3100-125	N/A	N/A	N/A	N/A	200 kPa	200 kPa	250 kPa	200 kPa
GF3100-160	N/A	N/A	N/A	N/A	200 kPa	200 kPa	250 kPa	200 kPa
GF3125-215	N/A	N/A	N/A	N/A	100 kPa	100 kPa	150 kPa	120 kPa
GF3150-310	N/A	N/A	N/A	N/A	80 kPa	80 kPa	120 kPa	100 kPa
GF3200-550	N/A	N/A	N/A	N/A	50 kPa	50 kPa	70 kPa	70 kPa

*The washer 02133005 is required in order to use the RVAN5... or RVAN10... actuators together with the DN50 or DN65 valves. The washer must be ordered separately.

ΔP_s constitutes the max. permitted differential pressure at which the valve actuator can safely close against the pressure.

ΔP_{max} constitutes the max. permitted differential pressure over the flow path of the valve for the entire actuating range of the actuator (i.e. open valve).

If larger actuating force than 2500 N is needed for DN125...DN200, please contact Regin.

Dimensions

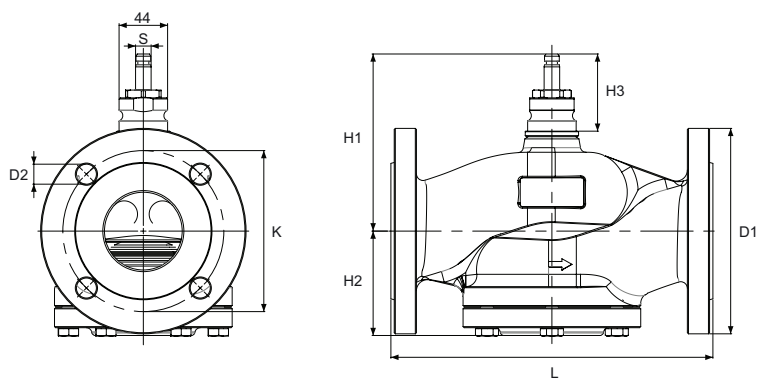

Type	DN	L	H1	H2	H3 ¹	Stroke ²	ØD1	ØD2	ØK	ØS
GF225-6.3	25	160	125	106	70	20	115	14 (x4)	85	10
GF225-10	25	160	125	106	70	20	115	14 (x4)	85	10
GF232-10	32	180	130	118	70	20	140	18 (x4)	100	10
GF232-16	32	180	130	118	70	20	140	18 (x4)	100	10
GF240-16	40	200	135	130	70	20	150	18 (x4)	110	10
GF240-25	40	200	135	130	70	20	150	18 (x4)	110	10
GF250-31.5	50	230	155	71	70	20	165	18 (x4)	125	14
GF250-40	50	230	155	71	70	20	165	18 (x4)	125	14
GF265-50	65	290	160	94	70	20	185	18 (x4)	145	14
GF265-63	65	290	160	94	70	20	185	18 (x4)	145	14
GF280-80	80	310	168	94	70	40	200	18 (x8)	160	14
GF280-100	80	310	168	94	70	40	200	18 (x8)	160	14
GF2100-125	100	350	179	134	70	40	220	18 (x8)	180	14
GF2100-160	100	350	179	134	70	40	220	18 (x8)	180	14
GF2125-215	125	400	180	147	70	40	250	18 (x8)	210	14
GF2150-310	150	480	205	155	70	40	285	22 (x8)	240	14
GF2200-550	200	600	255	176	70	40	340	22 (x12)	295	14

¹ Stem at depressed position

² $H3_{max} - H3_{min} = \text{stroke}$

Measurements in mm unless otherwise specified.

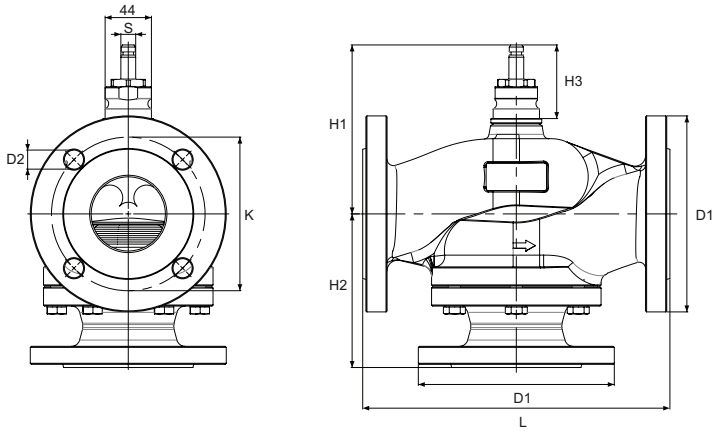

Type	DN	L	H1	H2	H3 ¹	Stroke ²	ØD1	ØD2	ØK	ØS
GF325-6.3	25	160	125	106	70	20	115	14 (x4)	85	10
GF325-10	25	160	125	106	70	20	115	14 (x4)	85	10
GF332-10	32	180	130	118	70	20	140	18 (x4)	100	10
GF332-16	32	180	130	118	70	20	140	18 (x4)	100	10
GF340-16	40	200	135	130	70	20	150	18 (x4)	110	10
GF340-25	40	200	135	130	70	20	150	18 (x4)	110	10
GF350-31.5	50	230	155	115	70	20	165	18 (x4)	125	14
GF350-40	50	230	155	115	70	20	165	18 (x4)	125	14
GF365-50	65	290	160	145	70	20	185	18 (x4)	145	14
GF365-63	65	290	160	145	70	20	185	18 (x4)	145	14
GF380-80	80	310	168	155	70	40	200	18 (x8)	160	14
GF380-100	80	310	168	155	70	40	200	18 (x8)	160	14
GF3100-125	100	350	179	175	70	40	220	18 (x8)	180	14
GF3100-160	100	350	179	175	70	40	220	18 (x8)	180	14
GF3125-215	125	400	180	200	70	40	250	18 (x8)	210	14
GF3150-310	150	480	205	240	70	40	285	22 (x8)	240	14
GF3200-550	200	600	255	300	70	40	340	22 (x12)	295	14

¹ Stem at depressed position

² $H3_{max} - H3_{min} = \text{stroke}$

Measurements in mm unless otherwise specified.

Pressure drop curves

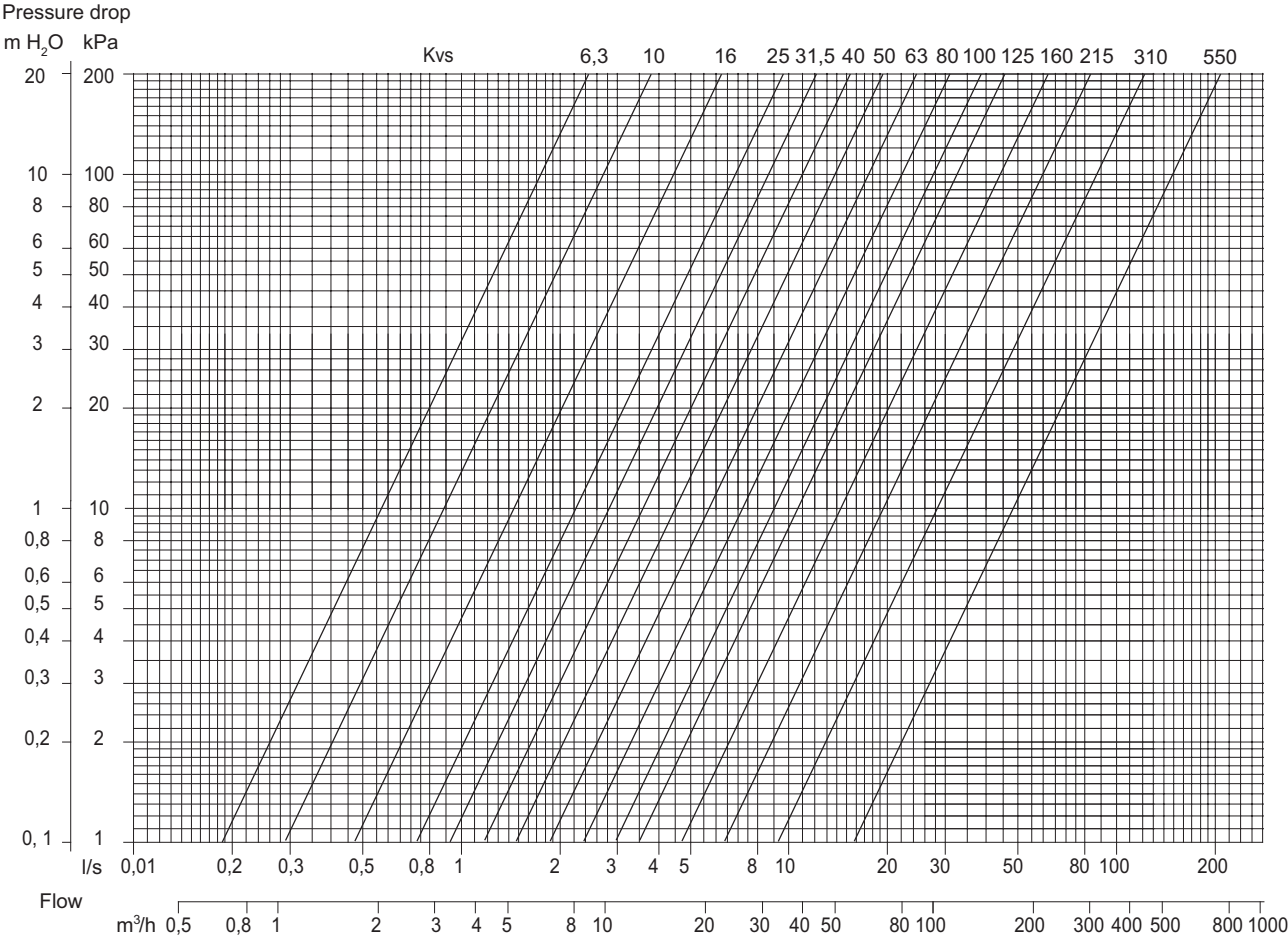

Example, pressure drop curves
If the pressure drop is 40 kPa (A) and the flow is 40 m³/h (B), a valve with the kv value 63 (C) is preferably selected. See the markings in the picture to the right.

