

Sinteso™ S-LINE

## Multisensor fire detectors

FDOOT241-A3, FDOOT241-A4, FDOOT241-A5, FDOOT241-A9, FDOOT241-8



### Multi-sensor fire detector for gradual modernization with ASAtechnology™

- For the modernization of collective/GMT/SynoLINE300, AlgoRex AnalogPLUS, and Interactive, SIGMALOOP, or MS8 on Sinteso FDnet
- Signal processing with ASAtechnology (Advanced Signal Analysis)
- Event-controlled detection behavior
- Early and reliable detection when fires occur
- Highly developed immunity to deceptive phenomena
- Maximum system availability thanks to sensory with redundancy
- Suitable for wind speeds of 1...20 m/s
- Ecological materials concept

### Ecological benefits

- Environmentally friendly processing
- Reusable materials
- Electronic parts and synthetic materials can be easily separated
- Environmentally friendly detector-testing without gas

### Features

- Resistant to environmental and interfering influences such as dust, fibers, insects, moisture, extreme temperatures, electromagnetic interference, corrosive vapors, vibration, artificial aerosols, and atypical fire phenomena
- Shock resistant, theft protection as an accessory
- Signal processing with ASA technology (Advanced Signal Analysis)
- Time and process-dependent detection behavior
- Proven immunity to faults in power electronics
- Protected electronics, high-quality components
- Sophisticated sensors and electronic monitoring
- Redundant, high-quality sensor system
- Internal alarm indicator (IAI), 360° visibility, alignment not necessary
- Integrated line separator

## Multi-sensor fire detector FDOOT241-A3, FDOOT241-A4, FDOOT241-A5, FDOOT241-A9, FDOOT241-8

**Multi-sensor fire detector consisting of:**

- Point detector with additional heat sensors
- Detector dust cap to protect the point detector during the construction phase

**Function**

- Functions according to the scattered light principle with two sensors, optical forward and backward scattering
- Opto-electronic measuring chamber, obstructs disruptive extraneous light but can be relied upon to detect both light and dark smoke particles
- Two additional heat sensors increase the fire detector's immunity to deceptive phenomena
- Can be set as a multi-sensor smoke detector, smoke detector, or heat detector by the software
- Selectable detection behavior thanks to application-specific ASA parameter sets
- Multi-protocol:
  - FDOOT241-A3 (AlgoRex AnalogPLUS, FDnet)
  - FDOOT241-A4 (SIGMALOOP, FDnet)
  - FDOOT241-A5 (AlgoRex Interactive, FDnet)
  - FDOOT241-A9: Collective / GMT (Cerberus / Siemens) / SynoLINE300, FDnet
  - FDOOT241-8 (MS8/PMT, FDnet)

**Use**

- For early detection of flaming fires of solid and liquid substances as well as of smoldering fires
- For early and reliable fire detection in an environment with deceptive phenomena
- Can be used addressed, for the gradual modernization of:
  - AlgoRex AnalogPLUS on Sinteso FDnet <sup>1</sup> with FDOOT241-A3
  - SIGMALOOP on Sinteso FDnet <sup>1</sup> with FDOOT241-A4
  - AlgoRex Interactive on Sinteso FDnet <sup>1</sup> with FDOOT241-A5
  - Collective/GMT/SynoLINE300 on Sinteso FDnet <sup>1</sup> with FDOOT241-A9
  - MS8/PMT on Sinteso FDnet with FDOOT241-8

<sup>1</sup> FS20 compatibility in FDnet is assured subject to in-country FS20 software support.

## Type Overview

Type	Order number	Designation	Weight [kg]
<b>Point detector</b>			
FDOOT241-A3	S54310-F10-A1	Multi-sensor fire detector Sinteso (A+)	0.106
FDOOT241-A4	S54310-F9-A1	Multi-sensor fire detector Sinteso (SIGMA)	0.106
FDOOT241-A5	S54310-F14-A1	Multi-sensor fire detector Sinteso (Interactive)	0.106
FDOOT241-A9	S54310-F11-A1	Multi-sensor fire detector Sinteso ASA	0.106
FDOOT241-8	A5Q00004663	Multi-sensor smoke detector Sinteso ASA	0.106
<b>Migration kits</b>			
FDOOT241-8M	A5Q00016038	Migration kit (FDOOT241-8 + FDB281)	0.235
FDOOT241-8B	A5Q00015956	Migration kit (FDOOT241-8 + FDB221)	0.162
<b>Base adapter</b>			
FDB241	S54319-F13-A1	Base adapter Sinteso (SIGMA/A+)	0.086
FDB251	S54319-F28-A1	Base adapter Sinteso (Interactive)	0.090
FDB281	A5Q00004929	Base adapter MS8/PMT	0.125
FDB299	S54319-F14-A1	Base adapter Sinteso (AlgoRex coll.)	0.086
<b>Other accessories</b>			
FDUD290	S54370-S13-A1	Removal tool for adapter	0.098



You will find information about the color options for the fire detectors in the data sheet 009409.

## Accessories

### Base adapter FDB241



#### Function:

- For adapting AnalogPLUS and SIGMALOOP for Sinteso detector systems
- Can be set with jumper on replaced detector

### Base adapter FDB251



#### Function:

- For adapting Interactive for Sinteso detector systems
- Can be set with jumper on replaced detector

### Base adapter FDB281

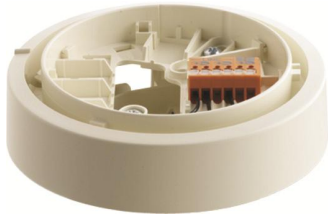

**Function:**

- For adapting MS8/PMT for Sinteso detector systems

### Base adapter FDB299



**Function:**

- For adapting AlgoRex (collective) and SIGMACON for Sinteso detector systems

### Removal tool for adapter FDUD290



**Function:**

- For removing base adapters FDB2xx with detector exchanger, detector exchanger and tester, or detector tester

## Notes

### Efficiency on-site

- No wiring, detector replacement only
- Detectors can be replaced without a ladder at heights up to 8 m with the detector exchanger FDUD291, detector exchanger and tester FDUD292, or intelligent detector tester FDUD293 in combination with telescope or extension rod.

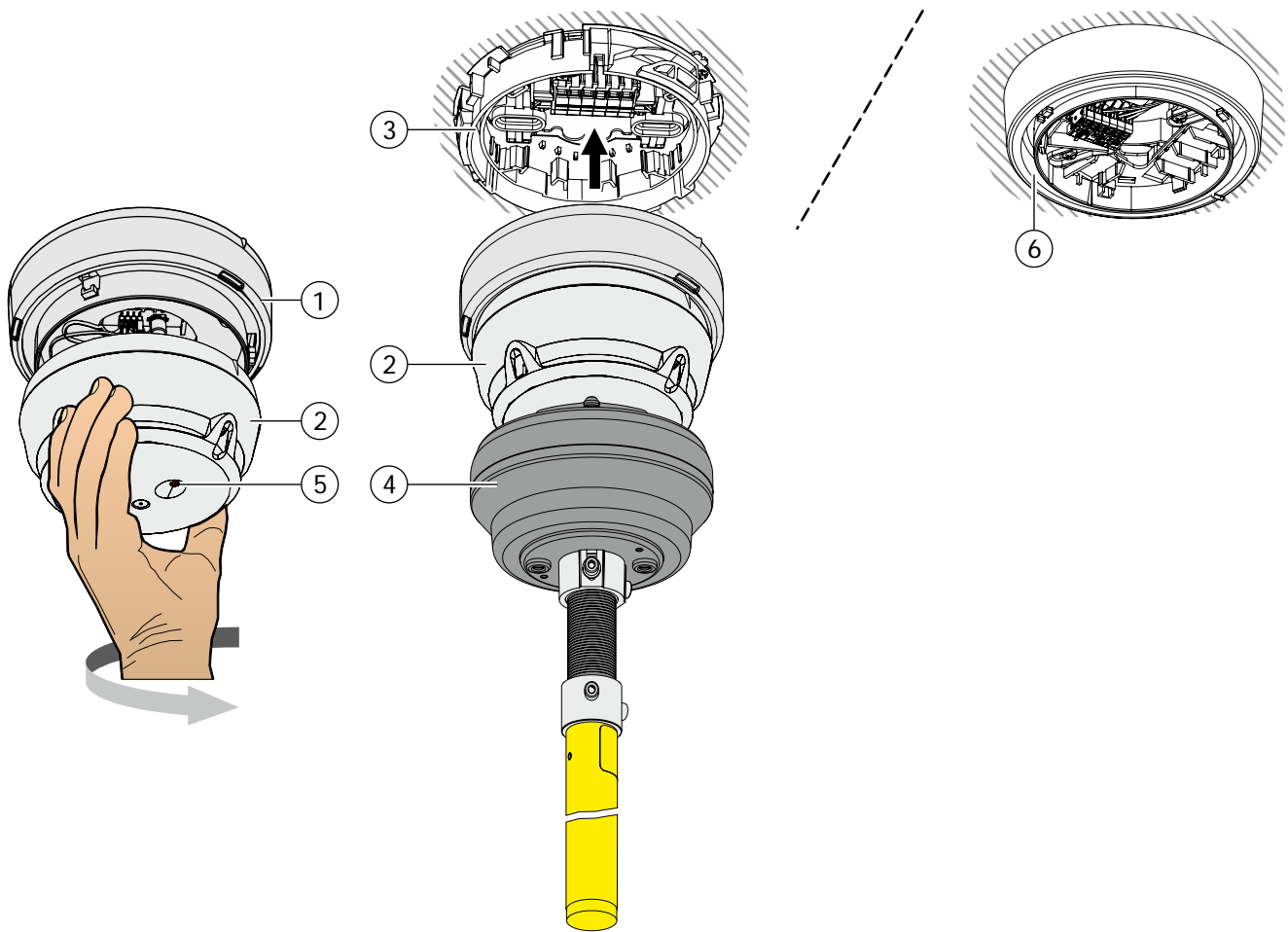

① Base adapter	② Point detector	③ Detector base	④ Detector exchanger/detector exchanger and tester	⑤ IAI
FDB241	FDOOT241-A3	AnalogPLUS (DB1131)	FDUD291 FDUD292 FDUD293	Internal alarm indicator
	FDOOT241-A4	SIGMALOOP (SPF3600)		
FDB251	FDOOT241-A5	Interactive (DB1151A)		
FDB299	FDOOT241-A9	AlgoRex collective (DB1101A)/ SIGMACON (SPF600)		
FDB281	FDOOT241-8	⑥ MS8 (Z84)		

1. Screw the point detector into the base adapter.
2. Screw the point detector with the attached base adapter into the detector base by hand or with a detector exchanger or detector exchanger and tester.
  - a The point detector is mounted.

## Technical data

	FDOOT241-A3	FDOOT241-A4	FDOOT241-A5	FDOOT241-A9	FDOOT241-8	FDOOT241-A3, FDOOT241-A4, FDOOT241-A5, FDOOT241-A9, FDOOT241-8
	In the AnalogPLUS detector system	In the SIGMALOOP detector system	In the Interactive detector system	In the collective detector system	In the MS8 detector system	In FDnet
Operating voltage (modulated)	DC 16...28 V	DC 10...28 V	DC 21...33 V	DC 14...28 V	DC 14...28 V	DC 12...33 V
Operating current (quiescent)	190 µA	200 µA	200 µA	65...125 µA	200 µA	190...230 µA
External alarm indicators (AI) which can be connected	2	2	2	2	2	2
Communication protocol	AnalogPLUS	SIGMALOOP	Interactive	Collective	MS8/PMT	FDnet
System compatibility	AlgoRex	SIGMASYS	AlgoRex	AlgoRex, SIGMASYS, CZ10	SIGMASYS, BMS, SM80/88/D100, SRS	FS20 <sup>1</sup>
Operating temperature	-25...+70°C	-25...+70°C	-25...+70°C	-35...+70°C	-25...+70°C	-
Storage temperature	-30...+75°C	-30...+75°C	-30...+75°C	-35...+75°C	-30...+75°C	-
Humidity	≤95 % rel.					
Color	~RAL 9010 pure white					
Protection category (IEC 60529) with detector base FDB221, FDB222	IP43					
Base attachment FDB291	IP44					
Base adapter FDB281	IP44					
Base adapter FDB241 and detector base DB1131A, or SPF3600	IP44					
Base adapter FDB251 and detector base DB1151A	IP44					
Base adapter FDB299 and collective detector base DB1101A or SPF600	IP44					

	FDOOT241-A3	FDOOT241-A4	FDOOT241-A5	FDOOT241-A9	FDOOT241-8	FDOOT241-A3, FDOOT241-A4, FDOOT241-A5, FDOOT241-A9, FDOOT241-8
Standards	CEA 4021, EN 54-5, EN 54-7, EN 54-17, EN 54-27 <sup>2</sup>					
Approvals						
VdS	G211125	G212007	G215057	G212036	G204133	-
LPCB	126bh/02	-	126bh/07	126bh/03	-	-
DNV GL (marine)	-	-	-	45 246 – 16 HH	-	-
Permissible wind speed	1...20 m/s					

<sup>1</sup> FS20 compatibility in FDnet is assured subject to in-country FS20 software support.

<sup>2</sup> EN 54-27 for FDOOT241-A3, FDOOT241-A4, FDOOT241-A9 only

## Dimensional drawing

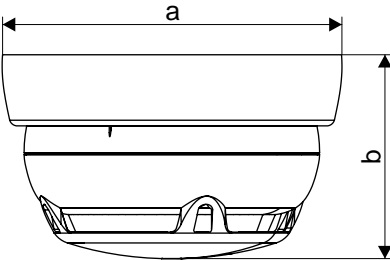
Combination			
	Dimension 'a'	Dimension 'b' with detector base	Dimension 'b' without detector base
Detector base AnalogPLUS (DB1131A) Base adapter FDB241 Multi-sensor fire detector FDOOT241-A3	117	77.9	73.3
Detector base AnalogPLUS (SPF3600) Base adapter FDB241 Multi-sensor fire detector FDOOT241-A4			
Detector base Collective (DB1101A or SPF600) Base adapter FDB299 Multi-sensor fire detector FDOOT241-A9			
Detector base Interactive (DB1151A) Base adapter FDB251 Multi-sensor fire detector FDOOT241-A5			
Detector base MS8 Base adapter FDB281 Multi-sensor smoke detector FDOOT241-8		91.4	73.5





## Applicable documents

Document ID	Title
007004	Technical manual Automatic fire detectors FDOOT221, FDOOT241-A3, FDOOT241-A4, FDOOT241-A5, FDOOT241-8, FDOOT241-9, FDOOT241-A9, FDO241, FDO221, FDT241, FDT221
008116	Installation Base adapter FDB281
008164	Equipment overview Sinteso™ Detector system FD20
008331	List of compatibility (for 'Sinteso™' product line)
009409	Data sheet Colored detectors, bases and base attachment FDO., FDOOT..., FDT..., FDB...
A6V10301448	Installation Base adapter FDB299
A6V10301452	Installation Base adapter FDB241
A6V10323158	Technical manual Modernizing fire detection installations with multiple protocol detectors
A6V10411361	Installation Base adapter FDB251

11	 0786	<b>FDOOT241-A3</b>	Siemens Switzerland Ltd, Gubelstrasse 22 CH-6301 Zug Technical data: see doc. <b>007004</b>
FDOOT241-A3 - Smoke/heat detector incl. short-circuit isolator for use in fire detection and fire alarm systems installed in buildings.			
305/2011/EU (CPR): EN 54-5 / EN 54-7 / EN 54-17; 2014/30/EU (EMC): EN 50130-4 / EN 61000-6-3 ; 2011/65/EU (RoHS): EN 50581			
The declared performance and conformity can be seen in the Declaration of Performance (DoP) and the EU Declaration of Conformity (DoC), which is obtainable via the Customer Support center: Tel. +49 89 9221-8000 or <a href="http://siemens.com/bt/download">http://siemens.com/bt/download</a>			
DoP No.: 0786-CPR-21128; DoC No.: CED-FDOOT241-A3			

12	 0786	<b>FDOOT241-A4</b>	Siemens Switzerland Ltd, Gubelstrasse 22 CH-6301 Zug Technical data: see doc. <b>007004</b>
FDOOT241-A4 - Smoke/heat detector incl. short-circuit isolator for use in fire detection and fire alarm systems installed in buildings.			
305/2011/EU (CPR): EN 54-5 / EN 54-7 / EN 54-17; 2014/30/EU (EMC): EN 50130-4 / EN 61000-6-3 ; 2011/65/EU (RoHS): EN 50581			
The declared performance and conformity can be seen in the Declaration of Performance (DoP) and the EU Declaration of Conformity (DoC), which is obtainable via the Customer Support center: Tel. +49 89 9221-8000 or <a href="http://siemens.com/bt/download">http://siemens.com/bt/download</a>			
DoP No.: 0786-CPR-21138; DoC No.: CED-FDOOT241-A4			

15	 0832	<b>FDOOT241-A5</b>	Siemens Switzerland Ltd, Gubelstrasse 22 CH-6301 Zug Technical data: see doc. <b>007004</b>
FDOOT241-A5 - Smoke/heat detector incl. short-circuit isolator for use in fire detection and fire alarm systems installed in buildings.			
305/2011/EU (CPR): EN 54-5 / EN 54-7 / EN 54-17; 2014/30/EU (EMC): EN 50130-4 / EN 61000-6-3 ; 2011/65/EU (RoHS): EN 50581			
The declared performance and conformity can be seen in the Declaration of Performance (DoP) and the EU Declaration of Conformity (DoC), which is obtainable via the Customer Support center: Tel. +49 89 9221-8000 or <a href="http://siemens.com/bt/download">http://siemens.com/bt/download</a>			
DoP No.: 0832-CPR-F0893; DoC No.: CED-FDOOT241-A5			

12	 0786	<b>FDOOT241-A9</b>	Siemens Switzerland Ltd, Gubelstrasse 22 CH-6301 Zug Technical data: see doc. <b>007004</b>
FDOOT241-A9 - Smoke/heat detector incl. short-circuit isolator for use in fire detection and fire alarm systems installed in buildings.			
305/2011/EU (CPR): EN 54-5 / EN 54-7 / EN 54-17; 2014/30/EU (EMC): EN 50130-4 / EN 61000-6-3 ; 2011/65/EU (RoHS): EN 50581			
The declared performance and conformity can be seen in the Declaration of Performance (DoP) and the EU Declaration of Conformity (DoC), which is obtainable via the Customer Support center: Tel. +49 89 9221-8000 or <a href="http://siemens.com/bt/download">http://siemens.com/bt/download</a>			
DoP No.: 0786-CPR-21155; DoC No.: CED-FDOOT241-A9			

07	 0786	<b>FDOOT241-8</b>	Siemens Switzerland Ltd, Gubelstrasse 22 CH-6301 Zug Technical data: see doc. <b>007004</b>
FDOOT241-8 - Smoke/heat detector incl. short-circuit isolator for use in fire detection and fire alarm systems installed in buildings.			
305/2011/EU (CPR): EN 54-5 / EN 54-7 / EN 54-17; 2014/30/EU (EMC): EN 50130-4 / EN 61000-6-3 ; 2011/65/EU (RoHS): EN 50581			
The declared performance and conformity can be seen in the Declaration of Performance (DoP) and the EU Declaration of Conformity (DoC), which is obtainable via the Customer Support center: Tel. +49 89 9221-8000 or <a href="http://siemens.com/bt/download">http://siemens.com/bt/download</a>			
DoP No.: 0786-CPR-20008; DoC No.: CED-FDOOT241-8			

Issued by  
Siemens Switzerland Ltd  
Building Technologies Division  
International Headquarters  
Gubelstrasse 22  
CH-6301 Zug  
Tel. +41 41-724 24 24  
[www.siemens.com/buildingtechnologies](http://www.siemens.com/buildingtechnologies)

© Siemens Switzerland Ltd, 2012  
Technical specifications and availability subject to change without notice.