



Design™ TRA

Freely configurable flush-mounted room operator unit for KNX PL-Link

QMX3.P36F
QMX3.P36G

For use in with PXC3... series room automation stations

- Freely configurable user interface (keys and visual items) as part of Total Room Automation
- Energy efficiency function ("Green Leaf )
- Room temperature measurement
- Display of room temperature, control mode, scenes etc. (LCD)
- Backlit display, white or blue selection
- KNX PL-Link interface to the room automation station with plug & play functionality
- Can be combined with different standard and design bezels

Use

The QMX3.P36... room operator unit is used as part of Desigo room automation to measure the room temperature as well as to operate the room functions. The room automation station determines the functions of both LCD display and keys.

The room operator unit can be used together with the PXC3... series room automation stations.

Type summary, ordering

	Product number	Stock number	Designation
Room operator units	QMX3.P36F	S55624-H100	Freely configurable flush-mounted room operator unit for KNX PL-Link with square white bezel CEE/VDE (type A)
	QMX3.P36G	S55624-H101	Freely configurable flush-mounted room operator unit for KNX PL-Link with landscape white bezel (3 modules landscape)

The following items are supplied in the package:

Item	QMX3.P36F	QMX3.P36G	
Operator unit	X	X	
Bezel, titanium white	Siemens DELTA-line	Similar to Delta azio 120 x 80 mm	
Base plate	CEE/VDE (type A)	3 modules landscape	} In plastic bag for handover to electrical installer
KNX PL-Link plug	X	X	

Compatibility

- The QMX3.P36... room operator unit can be used with all PXC3 series room automation stations.
- Supported bezel programs
Siemens DELTA: DELTA line, DELTA miro and DELTA vita.
(For the DELTA style and DELTA profil series an adapter frame for 55mm x 55mm inserts is required)
Berker:(B.1, B.7
Gira: Standard 55, E2, Event, Esprit
Jung: A500, AS500, stainless steel; LS990, aluminum
Merten: System M
Feller: EDIZIOdue, PRESTIGE
(Adapter frame for 55mm x 55mm devices is required)
- Bezels from various other manufacturers can also be used (*suitability must be clarified in advance*).

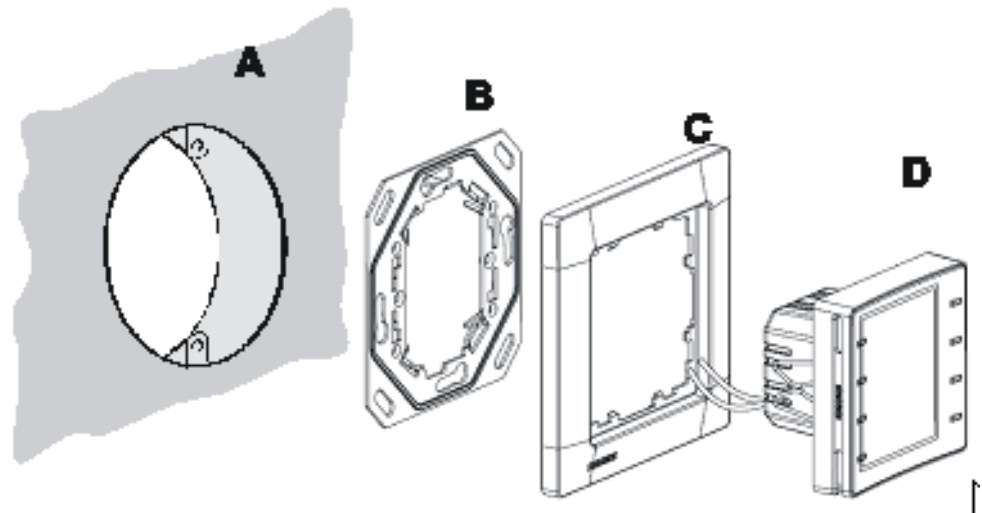

- The unit is designed for mounting in a **conduit box (A)**
 - **Square** CEE/VDE (type A)
 - **Rectangular** 3 modules landscape (suitability to be clarified in advance).
- The **base plate (B)** (rectangular or landscape) contains:
 - A hook to attach a securing strap to protect against tampering (the strap is not provided)
 - an earthing plate (quick slide connector) to connect an earthing cable
- One **Bezel (C)** is supplied:
 - Siemens DELTA line (**square**, with the QMX3.P36F)
 - Siemens similar to DELTA azio 120 x 180 (**rectangular**, with the QMX3.P36G)Bezels from various other manufacturers can also be used (suitability to be clarified in advance).
- The **operator unit (D)** incorporates the room temperature sensor element, keys, LCD panel, KNX PL-Link plug, tool plug, and spring clamps to hold the operator unit in the base plate.

Disposal



The device is considered an electronics device for disposal in terms of European Directive 2012/19/EU and may not be disposed of as domestic garbage.

- Dispose of the device through channels provided for this purpose.
- Comply with all local and currently applicable laws and regulations.

- The room operator units offer plug & play functionality.
- The room operator units receive their power from the connected room automation station via the KNX PL-Link interface.
- KNX PL-Link supports plug & play functionality for pre-configured devices out of the library
- For KNX PL-Link wiring (topology, allowed cables and cable length), see the Desigo installation guide, CM111043.
- Normally, electrical installers only install the base plate and the KNX PL-Link plug. These two items are packed in a plastic bag for easy handover to installers.
- Use the tear-off label with the barcode on the packaging / on the display and stick it on the floor plan to prepare commissioning for several room operator units per room automation station.
The same barcode label with unique identifier is available on the device.
Furthermore, the unique identifier (HEX number) is displayed on screen when starting the device.

Mounting and installation

Location

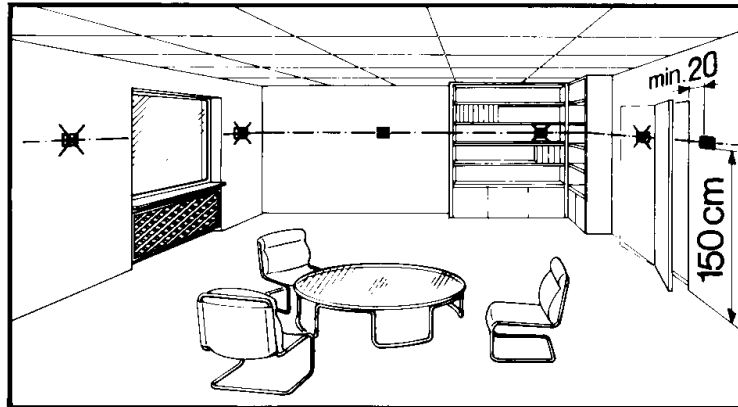

- The room operator unit is suitable for flush mounting.
- Recommended height: 1.50 m above floor.
- Do not mount the unit in recesses, shelves, behind curtains or doors, or above or near heat sources.
- Avoid direct solar radiation and drafts.
- Seal the conduit box internally, as air currents in the conduit can affect sensor readings.
- Adhere to allowed ambient conditions.

Mounting

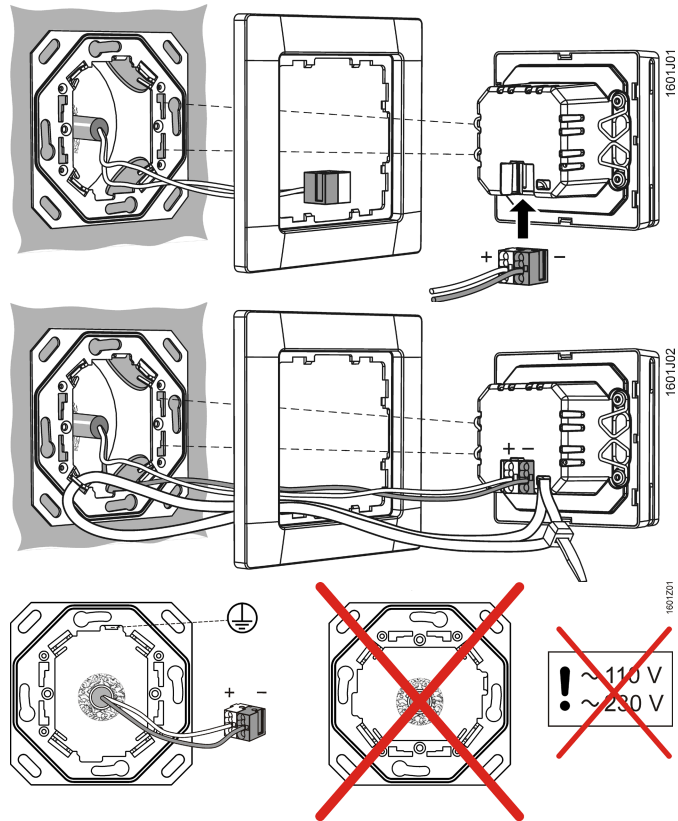

- The base plate contains:
 - A hook to attach a securing strap to protect against tampering (the strap is not provided)
 - An earthing plate (quick slide connector) to connect an earthing cable
- The installing tube must be sealed or cold or warm air may enter the conduit box and cause faulty temperature readings by the internal sensor.
- Mounting instructions are printed inside the device package and are also on the plastic bag.

Dismounting

The operator unit may need to be dismantled from the base plate to exchange the operator unit.

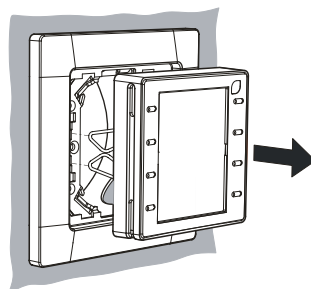

1. Hold bezel with one hand.
2. Pull operator unit with the other hand.

Installation

- For KNX PL-Link wiring (topology, allowed cables and cable length), see the Desigo TRA installation guide, CM111043.
- Use the correct cables for the KNX PL-Link bus
- Do not interchange the wires of the KNX PL-Link cable.
 - The red terminal is for KNX PL-Link +
 - The gray terminal is for KNX PL-Link –
- Observe all local installation regulations.
- Use the earthing plate (quick slide connector) to connect an earthing cable in the conduit box (in case a switch or a mains plug is in the same conduit box).
- **The unit is not protected against accidental connection to AC 230 V.**
- The installing tube must be sealed or cold or hot air may enter the conduit box and cause faulty temperature readings by the internal sensor.



Caution

Prerequisite for commissioning

The room automation station must be running and an application must be loaded.

Load application on the room automation station

The application is not loaded on the room operator unit, but the room automation station.
Download of the application is done using the SSA-DNT (Pack & Go) or the ABT. For this purpose (or for service), connect the ABT to the room automation station (USB or Ethernet).

Manual commissioning

All commissioning work is done via the PXC3... room automation station, using the SSA-DNT or the ABT.

The ABT is never connected directly to a room operator unit.

When more than one QXM3.P36... room operator unit is on the same trunk of the KNX PL-Link bus, manually commission is done as follows:

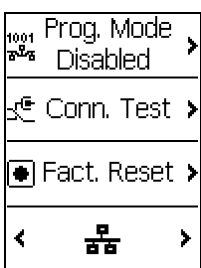

1. Connect the SSA-DNT or the ABT to the room automation station and activate the online commissioning function.
2. Load the web page "KNX PL-Link identification".
Activate the identification function.
The room automation station now waits for a signal from the room operator unit.
3. On the room operator unit, simultaneously press the upper left and bottom right button for at least 5 seconds.
4. The page "System info" is displayed.
Go to the network function page (last line)
5. Press "Prog. Mode" (first line).
The display below "Prog. Mode" changes to "Enabled".
The tool identifies the current room operator unit that is operated and assigns it.

After the device is commissioned, programming mode is automatically reset to "disabled". Note: Programming mode also resets to "disabled" each time the device restarts.

Diagnostics

Press "Conn. Test" to test the KNX PL-Link connection.
A popup window shows the progress of the connection test:

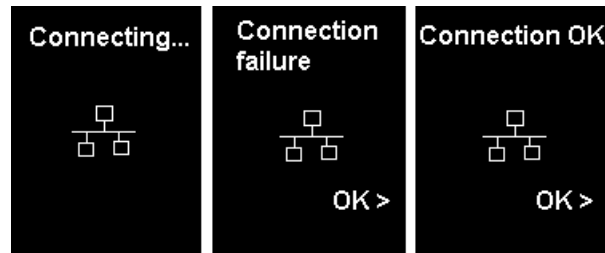

Reset to factory setting



Note! This operation resets all user preference data and configuration settings to factory default. This operation is irreversible.

Press "Fact. Reset". The device is locked and reboots within 10 seconds. The room automation station deletes it from its device list. During this time, it is safe to remove the device from the network.

If the room operator unit is not unplugged, it acts like a newly inserted device requiring again automated or manual configuration.

Commissioning (plug & play)

When only one room operator unit is connected to the KNX PL-Link bus, the unit automatically establishes communications with the room automation station, from where the functions are downloaded to the room operator unit (plug & play).

The following routine is executed:

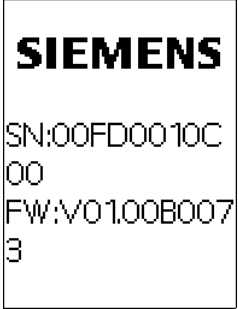
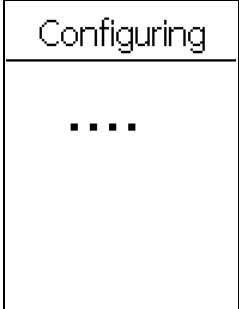
Step	Function	Description
1	Splash screen 	The unique serial number of the device is displayed below the company logo.
2	Busy 	<p>During configuration, 6 animated dots appear in the center of the screen to indicate the device is busy.</p> <p>This step is skipped if the device is already configured.</p> <p>Note: The configuration file can be downloaded any time; as a result, these dots are displayed every time the room automation station initializes download.</p>

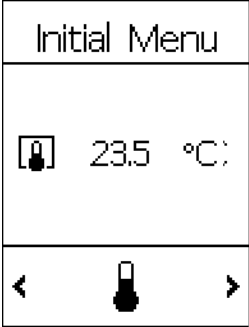
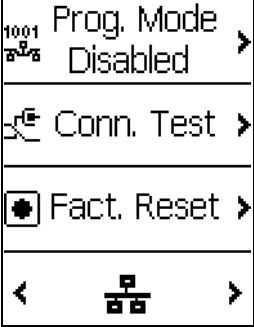
Step	Function	Description
3	Normal operation 	After startup, the device goes to normal operation (example view; picture depends on application in room automation station).
4	Configuration required  	When configuration is faulty, the default page "Initial Menu" is displayed: temperature that is measured by the local temperature sensor along with a menu for network commissioning and diagnostics.

Operating notes

Operation and display of the room operator unit depend on the control program on the room automation station.



Usability concept

The display has 4 lines to display information. Texts, icons, read-only data point information, or operable data point information can be displayed.

Multi-page display with navigation

With a multi-page navigation-driven page set, the information usually is laid out in the following format:

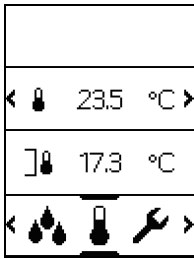
- Line 1 Title/read-only data point information
- Line 2 Information
Operable data point information (display or setpoint)
Temperature, air quality, fan speed, etc.
- Line 3 Read-only / operable data point information
- Line 4 Information or navigation between several "pages"

	Info Operable Read-only Navigation		Info Operable Navigation		Info Operable Navigation
---	---	---	--------------------------------	---	--------------------------------

3 lines of information

List operation

Single-line operation

Single-page display

With a single-page page set, information is usually laid out in the following format:



- Line 1 Title / read-only data point information
- Line 2 Operable data point information
Temperature, air quality, fan speed, etc.
- Line 3 Read-only/operable data point information
- Line 4 Read-only/operable data point information



Example:

Title (empty), temperature setpoint, fan speed and room operating mode

RoomOptiControl, Green Leaf

The leaf symbol  /  (green, red) at the top right of the device tells the user if the settings are energy-efficient or not.

Pressing the upper right key resets the application to energy-efficient parameter values

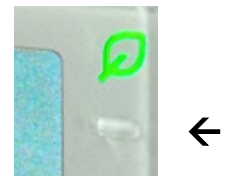

Saving scenes

Save a changed scene by long pressing the key (approx. 3 sec).

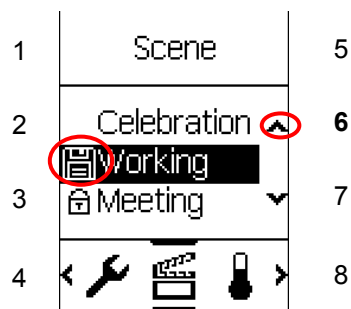

Notes

- A scene can only be saved if Scene Teaching is enabled in the application.
 - The key event to save a scene can be freely engineered.
- In the default page set, it is set to "long-press key 6" (the keys are numbered left top to bottom and then right top to bottom).

Key lock



- Lock the buttons:
Press button 6 6
- Unlock the buttons:
Press buttons 2, 3 and 7 one after the other

Status information

A list item provides status information:



- **Tick:** Indicates the current selection from the room automation station. A change from hourglass to tick indicates that the automation station has confirmed the modifications the user just made.
- **Hourglass:** Indicates the progress of the selected activity.
- **Lock:** Indicates locked entries that cannot be selected / enabled.
- **Floppy disk:** Is only used in scene saving, and will be displayed for 1 second, then go back to "Tick".

Maintenance





Note!

The device can be cleaned with off-the shelf, solvent-free cleaning agents. Do not use mechanical aids (rough sponge or similar materials) – only a soft, damp cloth.
Dismounting: see page 5.

Technical data

Supply voltage	Operating voltage range	KNX PL-Link DC 21...30 V
	The room operator unit receives its power from the connected room automation station via the KNX PL-Link interface	
Operating data	Power consumption (from room automation station)	Max. 10 mA at DC 24 V <i>Series A: Max. 12.5 mA at DC 24 V</i>
	Temperature sensor	
Display	Measuring element	NTC resistance sensor
	Measuring range	0...50 °C
	Measuring accuracy (5 ... 30 °C)	±0.61 K
	Measuring accuracy (25 °C)	±0.35 K
Ports/interfaces	Type	Dot matrix LCD, resolution 96 x 128
	Information displayed depends on the application in the PXC3... room automation station	– Room temperature – Setpoint adjustment – Control mode – Manually selected fan speed – Control sequence – Scenes – etc.
Housing protection	Type of port between room automation station and room operator unit	KNX PL-Link
	Baud rate	9.6 kbps
	Standard KNX plug	Wire diameter 0.8 mm, max. 1.0 mm (solid conductors only)
	Cable type	Solid conductors 2-core, twisted pair
	Single cable length (from room automation station to room operator unit)	<1000 m
Protection class	Cables must comply with KNX specifications, see TRA Installation manual, CM111043	
	Protection standard as per EN 60529	IP 30
	Insulation protection class	III

Ambient conditions	IEC 721	Normal operation	Transport
	Environmental conditions	Class 3K5?	Class 2K3?
	Temperature	0...50 °C	- 25...70 °C
	Humidity	< 85 % rh	< 95 % rh
	Mechanical conditions	Class 3M2	Class 2M2
Standards and directives	EU conformity (CE)	CM2T1602xx ^{*)}	
	 compliance	UL916	
	 compliance	Part 15 of the FCC rules	
	CSA compliance	C22.2 No 205 – Signal equipment C22.2 No 0 – General Requirements	
	 RCM Mark conformity (EMC)	AS/NZS 61000-6-3	
The product environmental declaration CM2E1601 ^{*)} contains data on environmentally compatible product design and assessments (RoHS compliance, materials composition, packaging, environmental benefit, disposal)			
Color	Front housing	Titanium white similar to RAL9010	
Weight		QMX3.P36F	QMX3.P36G
	Operator unit	50 g	50 g
	Bezel, base plate	32 g	63 g
	Packaging	44 g	54 g
	Total	126 g	167 g

*) The documents can be downloaded from <http://siemens.com/bt/download>.

Connection

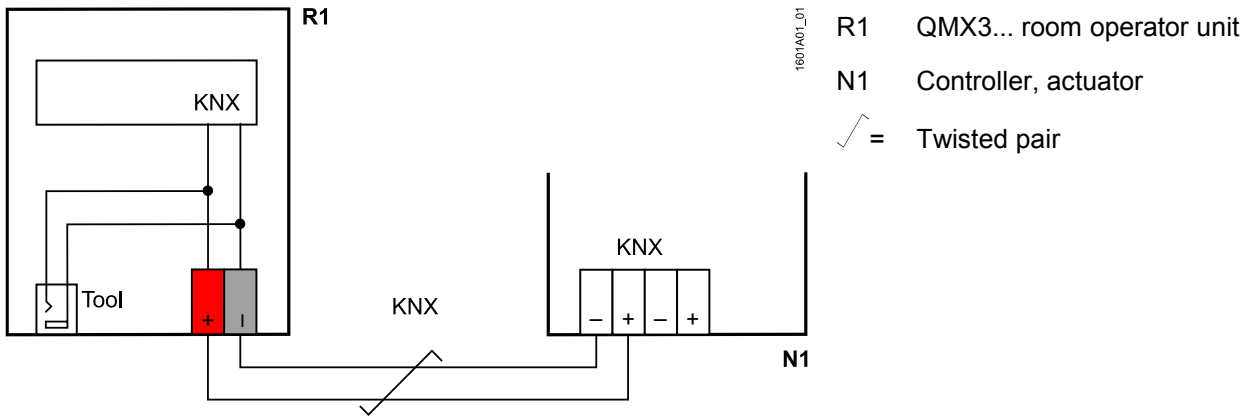

KNX / PL-Link plug

+	Red	KNX PL-Link (positive)
-	Gray	KNX PL-Link (negative)



Note!

Wires are NOT interchangeable!

The device is protected against faulty wiring, but communications does not work on interchanged wires.

Tool plug
(2.5 mm Jack)

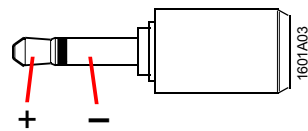

RJ45 plug of the tool cable

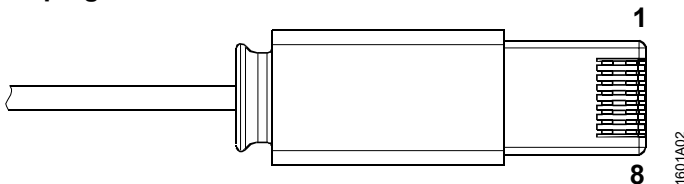

- | | | | |
|---|----------|---|--------------|
| 1 | CE+, KNX | 5 | Voltage 16 V |
| 2 | CE-, KNX | 6 | N.C. |
| 3 | N.C. | 7 | Ident'pin |
| 4 | N.C. | 8 | GND |

Connect the tool

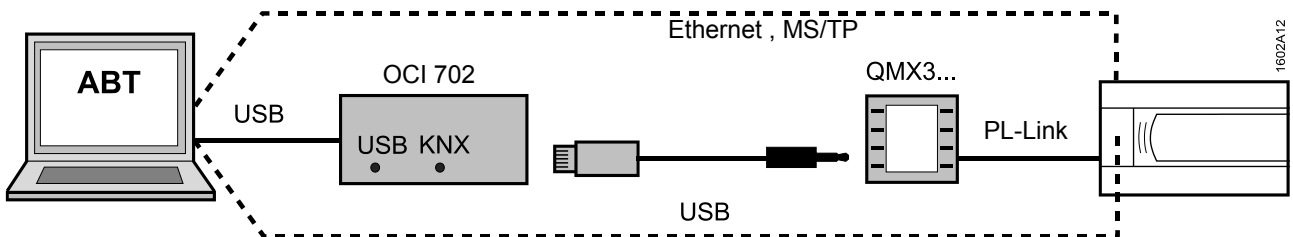

Connect the ABT to load the application in the room automation station, or for service purposes:

- Directly to the room automation station
- To the room unit using the tool cable and the OCI702 service interface (see data sheet A6V10438951)

Note: Remove the operator unit from the base plate to connect the tool cable.

Dimensions

Operator unit

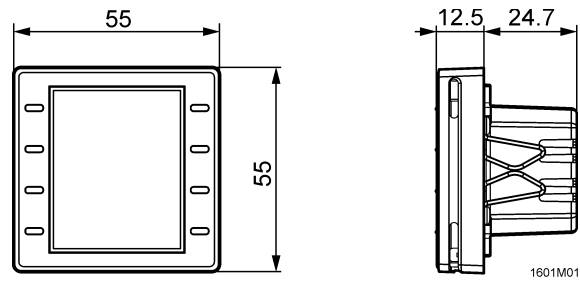

Bezel DELTA line (square)

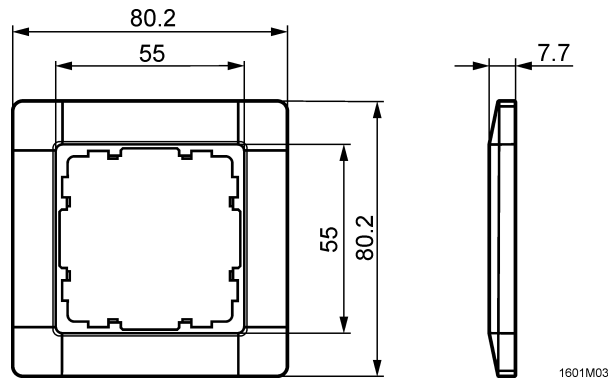

Base plate square

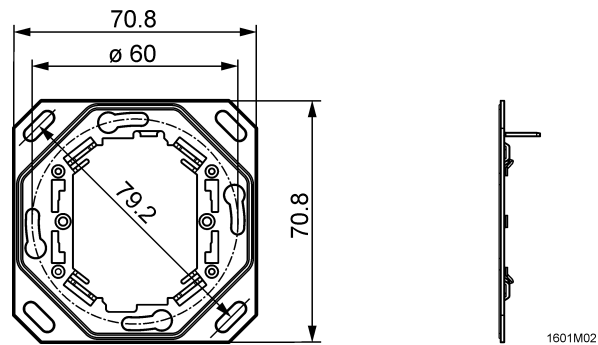

Bezel similar to DELTA azio (rectangular)

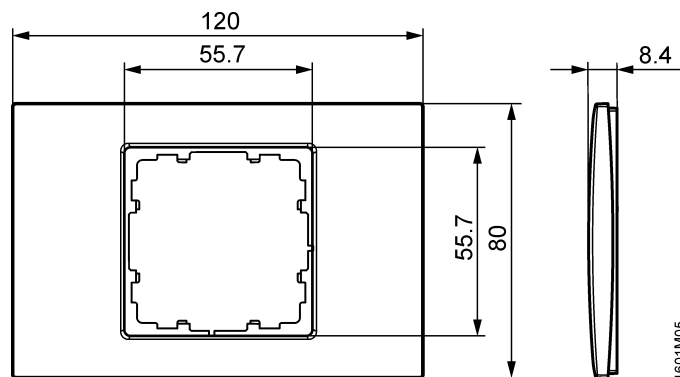

Base plate rectangular

