

pRack pR300

compressor rack controller

CAREL



ENG User manual

**LEGGI E CONSERVA
QUESTE ISTRUZIONI**

**READ AND SAVE
THESE INSTRUCTIONS**

**NO POWER
& SIGNAL
CABLES
TOGETHER**

READ CAREFULLY IN THE TEXT!

High Efficiency Solutions

IMPORTANT



CAREL bases the development of its products on decades of experience in HVAC, on the continuous investments in technological innovations to products, procedures and strict quality processes with in-circuit and functional testing on 100% of its products, and on the most innovative production technology available on the market. CAREL and its subsidiaries nonetheless cannot guarantee that all the aspects of the product and the software included with the product respond to the requirements of the final application, despite the product being developed according to start-of-the-art techniques.

The customer (manufacturer, developer or installer of the final equipment) accepts all liability and risk relating to the configuration of the product in order to reach the expected results in relation to the specific final installation and/or equipment. CAREL may, based on specific agreements, act as a consultant for the positive commissioning of the final unit/application, however in no case does it accept liability for the correct operation of the final equipment/system.

The CAREL product is a state-of-the-art product, whose operation is specified in the technical documentation supplied with the product or can be downloaded, even prior to purchase, from the website www.CAREL.com.

Each CAREL product, in relation to its advanced level of technology, requires setup / configuration / programming / commissioning to be able to operate in the best possible way for the specific application. The failure to complete such operations, which are required/indicated in the user manual, may cause the final product to malfunction; CAREL accepts no liability in such cases.

Only qualified personnel may install or carry out technical service on the product. The customer must only use the product in the manner described in the documentation relating to the product.

In addition to observing any further warnings described in this manual, the following warnings must be heeded for all CAREL products:

- Prevent the electronic circuits from getting wet. Rain, humidity and all types of liquids or condensate contain corrosive minerals that may damage the electronic circuits. In any case, the product should be used or stored in environments that comply with the temperature and humidity limits specified in the manual.
- Do not install the device in particularly hot environments. Too high temperatures may reduce the life of electronic devices, damage them and deform or melt the plastic parts. In any case, the product should be used or stored in environments that comply with the temperature and humidity limits specified in the manual.
- Do not attempt to open the device in any way other than described in the manual.
- Do not drop, hit or shake the device, as the internal circuits and mechanisms may be irreparably damaged.
- Do not use corrosive chemicals, solvents or aggressive detergents to clean the device.
- Do not use the product for applications other than those specified in the technical manual.

All of the above suggestions likewise apply to the controllers, serial boards, programming keys or any other accessory in the CAREL product portfolio. CAREL adopts a policy of continual development. Consequently, CAREL reserves the right to make changes and improvements to any product described in this document without prior warning.

The technical specifications shown in the manual may be changed without prior warning.

The liability of CAREL in relation to its products is specified in the CAREL general contract conditions, available on the website www.CAREL.com and/or by specific agreements with customers; specifically, to the extent where allowed by applicable legislation, in no case will CAREL, its employees or subsidiaries be liable for any lost earnings or sales, losses of data and information, costs of replacement goods or services, damage to things or people, downtime or any direct, indirect, incidental, actual, punitive, exemplary, special or consequential damage of any kind whatsoever, whether contractual, extra-contractual or due to negligence, or any other liabilities deriving from the installation, use or impossibility to use the product, even if CAREL or its subsidiaries are warned of the possibility of such damage.

DISPOSAL

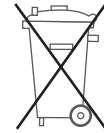

INFORMATION FOR USERS ON THE CORRECT HANDLING OF WASTE ELECTRICAL AND ELECTRONIC EQUIPMENT (WEEE)

In reference to European Union directive 2002/96/EC issued on 27 January 2003 and the related national legislation, please note that:

1. WEEE cannot be disposed of as municipal waste and such waste must be collected and disposed of separately;
2. the public or private waste collection systems defined by local legislation must be used. In addition, the equipment can be returned to the distributor at the end of its working life when buying new equipment;
3. the equipment may contain hazardous substances: the improper use or incorrect disposal of such may have negative effects on human health and on the environment;
4. the symbol (crossed-out wheeled bin) shown on the product or on the packaging and on the instruction sheet indicates that the equipment has been introduced onto the market after 13 August 2005 and that it must be disposed of separately;
5. in the event of illegal disposal of electrical and electronic waste, the penalties are specified by local waste disposal legislation.

Warranty on the materials: 2 years (from the date of production, excluding consumables).

Approval: the quality and safety of CAREL INDUSTRIES Hqs products are guaranteed by the ISO 9001 certified design and production system.

WARNING: separate as much as possible the probe and digital input signal cables from the cables carrying inductive loads and power cables to avoid possible electromagnetic disturbance.
Never run power cables (including the electrical panel wiring) and signal cables in the same conduits.

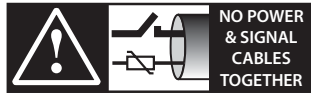

NO POWER & SIGNAL CABLES TOGETHER

READ CAREFULLY IN THE TEXT!

Key icone

	NOTE:	to bring attention to a very important subject; in particular, regarding the practical use of the various functions of the product.
	IMPORTANT:	to bring critical issues regarding the use of the pRack pR300 to the attention of the user.
	TUTORIAL:	some simple examples to accompany the user in configuring the most common settings.

Content

1. INTRODUCTION	7
1.1 Main features	7
1.2 Components and accessories.....	7
1.3 Configuration of the system and configuration of the inputs and outputs.....	8
2. HARDWARE CHARACTERISTICS AND INSTALLATION	9
2.1 pRack pR300 S, M, D, L board description	9
2.2 Technical specifications	11
2.3 pRack pR300 S, M, D, L board dimensions.....	16
2.4 pRack pR300 general connection diagram	17
3. INSTALLATION	22
3.1 General installation instructions.....	22
3.2 Power supply	22
3.3 Universal inputs/outputs.....	22
3.4 Connecting the digital inputs.....	24
3.5 Connecting the analogue outputs.....	25
3.6 Connecting the digital outputs.....	25
3.7 pLAN electrical connections.....	26
4. START UP	27
4.1 Starting the first time.....	27
5. USER INTERFACE	29
5.1 Graphic terminal.....	29
5.2 Description of the display.....	29
5.3 Password.....	31
5.4 Description menu.....	31
6. FUNCTIONS	33
6.1 Unit On-Off.....	33
6.2 Control	33
6.3 Compressors.....	36
6.4 Fans.....	42
6.5 Energy saving	44
6.6 Accessory functions.....	44
6.7 Settings.....	50
6.8 Managing the default values	50
7. PARAMETERS TABLE	51
8. ALARMS	75
8.1 Alarm management.....	75
8.2 Compressor alarms	75
8.3 Pressure and prevent alarms.....	76
9. SUPERVISORY AND COMMISSIONING SYSTEMS	78
9.1 PlantVisor PRO and PlantWatch PRO supervisory systems.....	78
9.2 Commissioning software	78
10. UPDATING THE SOFTWARE	79
10.1 Updating using pRack Manager	79
10.2 Updating using SmartKey.....	79
10.3 Pendrive: operating instructions	79
10.4 Configuring pCOWeb/pCOnet from a system screen.....	83
10.5 Saving parameters between different software versions	84
11. APPENDIX	85

1. INTRODUCTION

1.1 Main features

pRack pR300 is the evolution of the pR100 electronic controller. The consolidated software for management of compressor racks is combined with new functions, on a totally upgraded hardware platform. Below are the main functions (new and consolidated) and compressor management features on pRack pR300.

1.1.1 pR300 functionality list

Main features	Direct management via Fieldbus, using either the built-in driver (PRK300D*) or external driver, of one or two valves for the operation of heat exchangers typically used in subcritical systems (CO ₂)
	Up to 2 suction line and 2 condensing line
	Scroll, reciprocating, digital scroll and screw compressors management
	Up to 12 scroll compressors, reciprocating for line
	Up to 2 screw compressors for line 1, maximum one screw compressors line
	Fino a 2 compressori Bitzer CR11 (massimo 1 per linea)
	Up to 16 fans for line
	Inverter for suction and condensing line
	Generic functions easily configurable (ON/OFF, modulations, alarms, scheduler)
	Heat recovery
Hardware	S, M, D, L version (based on pRack hardware)
	External display (pGDE) or built-in display
Compressors	Up to 12 piston compressors per line, a maximum of 4 different sizes
	Up to 4 alarms per compressor
	Inverter management, even with modulation inside the dead zone Pump down
Languages	Control of overheating in suction
	Italian, English, German, French, Spanish, Russian, Portuguese, Swedish
Unit of measure	Temperature: °C, °F
	Pressure: barg, psig (all pressure values are also converted to temperature)
Control	Date format settable between: dd/mm/yy, mm/dd/yy, yy.mm.dd
	Proportional band (P, PI) available for compressors and fans Neutral zone available for compressors and fans
Compressor rotation	FIFO
	LIFO
Scheduling by calendar	Timed
	Fixed (the ON/OFF order can be set as required)
	Scheduling available: heating/cooling, 4 daily time bands, 5 special periods (e.g.: closing period), 10 special days (e.g.: holidays)
	Schedulable functions: set point compensation for compressors and fans, split condenser (heating/cooling only), anti noise, heat recovery, generic functions
Setpoint	Compensation from digital input, from scheduling, floating based on supervisor parameter (compressors) or outside temperature (fans)
Prevent	High pressure, including activation of heat recovery or ChillBooster
Alarms	Automatic and manual management
	Configurable compressor alarms
	Double Signal on digital outputs for high or low priority alarms
Supervisor protocol	Log from application
	Carel
	Modbus®

Tab. 1.a

1.2 Components and accessories

The pRack pR300 is available in 4 hardware sizes listed in the table (for the detailed description of each size, electrical characteristics and installation, refer to Chapter 2):

Hardware sizes:

Size	Available analog inputs	Available digital inputs	Available analog outputs	Available digital outputs
Small	5	8	4	8
Medium	8	14	4	13
Medium + Driver	8	14	4	13
Large	10	18	6	18

Tab. 1.b

For each size the following versions are available:

- with built-in terminal, without terminal

All pRack pR300 models are equipped with:

- integrated RS485 serial interface
- anthracite gray plastic cover
- connector kit
- USB.

pRack pR300 models

Code	Description
PRK300S0F0	pRack pR300 small, USB, no display, BMS/FBUS opto, connector kit,
PRK300S0E0	pRack pR300 small, USB, no display, BMS/FBUS opto, 2 SSR, connector kit,
PRK300M0F0	pRack pR300 medium, USB, no display, BMS/FBUS opto, connector kit,
PRK300M0E0	pRack pR300 medium, USB, no display, BMS/FBUS opto, 2 SSR, connector kit,
PRK300D0F0	pRack pR300 medium, EVD EVO embedded for 2 univ. EXV, USB, no display, BMS/FBUS opto, connector kit,
PRK300D0E0	pRack pR300 medium, EVD EVO embedded for 2 univ. EXV, USB, no display, BMS/FBUS opto, 2 SSR, connector kit,
PRK300L0F0	pRack pR300 large, USB, no display, BMS/FBUS opto, connector kit
PRK300L0E0	pRack pR300 large, USB, no display, BMS/FBUS opto, 6 SSR, connector kit,
PRK300S3F0	pRack pR300 small, USB, display built-in, BMS/FBUS opto, connector kit,
PRK300S3E0	pRack pR300 small, USB, display built-in, BMS/FBUS opto, 2 SSR, connector kit,
PRK300M3F0	pRack pR300 medium, USB, display built-in, BMS/FBUS opto, connector kit,
PRK300M3E0	pRack pR300 medium, USB, display built-in, BMS/FBUS opto, 2 SSR, connector kit
PRK300D3F0	pRack pR300 medium, EVD EVO embedded for 2 univ. exv, USB, display built-in, BMS/FBUS opto, connector kit
PRK300D3E0	pRack pR300 medium, EVD EVO embedded for 2 univ. exv, USB, display built-in, bms/fbus opto, 2 SSR, connector kit
PRK300L3F0	pRack pR300 large, USB, display built-in, BMS/FBUS opto, connector kit
PRK300L3E0	pRack pR300 large, USB, display built-in, BMS/FBUS opto, 6 ssr, connector kit
PRK300S3FK	pRack pR300 small, USB, external display, BMS/FBUS opto, connector kit
PRK300M3FK	pRack pR300 medium, USB, external display, BMS/FBUS opto, connector kit
PRK300D3FK	pRack pR300 medium, EVD EVO embedded for 2 univ. EXV, USB, external display, BMS/FBUS opto, connector kit
PRK300L3FK	pRack pR300 large, USB, external display, BMS/FBUS opto, connector kit

Tab. 1.c

Accessories:

Code	Description
PGDERK0FX0	pGD evolution user terminal for pRack pR300T
CONVONOFF0	Module to convert a 0...10 V analog output to an SPDT digital output
PCOS004850	RS485 serial connection board
CVSTDUTLFO	USB/RS485 serial converter with telephone connector
CVSTDUMORO	USB/RS485 serial converter with 3-way terminal
PCOS00AKY0	Smart Key programming key
S90CONN002	Connection cable for terminal 1=0.8m
S90CONN000	Connection cable for terminal 1=1.5m
S90CONN001	Connection cable for terminal 1=3 m
SPKT*R* and SPKC00*	Ratiometric pressure probes 0...5 Vdc
SPK*C*, SPK1*, SPK2*, SPK3*	Active pressure probes 4...20 mA
NTC*	Pressure probe NTC -50T90°C
NTC*HT*	Pressure probe NTC -0T150°C
EVD0000E50	EVD EVO universal driver for Carel valves, RS485/Modbus™
EVDIS00D*0	Display for EVD EVO
E2VCABS*00	EVD-valve connection cable

Tab. 1.d

1.3 Configuration of the system and configuration of the inputs and outputs

pRack pR300 has the same system, input and output configuration management as the standard pRack pR100. It is available 22 configurations, but it is more utilised those described in Appendix A.1.

Note: each input/output is completely configurable with the only requirements being those set by the system configuration. For example, the suction pressure probe on line 1 can be arbitrarily configured to any one of the analog inputs in the pLAN control board with address 1 compatible with the type of probe.

Refer Cap. 4, to have more information about selection of configuration system and pre-configuration and see Appendix A.1.

1.3.1 System configurations available

pRack pR300 can manage system configurations with up to 2 suction lines (maximum 12 scroll or piston compressors for lines 1 and 2, maximum 2 screw compressors for line 1 and maximum 1 BitzerCR11 compressor per line), up to 2 condenser lines (maximum 16 fans per line). When there are two suction lines, the 2 lines can be managed by the same pRack board or by separate boards. The condenser lines can be managed by the board controls the suction lines or by separate boards, depending on the number of inputs/outputs available. For each suction and condenser line, pRack pR300 can manage a modulating device (inverter, Digital Scroll® compressor, compressor with continuous control or BitzerCR11 compressor). pRack pR300 manages up to 1 line with screw compressors, and the board can control up to 2 compressors.

Some examples of managed system configurations are described below, while for the complete list of configurations and its features refer to Appendix A1.

Example 1: 1 suction line with scroll or piston compressors, 1 high pressure line:

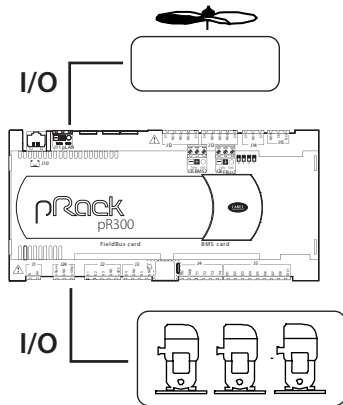

Fig. 1.a

Example 2: 2 suction lines on the same board with scroll or piston compressors, 1 high pressure line:

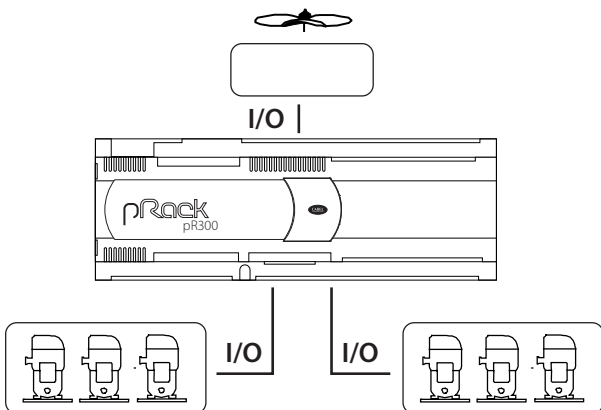

Fig. 1.b

Example 4: 2 suction lines on board (scroll or piston compressors), 2 high pressure lines on the board:

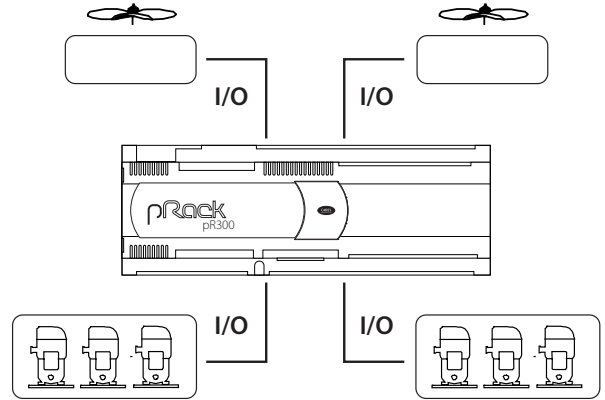

Fig. 1.c

Example 4: 2 suction lines on separate boards (scroll or piston compressors), 2 high pressure lines (on the first suction line board):

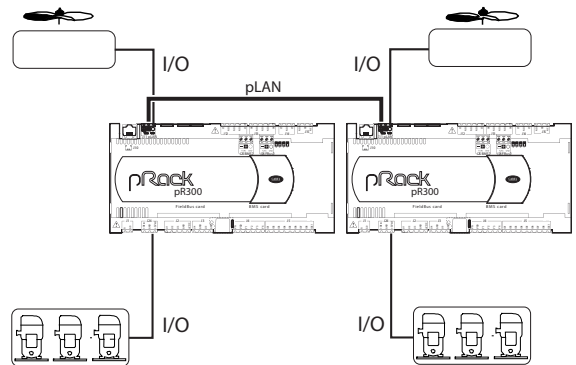

Fig. 1.d

Example 5: 2 suction lines on separate boards with scroll or piston compressors, 2 high pressure line on separate board

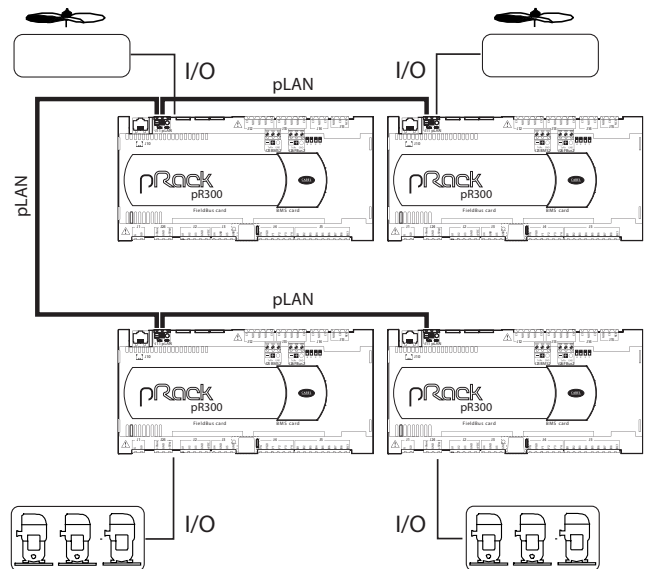

Fig. 1.e

Note: nel caso di collegamento in pLAN di più schede pRack pR300, non è possibile realizzare reti miste con schede di taglia Compact insieme a schede di tipo S, M, L, mentre risultano possibili reti miste che utilizzino combinazioni di queste ultime.

Important: all the boards connected to the pLAN must have the same software revision.

2. HARDWARE CHARACTERISTICS AND INSTALLATION

2.1 pRack pR300 S, M, D, L board description

pRack pR300 S

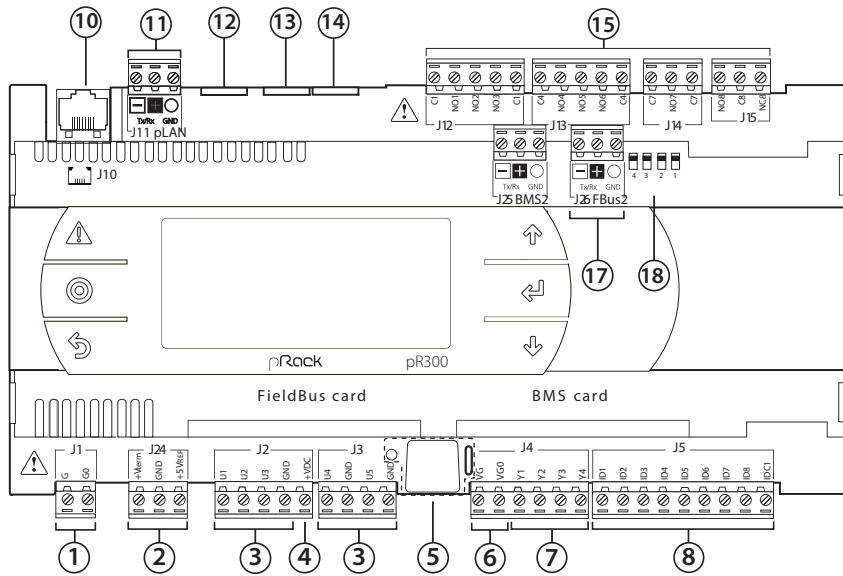

Fig. 2.a

pRack pR300 M

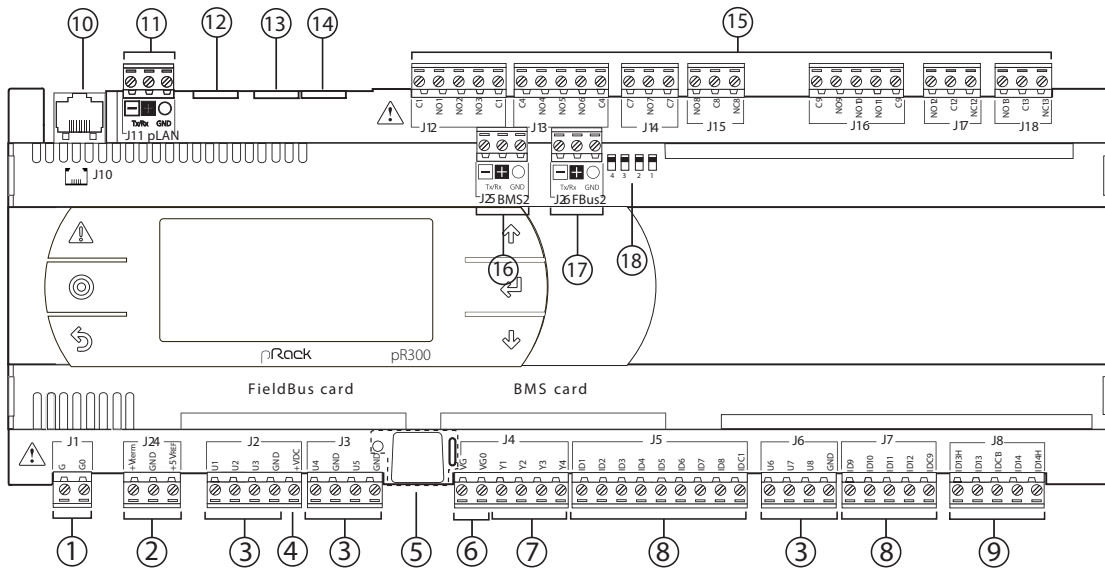

Fig. 2.b

Legende:

Rif.	Description
1	Power supply connector [G(+), G0(-)]
2	+Vterm: power supply for additional terminal +5 VREF power supply for ratiometric probes
3	Universal inputs/outputs
4	+VDC: power supply for active probes
5	Button for setting pLAN address, second display, LED
6	VG: power supply at voltage A(*) for opto-isolated analogue output VG0: power to opto-isolated analogue output, 0 Vac/Vdc
7	Analogue outputs
8	ID: digital inputs for voltage A (*)
9	ID.: digital inputs for voltage A (**)
9	IDH.: digital inputs for voltage B (**)
10	pLAN telephone connector for terminal/downloading application

(*) Voltage A: 24 Vac or 28 to 36 Vdc; (**) Voltage B: 230 Vac - 50/60 Hz.

Rif.	Description
11	pLAN plug-in connector
12	Reserved
13	Reserved
14	Reserved
15	Relay digital outputs
16	BMS2 connector
17	FieldBus2 connector
18	Jumpers for selecting FieldBus/ BMS

Tab. 2.a

pRack pR300 D

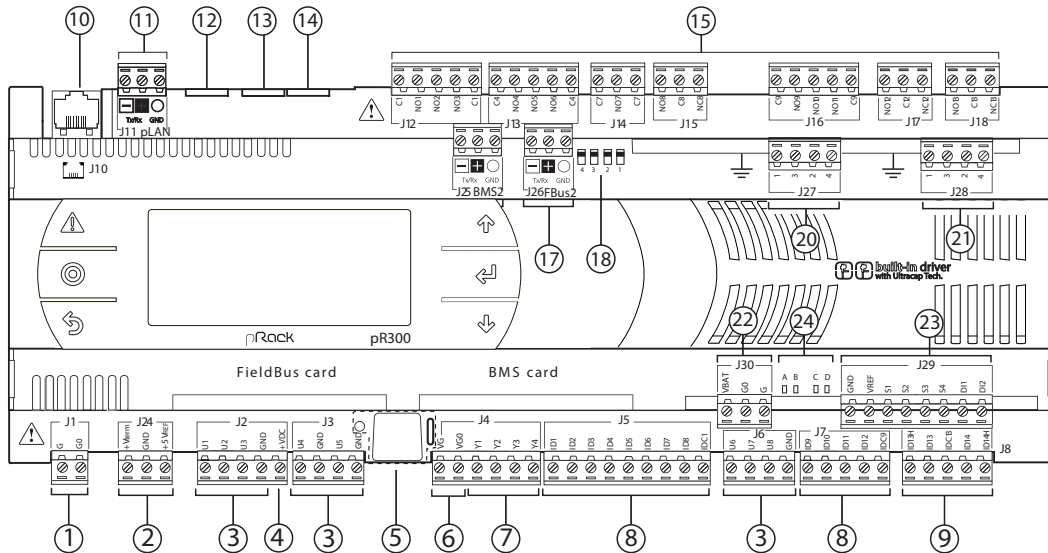

Fig. 2.c

Legende:

Ref.	Description	Ref.	Description
1	Power supply connector [G(+), G0(-)]	13	Reserved
2	+Vterm: power supply for additional terminal +5 VREF power supply for ratiometric probes	14	Reserved
3	Universal inputs/outputs	15	Relay digital outputs
4	+VDC: power supply for active probes	16	BMS2 connector
5	Button for setting pLAN address, second display, LED	17	FieldBus2 connector
6	VG: power supply at voltage A(*) for opto-isolated analogue output VG0: power to opto-isolated analogue output, 0 Vac/Vdc	18	Jumpers for selecting FieldBus/ BMS
7	Analogue outputs	20	Electronic valve A connector
8	ID: digital inputs for voltage A (*)	21	Electronic valve B connector
9	ID...: digital inputs for voltage A (*); IDH...: digital inputs for voltage B (**)	22	Connector for external Ultracap module (accessory)
10	pLAN telephone connector for terminal/downloading application	23	Valve driver analogue and digital inputs
11	pLAN plug-in connector	24	Valve status signal LED
12	Reserved		

Tab. 2.b

pRack pR300 L

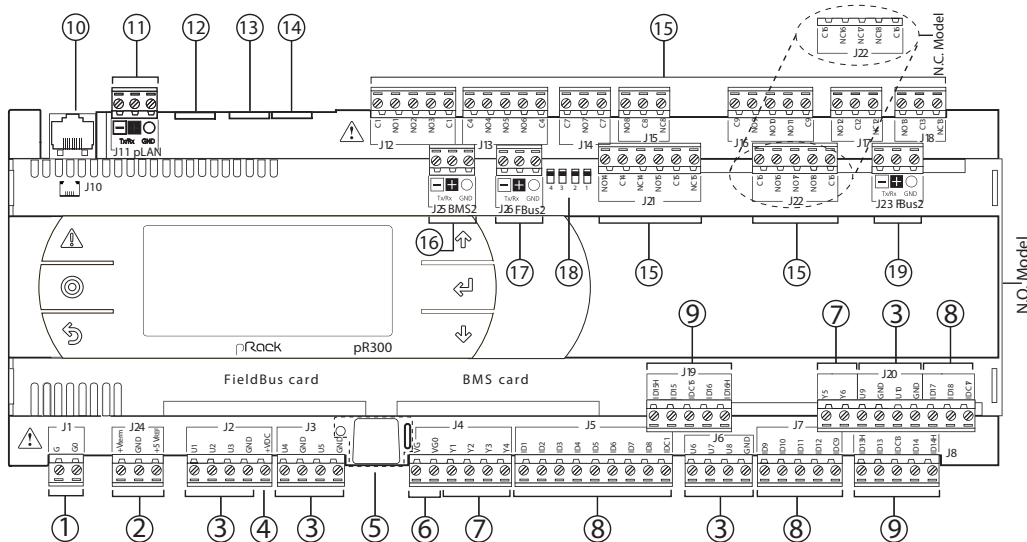

Fig. 2.d

Legende:

Ref.	Description	Ref.	Description
1	Power supply connector [G(+), G0(-)]	11	pLAN plug-in connector
2	+Vterm: power supply for additional terminal +5 VREF power supply for ratiometric probes	12, 13, 14	Reserved
5	Button for setting pLAN address, second display, LED	15	Relay digital outputs
6	VG: power supply at voltage A(*) for opto-isolated analogue output VG0: power to opto-isolated analogue output, 0 Vac/Vdc	16	BMS2 connector
7	Analogue outputs	17	FieldBus2 connector
8	ID: digital inputs for voltage A (*)	18	Jumpers for selecting FieldBus/ BMS
9	ID...: digital inputs for voltage A (*); IDH...: digital inputs for voltage B (**)	19	FieldBus2 connector
10	pLAN telephone connector for terminal/downloading application		

Tab. 2.c

2.2 Technical specifications

2.2.1 Physical specifications

Dimensions	SMALL	13 DIN modules	110 x 227,5 x 60 mm
	MEDIUM, LARGE,	18 DIN modules	110 x 315 x 60 mm
	BUILT-IN DRIVER	18 DIN modules	110 x 315 x 75 mm
Plastic case	Assembly	fitted on DIN rail in accordance with DIN 43880 CEI EN 50022	
	Material	technopolymer	
	Flammability	V2 (UL94) and 850 °C (in accordance with IEC 60695)	
	Ball pressure test	125 °C	
	Resistance to creeping current	≥ 250 V	
Built-in terminal	Colour	White RAL 9016	
	PGD1 (132x64 pixel) with backlit keypad		
Other features	Operating conditions	PRK300*3**, PRK300*0**(w/o built-in terminal): -40T70 °C, 90% RH non-condensing(*) PRK300*3*0 (with built-in terminal): -20T60 °C, 90% RH non-condensing (*) with Ultracap module fitted: -40T60°C	
	Storage conditions	PRK300D*** (w/o built-in terminal): -40T70 °C, 90% RH non-condensing PRK300D*** (with built-in terminal): -30T70 °C, 90% RH non-condensing	
	Ingress protection	Models with USB port and/or with Ultracap module: IP20 on the front panel only Models without USB port and without Ultracap module: IP40 on the front panel only	
	Environmental pollution	2	
	Class according to protection against electric shock	to be integrated into Class I and/or II appliances in the versions without valve driver, class I in the versions with valve driver	
	PTI of the insulating materials	PCB: PTI 250 V; insulating material: PTI 175	
	Period of stress across the insulating parts	long	
	Type of action	1C; 1Y for SSR versions	
	Type of disconnection or microswitching	microswitching	
	Heat and fire resistance category	Category D (UL94-V2)	
	Ageing characteristics (operating hours)	80,000	
	Number of automatic operating cycles	100,000 (EN 60730-1); 30,000 (UL 873)	
Overvoltage category	category II		

Tab. 2.d

2.2.2 Electrical specifications

Power supply	SMALL, MEDIUM, LARGE: use a dedicated 50 class II safety transformer VA.				
	BUILT IN DRIVER: use a dedicated 100 VA class II safety transformer.				
		Vac	P (Vac)	Vdc	P (Vdc)
	SMALL	24 Vac (+10/-15%),	45 VA	28 to 36 Vdc (-20/+10%) protected by an external 2.5 A type T fuse	30 W
	MEDIUM	50/60 Hz protected			
	LARGE	by an external 2.5 A			
(EXTRALARGE)	type T fuse				
BUILT-IN DRIVER (DRIVER VALVE INTEGRATED)		90 VA		Not allowed	

Important: only power *PRK300TD*** with alternating current. The power transformer secondary **must** be earthed.

Terminal block	with male/female plug-in connectors
Cable cross-section	min 0.5 mm ² - max 2.5 mm ²
CPU	32 bit, 100 MHz
Non-volatile memory (FLASH)	2 M byte Bios + 11 Mbyte application program
Data memory (RAM)	3.2 Mbyte (1.76 Mbyte Bios + 1.44 Mbyte application program)
T buffer memory (EEPROM)	13 kbyte
P parameter memory(EEPROM)	32 kbyte (not available to the pLAN)
Clock with battery	standard, precision 100 ppm
Battery	CR2430 3 Vdc lithium button battery (size 24x3 mm)
Software class and structure	Class A
Category of immunity to voltage surges (EN 61000-4-5)	Category III
Device not designed to be hand-held when powered	

Tab. 2.e

2.2.3 Universal inputs/outputs U...

Analogue inputs, L _{max} = 30 m (maximum number)		SMALL	MEDIUM/ BUILT-IN DRIVER/EXTRALARGE	LARGE
	- CAREL NTC probes (-50T90°C; R/T 10 kΩ±1% at 25°C); - HT NTC (0T150°C); - PTC (600Ω to 2200Ω) - PT500 (-100T400°C) - PT1000 (-100T400°C) - PT100 probes (-100T200°C)	5	8	10
	- 0 to 1 Vdc/0 to 10 Vdc signals from probes powered by controller	2	3 (2 on U1...U5, 1 on U6...U8)	4 (2 on U1...U5, 1 on U6...U8, 1 su U9...U10)
	- 0 to 1 Vdc/0 to 10 Vdc signals powered externally	max tot 5	5 max tot 8	6 max tot 10
	- 0 to 20 mA /4 to 20 mA inputs from probes powered by the controller	4	6 (max 4 on U1...U5, 3 on U6...U8)	6 (max 4 on U1...U5, 3 on U6...U8, 2 on U9...U10)
	- 0 to 20 mA /4 to 20 mA inputs powered externally	max tot 4	4 max tot 7	7 max tot 9
- 0 to 5 V signals from ratiometric probes powered by controller Input precision: ± 0.3 % f.s. Time constant for each input: 0.5 s Classification of measuring circuits (CEI EN 61010-1): category I				
Digital inputs w/o optical isolation, L _{max} = 30 m (maximum number)		SMALL	MEDIUM/ BUILT-IN DRIVER/EXTRALARGE	LARGE
	- voltage-free contacts - fast digital inputs type: voltage-free contact max current: 10 mA max frequency 2kHz and resolution ±1 Hz	5	8	10



Important:

- for active probes powered externally (0 to 1 V, 0 to 10 V, 0 to 20 mA, 4 to 20 mA), to avoid irreparably damaging the controller, implement adequate current protection measures that must ensure < 100 mA;
- the ratiometric probes can only be powered by the controller;
- on power-up, the universal inputs/outputs remain shorted to GND for around 500 ms until the end of the configuration procedure.

Analogue outputs w/o optical isolation (maximum number), L _{max} = 30 m		SMALL	MEDIUM/ BUILT-IN DRIVER/EXTRALARGE	LARGE
	0 to 10 Vdc (maximum current 2 mA) PWM (output 0/3.3 Vdc, maximum current 2 mA, frequency: 2kHz asynchronous)	5	8	10

Tab. 2.f

2.2.4 Power supply to probes and terminals

+Vdc	can be used to power any active probes using the 24/21 Vdc ± 10% (P+5*/P+3*) available at terminal +VDC (J2). The maximum current available is 150 mA, protected against short-circuits.
+5Vref	to power the 0 to 5V ratiometric probes, use the 5 Vdc (± 5%) available at terminal +5VREF(J24). The maximum current available is 60 mA.
Vterm	P+3*****: 21 Vdc ± 10%; P+5*****: 24 Vdc ± 10% Used to power an external terminal as an alternative to the one connected to J10, P _{max} = 1.5 W

Important: if the length exceeds 10 m, use shielded cable with the shield connected to earth. In any case, the max length allowed is 30 m.

Tab. 2.g

2.2.5 Digital inputs ID... IDH...

Type	Optically-isolated			
L _{max}	30 m			
Maximum number	no. of optically-isolated inputs, 24 Vac or 24 Vdc	8	no. of optically-isolated inputs, 24 Vac/Vdc or 230 Vac - 50/60 Hz	None
	SMALL	12	MEDIUM/ BUILT-IN DRIVER/EXTRALARGE	2
	LARGE	14	LARGE	4
Minimum digital input pulse detection time	Normally open (open-closed-open)	200 ms		
	Normally closed (closed-open-closed)	400 ms		
Power supply to the inputs	External	IDH...: 230 Vac (+10/-15%) 50/60 Hz		
		ID...: 24 Vac (+10/-15%) 50/60 Hz o 28 to 36 Vdc (+10/-20%)		
Classification of measuring circuits (CEI EN 61010-1)	Category I: 24 Vac/Vdc (J5, J7, J20)			
	Category III: 230 Vac (J8, J19)			
Digital input current draw at 24 Vac/Vdc	5 mA			
Digital input current draw at 230 Vac	5 mA			

Tab. 2.h



Note:

- separate as much as possible the probe and digital input cables from cables to inductive loads and power cables, so as to avoid possible electromagnetic disturbance. Never run power cables (including the electrical panel cables) and signal cables in the same conduits;
- the two 230 Vac or 24 Vac/Vdc inputs on terminals J8 (ID13, ID14) or J19 (ID15, ID16) have the same common pole and therefore both will operate at 230 Vac or 24 Vac/Vdc. There is basic insulation between the two inputs; there is reinforced insulation between the inputs and the rest of the controller;
- ID1...ID8, ID9 to ID12, ID17, ID18 have functional insulation from the rest of the controller;
- for DC voltage inputs (24 Vdc) either the + or the - can be connected to common terminal;
- the rating of the external contact connected to the digital inputs must be at least 5 mA.

2.2.6 Analogue outputs Y...

Type	0 to 10 V optically-isolated on Y1...Y6		
Lmax	30 m		
Maximum number	SMALL, MEDIUM/ BUILT-IN DRIVER	4	Y1...Y4, 0 to 10 V
	LARGE	6	Y1...Y6, 0 to 10 V
Power supply	external	24 Vac (+10/-15%) or 28 to 36 Vdc on VG(+), VG0(-)	
Precision	Y1...Y6	± 2% full scale	
Resolution	8 bit		
Settling time	Y1...Y6	from 1 s (slew rate 10 V/s) to 20 s (slew rate 0.5 V/s) selectable via SW	
Maximum load	1 kΩ (10 mA)		

Tab. 2.i



- Warnings:**
- for lengths > 10 m, only use shielded cable, with the shield connected to earth;
 - a 0 to 10Vdc analogue output can be connected in parallel to other outputs of the same type, or alternatively to an external source of voltage. The higher voltage will be considered. Correct operation is not guaranteed if actuators with voltage inputs are connected;
 - power the VG-VG0 analogue outputs at the same voltage on G-G0: Connect G0 to VG0 and G to VG. This is valid for both alternating and direct current power supplies.

2.2.7 Digital outputs NO..., NC...

Type	Relay. Minimum contact current: 50 mA.											
Maximum no	8: SMALL; 13: MEDIUM/ BUILT-IN DRIVER; 18: LARGE;											
Insulation distance	The relay outputs have different features depending on the model of controller. The outputs can be divided into groups. The relays belonging to the same group (individual cell in the table) have basic insulation and therefore must have the same voltage. Between groups (cells in the table) there is double insulation and consequently these may have different voltages. There is also double insulation between each terminal of the digital outputs and the rest of the controller.											
Relays with the same insulation												
		Group										
		1	2	3	4	5	6	7	8	9	10	11
Makeup of the groups	Model	SMALL	1...3	4..6	7	8	-	-	-	-	-	-
	Type of relay	Type A	Type A	Type A	Type A	-	-	-	-	-	-	-
	Model	MEDIUM/ BUILT-IN DRIVER	1...3	4..6	7	8	9...11	12	13	-	-	-
	Type of relay	Type A	Type A	Type A	Type A	Type A	Type A	Type A	Type A	-	-	-
	Model	LARGE NO	1...3	4..6	7	8	9...11	12	13	14..15	16..18	-
	Type of relay	Type A	Type A	Type A	Type A	Type A	Type A	Type A	Type A	Type A	Type A	-
Model	LARGE NC	1...3	4..6	7	8	9...11	12	13	14..15	16..18	-	
Type of relay	Type A	Type A	Type A	Type A	Type A	Type A	Type A	Type A	Type A	Type C	-	
Number of changeover contacts	1: SMALL (relay 8) 3: MEDIUM (relay 8, 12, 13) 5: LARGE NO/NC (relay 8, 12, 13, 14 e 15)											

Note: the output relays have different features, depending on the model of controller.

Switchable power	Relay type A	Rated data	SPDT, 2000 VA, 250 Vac, 8A resistive	
		Approval	UL 873	2 A 250 Vac resistive, 2A FLA, 12 LRA, 250 Vac, C300 pilot duty (30,000 cycles)
	Relay type B	Relay rated data	SPST, 1250 VA, 250 Vac, 5A resistive	
		Approval	UL 873	1 A 250 Vac resistive, 1A FLA, 6 LRA, 250 Vac, C300 pilot duty (30,000 cycles)
	Relay type C	Relay rated data	SPDT, 1250 VA, 250 Vac, 5A resistive	
		Approval	UL 873	1 A 250 Vac resistive, 1A FLA, 6 LRA, 250 Vac, C300 pilot duty (30,000 cycles)

Tab. 2.a

2.2.8 SSR outputs (in models where featured)

Maximum number	2: SMALL (ouputs 7, 8); 2: MEDIUM (ouputs 7, 12); 6: LARGE (ouputs 7, 8, 12, 13, 14, 15)	
Working voltage	24 Vac/Vdc	
Load current (MAX)	1 A	
Impulsive load current (MAX)	1.2 A	

Tab. 2.j



- Warnings:**
- if the load requires higher current, use an external SSR;
 - to power external resistive loads via SSRs, use the same power supply as the pRack (supplied to terminals G-G0), which must be dedicated and not shared by other devices (contactors, coils, etc.);
 - the groups that the digital outputs are divided into have two common pole terminals to simplify wiring;
 - make sure that the current running through the common terminals does not exceed the rated current of an individual terminal, that is, 8 A.

2.2.9 Serial port - Use AWG 20-22 twisted pair shielded cable for the +/-

Serial	Type/connectors	Features
Serial ZERO	pLAN/J10, J11	<ul style="list-style-type: none"> Integrated on main board HW driver: asynchronous half duplex RS485 pLAN Not optically-isolated Connectors: 6-pin telephone jack + 3-pin plug-in p. 5.08 Maximum length: 500 m Max data rate: 115200 bit/s Maximum number of connectable devices: 3
Serial ONE	BMS 1 Serial Card	<ul style="list-style-type: none"> Not integrated on main board HW driver: not featured Can be used with all pRack family optional BMS cards
Serial TWO	FieldBus 1 Serial Card	<ul style="list-style-type: none"> Not integrated on main board HW driver: not present Can be used with all pRack family optional FieldBus cards
Serial THREE	BMS 2 / J25	<ul style="list-style-type: none"> Integrated on main board HW driver: asynchronous half duplex RS485 Slave Optically-isolated 3-pin plug-in connector p. 5.08 Maximum length: 1000 m Max data rate: 384000 bit/s
Serial FOUR	FieldBus 2 / J26 (and J23 on Large and Extralarge version)	<ul style="list-style-type: none"> Integrated on main board J23: not optically-isolated J26: optically-isolated 3-pin plug-in connector p. 5.08 J23 and J26 are independent.

Tab. 2.k

 **Note:** in industrial/residential environments, for distances > 10 m, shielded cable is required, with the shield connected to earth. In residential environments (EN 55014), irrespective of the cable length, on versions without valve driver, the connection cable between the controller and the terminal and the serial cable must be shielded and connected to earth at both ends.

2.2.10 Model with electronic expansion valve driver

Valve compatibility	CAREL: E*V**** ALCO: EX4; EX5; EX6; EX7; EX8 330 Hz (recommended by CAREL); EX8 500 Hz (from ALCO specifications) SPORLAN: SEI 0.5-11; SER 1.5-20; SEI 30; SEI 50; SEH 100; SEH175 Danfoss: ETS 12.5-25B; ETS 50B; ETS 100B; ETS 250; ETS 400 CCM 40, CCM 10-20-30, CCMT 2-4-8 CAREL: two CAREL EXV as for EVD EVOLUTION TWIN SPORLAN: SER(I) G, J, K			
Motor connection	Shielded 4-wire cable CAREL P/N E2VCABS*00, or AWG22 shielded 4-wire cable Lmax =10 m, or AWG14 shielded 4-wire cable Lmax 50 m			
Digital input connection	Digital input to be activated with voltage-free contact or transistor to GND. Closing current 5mA; maximum length < 10 m			
Sonde	Maximum length 10 m or less than 30 m with shielded cable			
Sonde	S1	radiometric pressure probe (0 to 5 V)	resolution 0.1 % fs	measurement error: 2% fs maximum; 1% typical
		electronic pressure sensor (4 to 20 mA)	resolution 0.5 % fs	measurement error: 8% fs maximum; 7% typical
		combined radiometric pressure probe (0 to 5 V) 4 to 20 mA input (max. 24 mA)	resolution 0.1 % fs	measurement error: 2 % fs maximum; 1 % typical
	S2	low temperature NTC	10 kΩ at 25 °C, -50T90 °C	measurement error: 1°C in the range -50T50 °C; 3°C in the range +50T90 °C
		high temperature NTC	50 kΩ at 25 °C, -40T150 °C	measurement error: 1.5 °C in the range -20T115°C, 4 °C in range outside of -20T115 °C
		combined NTC	10 kΩ at 25 °C, -40T120 °C	measurement error: 1°C in the range -40T50 °C; 3°C in the range +50T90 °C
	S3	radiometric pressure probe (0 to 5 V): 0 to 10 V input (max 12 V)	resolution 0.1 % fs	measurement error: 9% fs maximum; 8% typical
		electronic pressure sensor (4 to 20 mA)	resolution 0.1 % fs	measurement error: 2% fs maximum; 1% typical
		combined radiometric pressure probe (0 to 5 V) 4 to 20 mA input (max. 24 mA)	resolution 0.5 % fs	measurement error: 8 % fs maximum; 7 % typical
	S4	low temperature NTC	10 kΩ at 25 °C, -50T105 °C	measurement error: 1 °C in the range -50T50 °C; 3°C in the range 50T90 °C
		high temperature NTC	10 kΩ at 25 °C, -40T150 °C	measurement error: 1.5 °C in the range -20T115 °C; 4 °C in range outside of -20T115 °C
		combined NTC	10 kΩ at 25 °C, -40T120 °C	measurement error 1 °C in the range -40T50 °C; 3°C in the range +50T90 °C
Power to active probes (VREF)	programmable output: +5 Vdc ±2% or 12 Vdc ±10%, I _{max} = 50 mA			
Emergency power supply	optional Ultracapacitor module (PCOS00UC20 or EVD0000UC0). If the controller operates constantly at temperatures near the upper limit of 60°C it's recommended to use the external module EVD0000UC0, where possible located in the coolest point of the panel. The PCOS00UC20 and EVD0000UC0 modules can be connected at the same time to the same controller, thus doubling the energy available to close the valves. Important: The module only powers the valve driver and not the controller.			

Tab. 2.l

2.2.11 Meaning of the inputs/outputs on the pRack pR300 S, M, L boards

Version	Connector	Signal	Description
	J1-1	G	+24 Vdc or 24 Vac power supply
	J1-2	G0	power supply reference
	J2-1	B1	universal analogue input 1 (NTC, 0 to 1 V, 0 to 5 V ratiometric, 0...10 V, 0...20 mA, 4...20 mA)
	J2-2	B2	universal analogue input 2 (NTC, 0 to 1 V, 0 to 5 V ratiometric, 0...10 V, 0...20 mA, 4...20 mA)
	J2-3	B3	universal analogue input 3 (NTC, 0 to 1 V, 0 to 5 V ratiometric, 0...10 V, 0...20 mA, 4...20 mA)
	J2-4	GND	common for analogue inputs
	J2-5	+VDC	21 Vdc power supply for active probes (maximum current 200 mA)
	J3-1	B4	passive analogue input 4 (NTC, PT1000, ON/OFF)
	J3-2	BC4	common for analogue input 4
	J3-3	B5	passive analogue input 5 (NTC, PT1000, ON/OFF)
	J3-4	BC5	common for analogue input 5
S, M, L	J4-1	VG	power to optically-isolated analogue output, 24 Vac/Vdc
	J4-2	VG0	power to optically-isolated analogue output, 0 Vac/Vdc
	J4-3	Y1	analogue output no. 1, 0...10 V
	J4-4	Y2	analogue output no. 2, 0...10 V
	J4-5	Y3	analogue output no. 3, 0...10 V
	J4-6	Y4	analogue output no. 4, 0...10 V
	J5-1	ID1	digital input no. 1, 24 Vac/Vdc
	J5-2	ID2	digital input no. 2, 24 Vac/Vdc
	J5-3	ID3	digital input no. 3, 24 Vac/Vdc
	J5-4	ID4	digital input no. 4, 24 Vac/Vdc
	J5-5	ID5	digital input no. 5, 24 Vac/Vdc
	J5-6	ID6	digital input no. 6, 24 Vac/Vdc
	J5-7	ID7	digital input no. 7, 24 Vac/Vdc
	J5-8	ID8	digital input no. 8, 24 Vac/Vdc
	J5-9	IDC1	common for digital inputs from 1 to 8 (negative pole for DC power supply)
	J6-1	B6	universal analogue input 6 (NTC, 0 to 1 V, 0 to 5 V ratiometric, 0...10 V, 0...20 mA, 4...20 mA)
	J6-2	B7	universal analogue input 7 (NTC, 0 to 1 V, 0 to 5 V ratiometric, 0...10 V, 0...20 mA, 4...20 mA)
	J6-3	B8	universal analogue input 8 (NTC, 0 to 1 V, 0 to 5 V ratiometric, 0...10 V, 0...20 mA, 4...20 mA)
	J6-4	GND	common for analogue inputs
	J7-1	ID9	digital input no. 9, 24 Vac/Vdc
M, L	J7-2	ID10	digital input no. 10, 24 Vac/Vdc
	J7-3	ID11	digital input no. 11, 24 Vac/Vdc
	J7-4	ID12	digital input no. 12, 24 Vac/Vdc
	J7-5	IDC9	common for digital inputs from 9 to 12 (negative pole for DC power supply)
	J8-1	ID13H	digital input no. 13, 230 Vac
	J8-2	ID13	digital input no. 13, 24 Vac/Vdc
	J8-3	IDC13	common for digital inputs 13 and 14 (negative pole for DC power supply)
	J8-4	ID14	digital input no. 14, 24 Vac/Vdc
	J8-5	ID14H	digital input no. 14, 230 Vac
	J9		8-pin telephone connector for connecting a display terminal (not used)
	J10		6-pin telephone connector for connecting the standard pGDE user terminal
	J11-1	RX-/TX-	RX-/TX- connector for RS485 connection to the pLAN network
	J11-2	RX+/TX+	RX+/TX+ connector for RS485 connection to the pLAN network
	J11-3	GND	GND connector for RS485 connection to the pLAN network
	J12-1	C1	common for relays: 1, 2, 3
	J12-2	NO1	normally open contact, relay no. 1
	J12-3	NO2	normally open contact, relay no. 2
	J12-4	NO3	normally open contact, relay no. 3
	J12-5	C1	common for relays: 1, 2, 3
S, M, L	J13-1	C4	common for relays: 4, 5, 6
	J13-2	NO4	normally open contact, relay no. 4
	J13-3	NO5	normally open contact, relay no. 5
	J13-4	NO6	normally open contact, relay no. 6
	J13-5	C4	common for relays: 4, 5, 6
	J14-1	C7	common for relay no. 7
	J14-2	NO7	normally open contact, relay no. 7/ normally open contact, relay no. 7 SSR 24 Vac/Vdc (*)
	J14-3	C7	common for relay no. 7
	J15-1	NO8	normally open contact, relay no. 8/ only S-board: normally open contact, relay no. 8 SSR 24 Vac/Vdc, S board only (*)
	J15-2	C8	common for relay no. 8
	J15-3	NC8/---	normally closed contact relay no. 8/ only S-board: not used, S board only (*)
	J16-1	C9	common for relay: 9, 10, 11
	J16-2	NO9	normally open contact, relay no. 9
	J16-3	NO10	normally open contact, relay no. 10
	J16-4	NO11	normally open contact, relay no. 11
	J16-5	C9	common for relay: 9, 10, 11
M, L	J17-1	NO12	normally open contact, relay no. 12/ normally open contact, relay no. 12 SSR 24 Vac/Vdc (*)
	J17-2	C12	common for relay no. 12
	J17-3	NC12/---	normally closed contact relay no. 12/ not used (*)
	J18-1	NO13	normally open contact, relay no. 13 / normally open contact, relay no. 13 SSR 24 Vac/Vdc (*)
	J18-2	C13	common for relay no. 13
	J18-3	NC13	normally closed contact relay no. 13 / not used (*)
	J19-1	ID15H	digital input no. 15, 230 Vac
	J19-2	ID15	digital input no. 15, 24 Vac/Vdc
	J19-3	IDC15	common for digital inputs 15 and 16 (negative pole for DC power supply)
	J19-4	ID16	digital input no. 16, 24 Vac/Vdc
L	J19-5	ID16H	digital input no. 16, 230 Vac
	J20-1	Y5	digital input no. 5 0...10 V
	J20-2	Y6	digital input no. 6 0...10 V
	J20-3	B9	passive analogue input 9 (NTC, PT1000, ON/OFF)
	J20-4	BC9	common for analogue input 9
	J20-5	B10	passive analogue input 10 (NTC, PT1000, ON/OFF)

Version	Connector	Signal	Description
	J20-6	BC10	common for analogue input 10
	J20-7	ID17	digital input no. 17, 24 Vac/Vdc
	J20-8	ID18	digital input no. 18, 24 Vac/Vdc
	J20-9	IDC17	common for digital inputs 17 and 18 (negative pole for DC power supply)
	J21-1	NO14	normally open contact, Relais no. 14/ normally open contact, Relais no. 14 SSR 24 Vac/Vdc (*)
	J21-2	C14	common for Relais no. 14
	J21-3	NC14/---	normally closed contact Relais no. 14/ not used (*)
	J21-4	NO15	normally open contact, Relais no. 15/ normally open contact, Relais no. 15 SSR 24 Vac/Vdc (*)
	J21-5	C15	common for Relais no. 15
	J21-6	NC15/---	normally closed contact Relais no. 15/ not used (*)
	J22-1	C16	common for Relais: no. 16, 17, 18
	J22-2	NO16	normally open contact, Relais no. 16
	J22-3	NO17	normally open contact, Relais no. 17
	J22-4	NO18	normally open contact, Relais no.18
	J22-5	C16	common for Relais: no. 16, 17, 18
	J23-1	E-	E- terminal for RS485 connection to the I/O expansion modules (not used)
	J23-2	E+	E+ terminal for RS485 connection to the I/O expansion modules (not used)
	J23-3	GND	GND terminal for RS485 connection to the I/O expansion modules (not used)
	J23-1	E-	E- terminal for RS485 connection to the I/O expansion modules (not used)
	J23-2	E+	E+ terminal for RS485 connection to the I/O expansion modules (not used)
	J23-3	GND	GND terminal for RS485 connection to the I/O expansion modules (not used)
	J24-1	+V term	additional power supply terminal Aria (not used)
	J24-2	GND	power supply common
	J24-3	+5 Vref	power supply for 0/5 V ratiometric probes
	J25-1	E-	E- terminal for RS485, BMS2 connection
	J25-2	E+	E+ terminal for RS485, BMS2 connection
	J25-3	GND	GND terminal for RS485, BMS2 connection
	J26-1	E-	E- terminal for RS485, FIELDBUS 2 connection
	J26-2	E+	E+ terminal for RS485, FIELDBUS 2 connection
	J26-3	GND	GND terminal for RS485, FIELDBUS 2 connection
	J27-1	1	ExV connection, stepper motor power supply
	J27-2	2	ExV connection, stepper motor power supply
	J27-3	3	ExV connection, stepper motor power supply
	J27-4	4	ExV connection, stepper motor power supply
	J28-1	1	ExV connection, stepper motor power supply
	J28-2	2	ExV connection, stepper motor power supply
	J28-3	3	ExV connection, stepper motor power supply
	J28-4	4	ExV connection, stepper motor power supply
	J29-1	GND	Earth for the signals
	J29-2	VREF	Active probe power supply
	J29-3	S1	Probe 1 (pressure) or external signal 4...20mA
	J29-4	S2	Probe 2 (temperature) or external signal 0...10V
	J29-5	S3	Probe 3 (pressure) or external signal 4...20mA
	J29-6	S4	Probe 4 (temperature)
	J29-7	DI1	Digital input 1
	J29-8	DI2	Digital input 2
	J30-1	VBAT	Emergency power supply
	J30-2	G0	Electrical power supply
	J30-3	G	Electrical power supply

(*) depending on model

Tab. 2.m

2.3 pRack pR300 S, M, D, L board dimensions

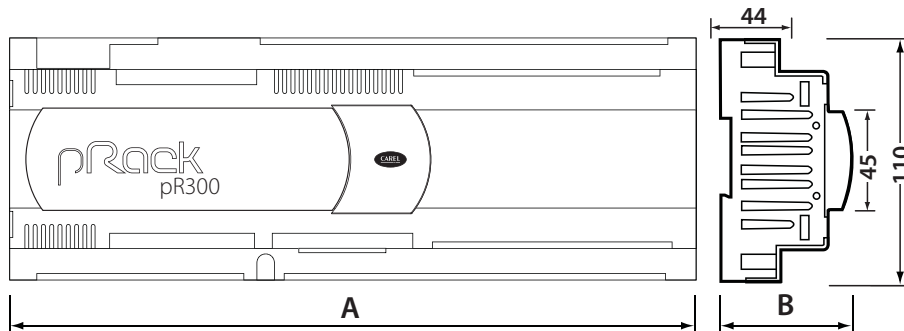

Fig. 2.e

	Small	Medium	Built-in driver	Large
A	227,5	315	315	315
B	60	60	60	60
B - with USB port and/or built-in terminal	70	70	70	70
B - with Ultracap module	-	-	75	-

Tab. 2.n

2.4 pRack pR300 general connection diagram

Small

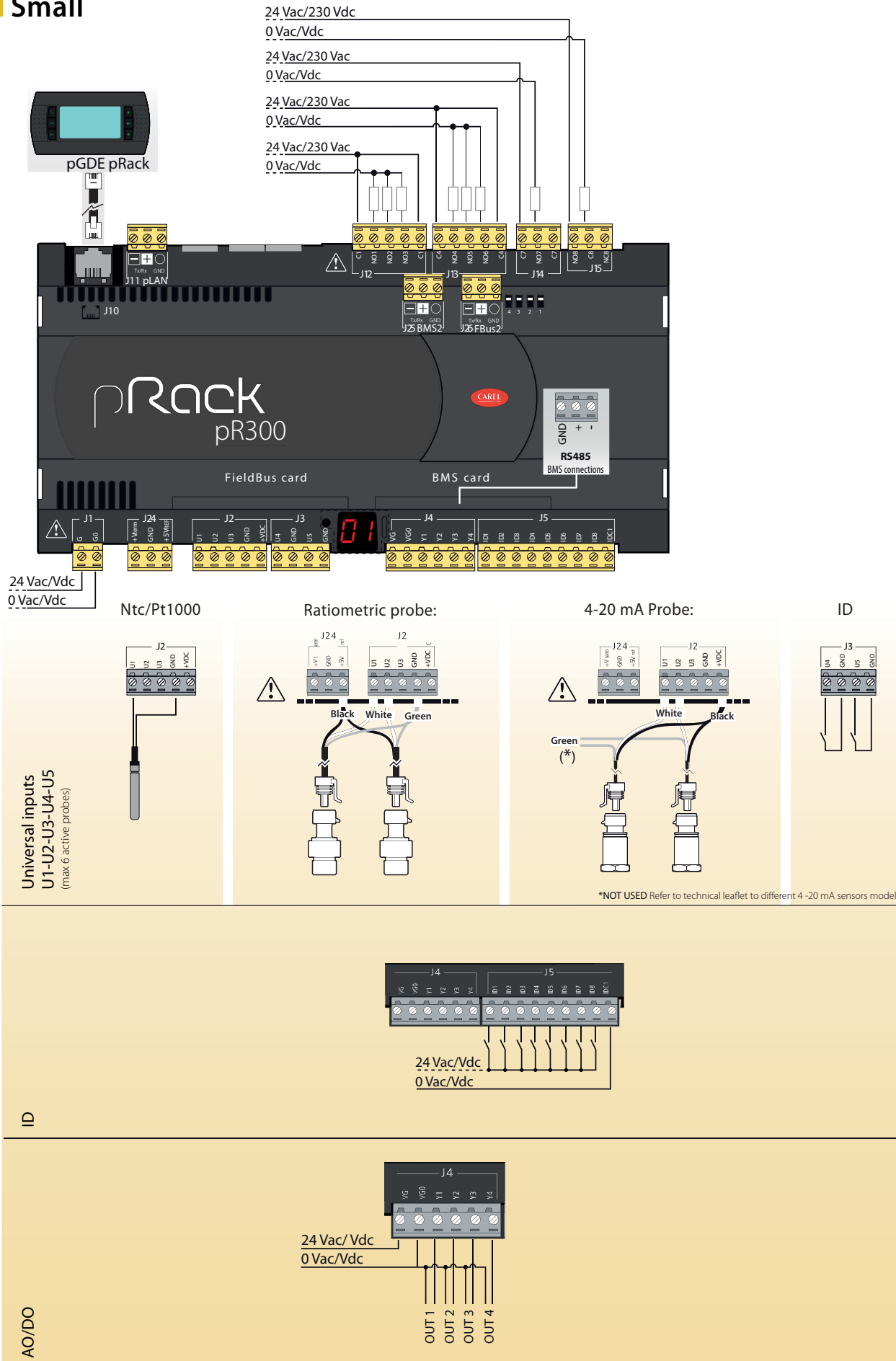

Medium

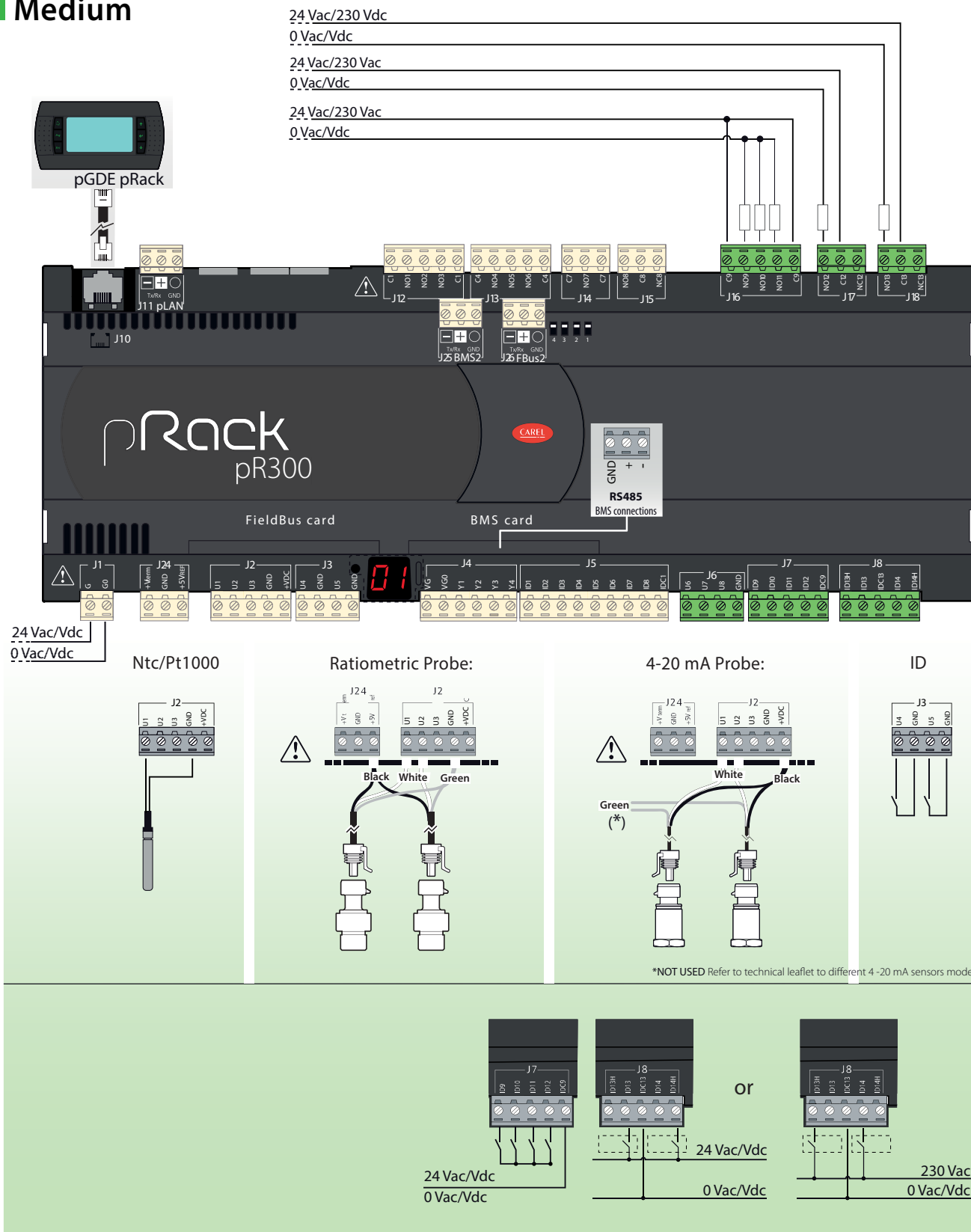

Large

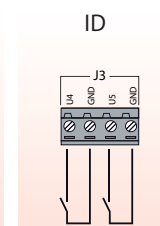
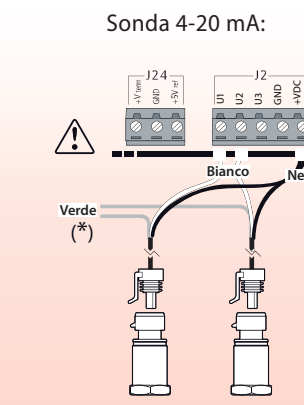
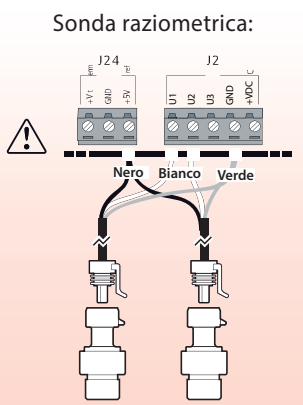
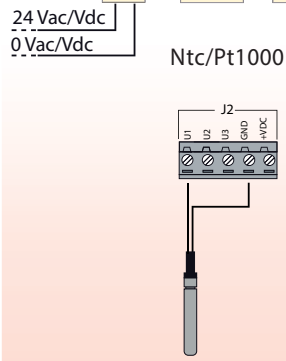
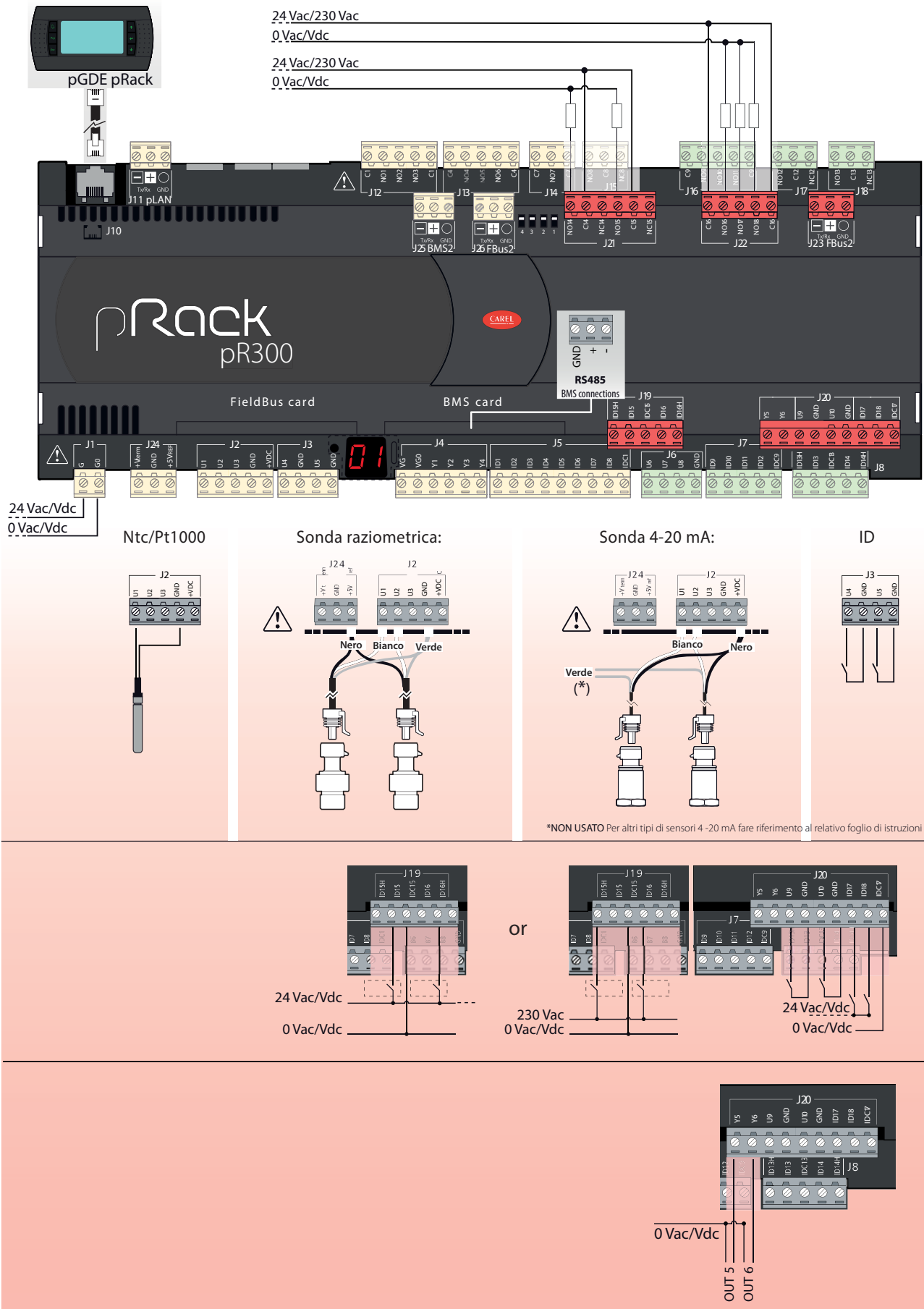

*NON USATO Per altri tipi di sensori 4-20 mA fare riferimento al relativo foglio di istruzioni

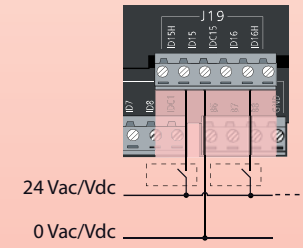

OR

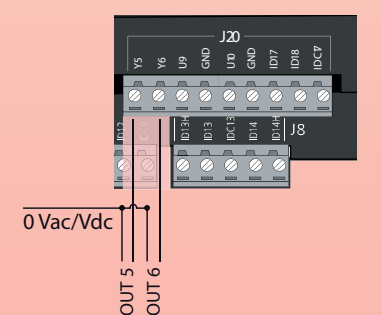
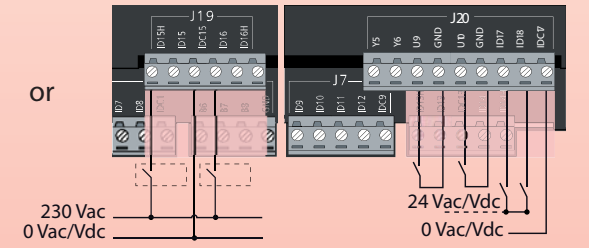

Built-in Driver

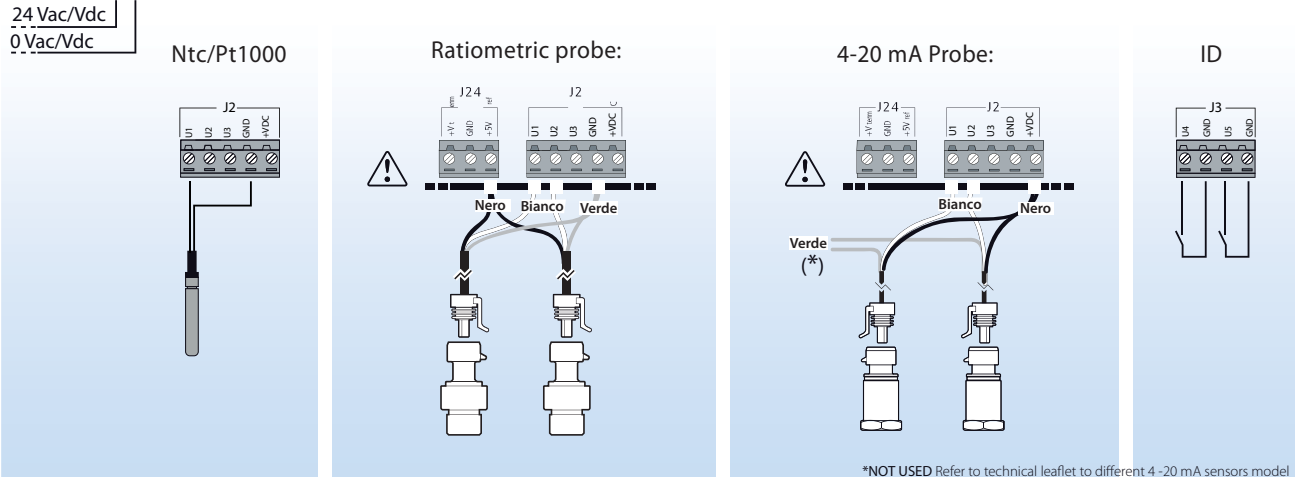
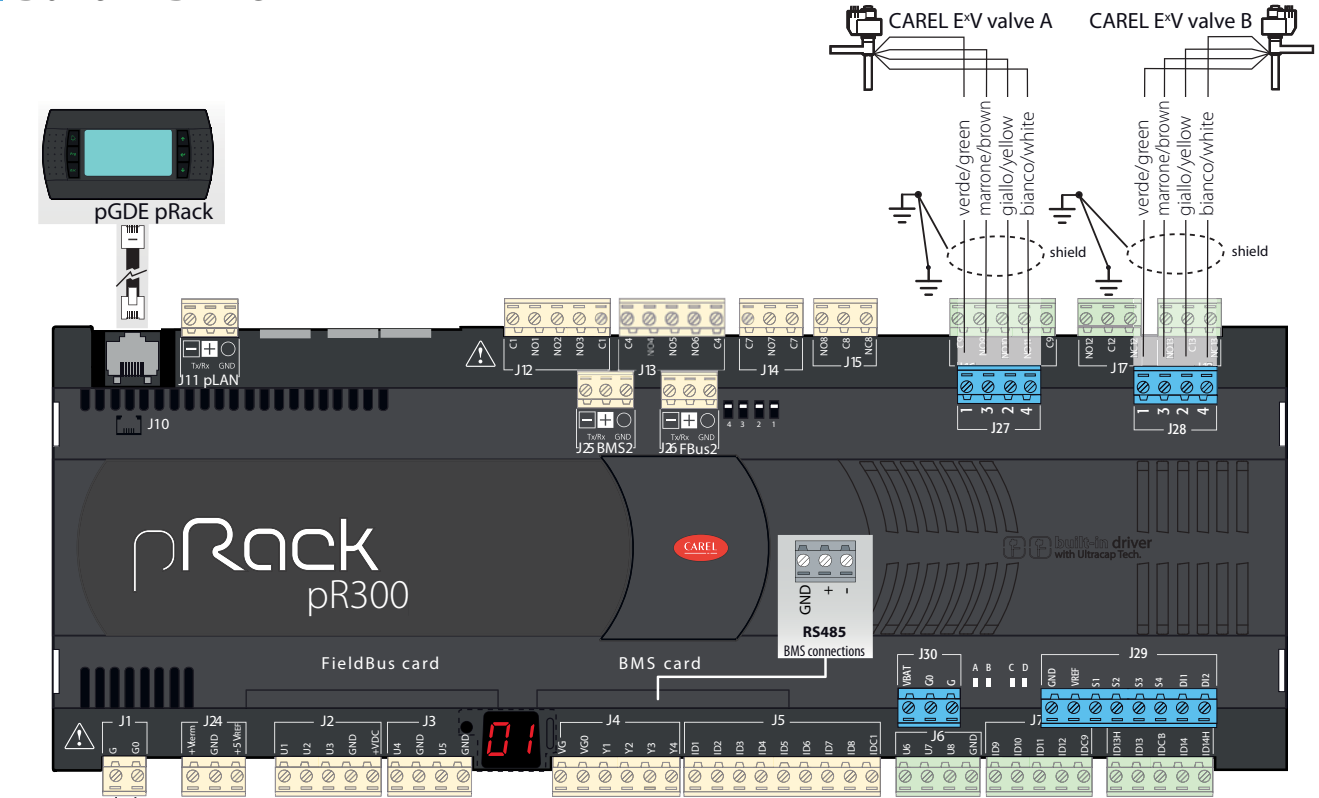

*NOT USED Refer to technical leaflet to different 4 -20 mA sensors model

Connection with other different valve model

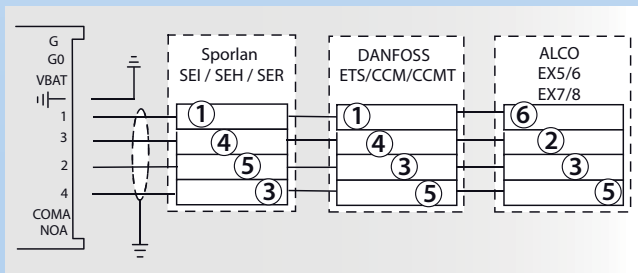

Key: 1 green 3 white 5 black
2 brown 4 red 6 blue

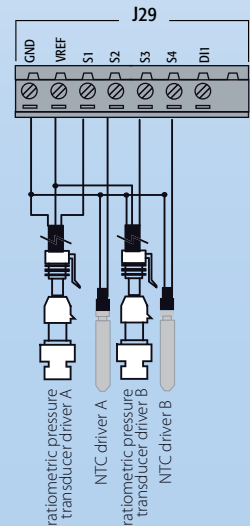

External Driver (suitable for S/M/L/D)

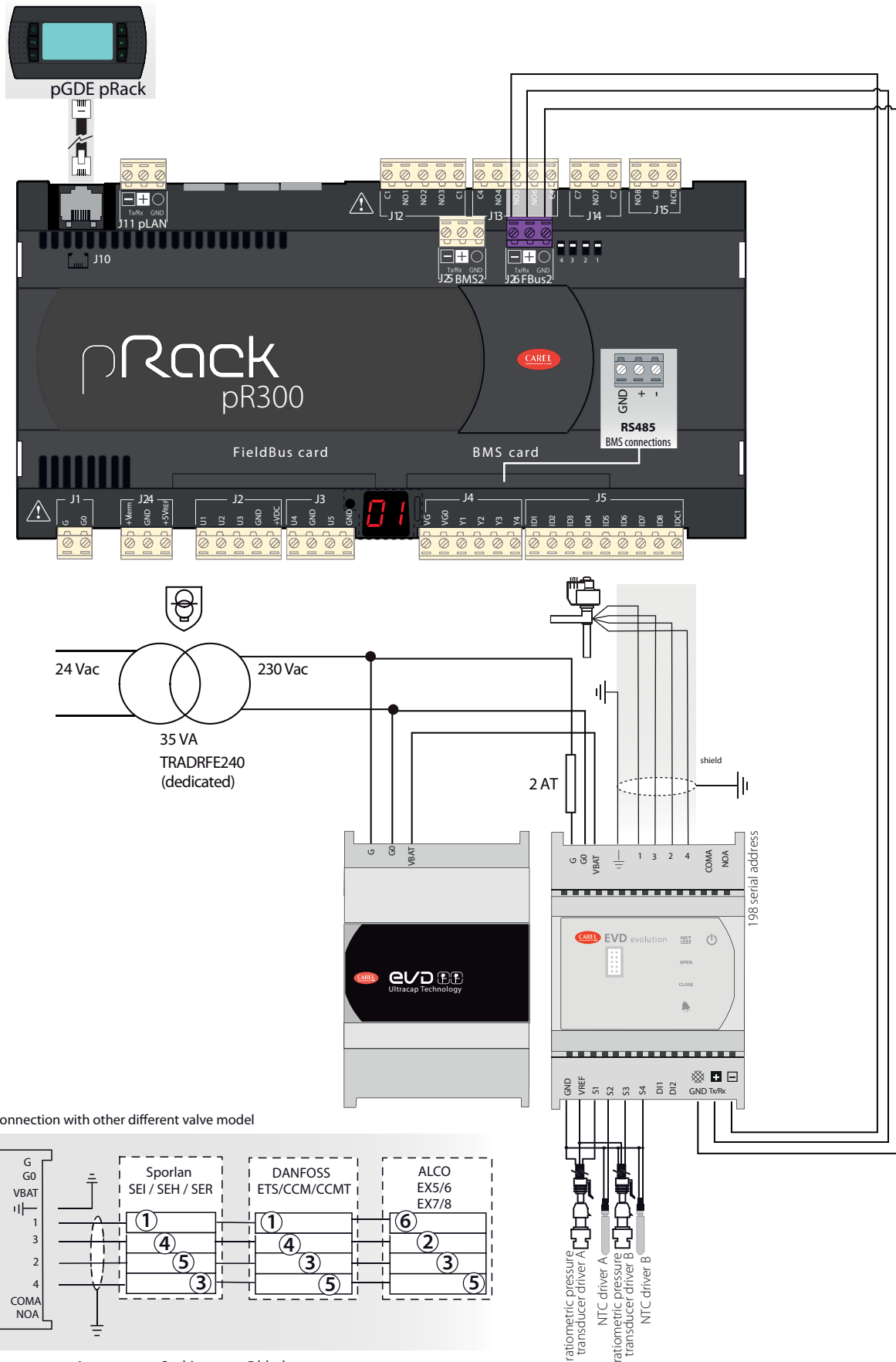

Key: 1 green 3 white 5 black
2 brown 4 red 6 blue

3. INSTALLATION

3.1 General installation instructions

3.1.1 Installation procedure

Environmental conditions

Avoid assembling the pRack pR300 and the terminal in environments with the following characteristics:

- temperature and humidity that do not conform to the rated operating data of the product;
- strong vibrations or knocks;
- exposure to aggressive and polluting atmospheres (e.g.: sulphur and ammonia fumes, saline mist, smoke) so as to avoid corrosion and/or oxidation;
- strong magnetic and/or radio frequency interference (therefore avoid installing the units near transmitting antennae);
- exposure of the pRack pR300 to direct sunlight and to the elements in general;
- large and rapid fluctuations in the room temperature;
- environments containing explosives or mixes of flammable gases;
- exposure to dust (formation of corrosive patina with possible oxidation and reduction of insulation).

Positioning the instrument inside the panel

The position of the instrument in the electrical cabinet must be chosen so as to guarantee correct physical separation of the instrument from the power components (solenoids, contactors, actuators, inverters, ...) and the connected cables. Proximity to such devices/cables may create random malfunctions that are not immediately evident. The structure of the panel must allow the correct flow of cooling air.

3.1.2 Wiring procedure

When laying the wiring, "physically" separate the power part from the control part. The proximity of these two sets of wires will, in most cases, cause problems of induced disturbance or, over time, malfunctions or damage to the components. The ideal solution is to house these two circuits in two separate cabinets. Sometimes this is not possible, and therefore the power part and the control part must be installed inside the same panel. For the control Signals, it is recommended to use shielded cables with twisted wires.

If the control cables have to cross over the power cables, the intersections must be as near as possible to 90 degrees, always avoiding running the control cables parallel to the power cables.

- Use cable ends suitable for the corresponding terminals. Loosen each screw and insert the cable ends, then tighten the screws. When the operation is completed, slightly tug the cables to check they are sufficiently tight;
- separate as much as possible the sensor Signal, digital input and serial line cables from the cables carrying inductive loads and power cables to avoid possible electromagnetic disturbance. Never insert power cables (including the electrical cables) and probe Signal cables in the same conduits. Do not install the sensor cables in the immediate vicinity of power devices (contactors, circuit breakers or similar);
- reduce the path of the sensor cables as much as possible, and avoid spiral paths that enclose power devices;
- avoid touching or nearly touching the electronic components fitted on the boards to avoid electrostatic discharges (extremely damaging) from the operator to the components;
- if the power transformer secondary is earthed, check that the earth wire corresponds to the wire that runs to the controller and enters terminal G0; this applies to all the devices connected to the pRack pR300;
- do not secure the cables to the terminals by pressing the screwdriver with excessive force, to avoid damaging the pRack pR300;
- for applications subject to considerable vibrations (1.5 mm pk-pk 10/55 Hz), secure the cables connected to the pRack pR300 around 3 cm from the connectors using clamps;
- if the product is installed in industrial environments (application of the EN 61000-6-2 standard) the length of the connections must be less than 30 m;
- all the very low voltage connections (analogue and 24 Vac/Vdc digital inputs, analogue outputs, serial bus connections, power supplies) must have reinforced or double insulation from the mains network;

- in residential environments, the connection cable between the pRack pR300 and the terminal must be shielded;
- there is no limit to the number of cables that can be connected to an individual terminal. The only limitation concerns the maximum current crossing each terminal: this must not exceed 8 A;
- the maximum cross-section of the cable that connected to a terminal is 2.5 mm² (12 AWG);
- the maximum value of the twisting torque to tighten the screw on the terminal (torque tightening) is 0.6 Nm;



Important:

- Installation must be performed according to the standards and legislation in force in the country where the device is used;
- for safety reasons the equipment must be housed inside an electrical panel, so that the only accessible part is the display and the keypad;
- in the event of malfunctions, do not attempt to repair the device, but rather contact the CAREL service centre;
- the connector kit also contains the stick-on labels.

3.1.3 Anchoring the pRack pR300

The pRack pR300 is installed on a DIN rail. To fasten the unit to the DIN rail, press it lightly against the rail. The rear tabs will click into place, locking the unit to the rail. Removing the unit is just as Simple, using a screwdriver through the release slot to lever and lift the tabs. The tabs are kept in the locked position by springs.

3.2 Power supply

Power supply to the pRack pR300 S, M; L (controller with terminal connected)	28...36 Vdc +10/-20% or 24 Vac +10/-15% 50...60 Hz; Maximum current P= 15 W (power supply Vdc), P=40 VA (Vac)
Power supply to the pRack pR300 Compact	DC power supply: 48 Vdc (36 Vmin...72 Vmax) AC power supply: 24 Vac +10/-15 %, 50/60 Hz Maximum current P=11W, P=14VA, Imax=700mA

Tab. 3.a



Important:

- power supplies other than those specified seriously damage the system;
- in the installation, it is recommended to supply just one pRack pR300 controller using a class 2 safety transformer - 100 VA for the models with built-in driver, and 50 VA for the pRack S, M, L models;
- the power supply to the pRack pR300 controller and terminal (or pRack pR300 controllers and terminals) should be separated from the power supply to the other electrical devices (contactors and other electromechanical components) inside the electrical panel;
- if the power transformer secondary is earthed, check that the earth wire corresponds to the wire that runs to the controller and enters terminal G0. This applies to all the devices connected to the pRack pR300;
- a yellow LED indicates that power is connected to the pRack pR300.

3.3 Universal inputs/outputs

Universal inputs/outputs are distinguished by the letter U...

They can be configured from the application program for many different uses, such as the following:

- passive temperature probes: NTC, PTC, PT100, PT500, PT1000;
- active pressure/temperature/humidity probes;
- ratiometric pressure probes;
- current inputs, 0 to 20 mA or 4 to 20 mA;
- voltage inputs, 0 to 1 Vdc or 0 to 10 Vdc;
- voltage-free contact digital inputs and fast digital inputs;
- analogue outputs, 0 to 10 Vdc;
- PWM outputs.



Important:

- the universal inputs/outputs cannot be used as digital outputs.

Max. number of connectable analogue inputs

The maximum number of analogue inputs that can be connected to the universal inputs/outputs depends on the type used.

		Max. number of inputs connectable to universal inputs/outputs		
		pCO5+		
Type of signal		Small	Medium/ Built-in driver/ Extralarge	Large
Analogue inputs	- NTC/PTC/PT500/PT1000 probes	5	8	10
	- PT100 probes	2	3 (2 on U1...U5, 1 on U6...U8)	4 (2 on U1...U5, 1 on U6...U8, 1 on U9...U10)
	- 0 to 1 Vdc/0 to 10 Vdc signals from controller-powered probes	Tot. max. 5	Tot. max. 8	Tot. max. 10
	- 0 to 1 Vdc/0 to 10 Vdc signals from externally powered probes	5	8	10
	- 0 to 20 mA/4 to 20 mA inputs from controller-powered probes	Tot. max. 4	6: (max 4 on U1...U5, 3 on U6...U8)	6: (max 4 su U1...U5, 3 on U6...U8, 2 on U9...U10)
	- 0 to 20 mA/4 to 20 mA inputs from externally powered probes	4	7: (max 4 on U1...U5, 3 on U6...U8)	9: (max 4 on U1...U5, 3 on U6...U8, 2 on U9...U10)
- 0 to 5 V signals from controller-powered ratiometric probes	5	6	6	

Tab. 3.a

Note: The table shows the maximum number of inputs that can be connected. For example, a Small controller can be connected to a maximum of five 0 to 1 Vdc inputs from controller-powered probes and a maximum of five 0 to 1 Vdc inputs from externally powered probes. In any case, the maximum number of inputs of both kinds that can be connected is 5.

3.3.1 Connecting universal NTC temperature sensors

For information on the maximum number of probes that can be connected see the table at the beginning of this paragraph.

The analogue inputs are compatible with 2-wire NTC sensors.

The inputs must be set for NTC Signals from the user terminal or using the default value installation procedure. The connection diagram is shown below:

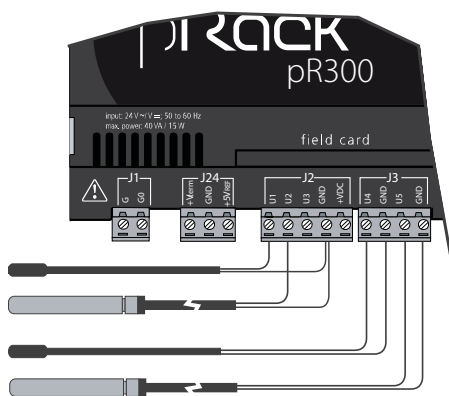

Fig. 3.a

Hardware Version	Terminals	NTC probe cable
S, M, D, L	GND	1
	U1...U10, S2, S4	2

Tab. 3.b

Note: the two wires of the NTC sensors are equivalent, as they have no polarity, therefore it is not necessary to follow any specific order when connecting to the terminal block.

3.3.2 Connecting PT1000 temperature sensors

For information on the maximum number of probes that can be connected see the table at the beginning of this paragraph.

The pRack pR300 can be connected to 2-wire PT1000 sensors for all high temperature applications; the operating range is: -100 to 200 °C.

The inputs must be pre-configured for PT1000 Signals from the user terminal or using the default value installation procedure.

The connection diagram is shown below:

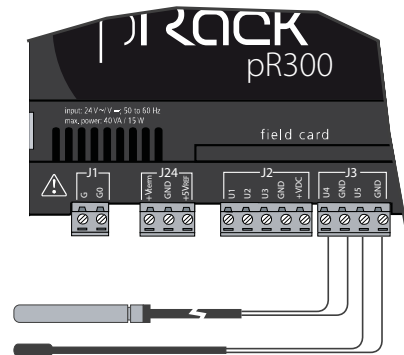

Fig. 3.b

Hardware Version	Terminals	PT1000 probe cable
S, M, D, L	GND	1
	U1...U10	2

Tab. 3.c

Important: for correct measurement by the PT1000 sensor, each sensor wire needs to be connected to a dedicated terminal, as shown in Fig. 3.b.

Note: the two wires of the PT1000 sensors are equivalent, as they have no polarity, therefore it is not necessary to follow any specific order when connecting to the terminal block.

3.3.3 Connecting current pressure probes

For information on the maximum number of probes that can be connected see the table at the beginning of this paragraph.

pRack pR300 can be connected to all CAREL SPK* series active pressure probes or any other pressure sensors available on the market with 0 to 20 mA or 4 to 20 mA Signal. The inputs must be set for 0 to 20 mA or 4 to 20 mA signals from the user terminal or using the default value installation procedure.

The connection diagram is shown below:

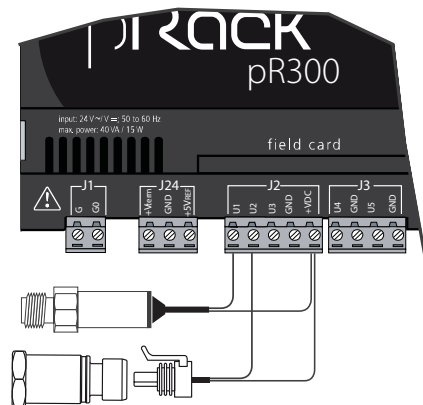

Fig. 3.c

Hardware Version	Terminals	Probe wire colour	Description
S, M, D, L	+VDC	brown	Power supply
	U1...U10, S1, S3	white	Signal

Tab. 3.d

Important: do not connect the green wire.

3.3.4 Connecting 0 to 5 V ratiometric pressure probes

For information on the maximum number of probes that can be connected see the table at the beginning of this paragraph. pRack pR300 can be connected to any other pressure probes available on the market with 0 to 5 V ratiometric sensor. The inputs must be set for 0 to 5 V Signals from the user terminal or using the default value installation procedure. The connection diagram is shown below:

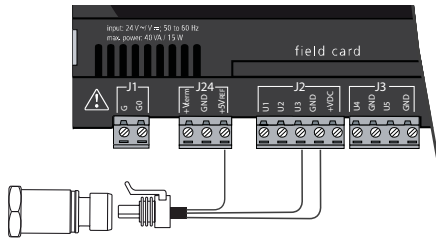

Fig. 3.d

Hardware Version	Terminals	Probe wire colour	Description
S, M, D, L	+5 V ref	black	power supply
	GND	green	power supply reference
	U1...U10, S1, S3	white	Signal

Tab. 3.e

3.3.5 Connecting 0 to 10 V active probes

For information on the maximum number of probes that can be connected see the table at the beginning of this paragraph. pRack pR300 can be connected to 0 to 10 V sensors. The inputs must be set for 0 to 10 V Signals from the user terminal or using the default value installation procedure. The connection diagram is shown below:

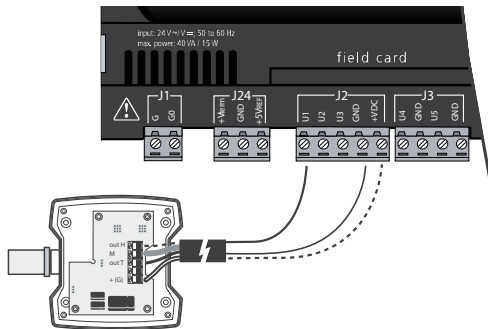

Fig. 3.e

Hardware Version	Terminals	Description
S, M, L, D	+VDC	power supply (any)
	GND	reference
	U1...U10	Signal

Tab. 3.f

3.3.6 Connecting analogue inputs selected as ON/OFF

For information on the maximum number of probes that can be connected see the table at the beginning of this paragraph. The pRack pR300 allows some analogue inputs to be configured as voltage-free digital inputs, not optically-isolated. The inputs must be pre-configured as voltage-free digital inputs from the user terminal or using the default value installation procedure.

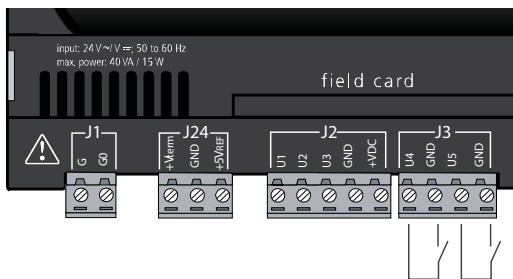

Fig. 3.f

Hardware Version	Terminals	Digital input cable
S, M, D, L	GND	1
	U1...U10	2

Tab. 3.g

! Important:

- the maximum current available at the digital input is 5 mA (thus the rating of the external contact must be at least 5 mA).
- these inputs are not optically-isolated.

3.3.7 Remote connection of the analogue inputs

The Sizes of the cables for the remote connection of the analogue inputs are shown in the following table:

Type of input	Size [mm ²] for length up to 50 m	Size [mm ²] for length up to 100 m
NTC	0.5	1.0
PT1000	0.75	1.5
current	0.25	0.5
voltage	0.25	0.5

Tab. 3.h

If the product is installed in industrial environment (in compliance for the EN 61000-6-2 standard) the length of the connections must be less than 30m. In any case you should never exceed this length to have no measurement errors.

3.4 Connecting the digital inputs

The pRack pR300 features digital inputs for connecting safety devices, alarms, device status and remote switches. These inputs are all optically isolated from the other terminals at 24 Vac, 24 Vdc and some at 230 Vac for M, D, L models.



Note: separate the sensor Signal and digital input cables as much as possible from the inductive load and power cables, to avoid possible electromagnetic disturbance.

! Important:

- if the control voltage is drawn in parallel with a coil, fit a dedicated RC filter in parallel with the coil (the typical ratings are 100 Ω, 0.5 μF, 630 V).
- If connecting the digital inputs to safety systems (alarms), remember that: the presence of voltage across the contact must be the normal operating condition, while no voltage must represent an alarm situation. This will ensure that any interruption (or disconnection) of the input will also be Signalled. Do not connect the neutral in place of an open digital input. Always interrupt the phase. The 24 Vac/Vdc digital inputs have a Resistance of around 5 kΩ.

All pRack digital inputs can be powered at 24 Vac and 24 Vdc, while for models M, D, L only 230 Vac inputs are also available. To maintain the optical isolation of the digital inputs, a separate power supply must be used just for the digital inputs. The connection diagrams shown in these figures, which while being the more common and the more convenient, do not exclude the possibility of powering the digital inputs independently from the power supply to the pRack pR300. In any case, the inputs only have functional insulation from the rest of the controller.

24 Vac digital inputs

The following figure represents an example for connecting the 24 Vac digital inputs on pRack models S, M, L.

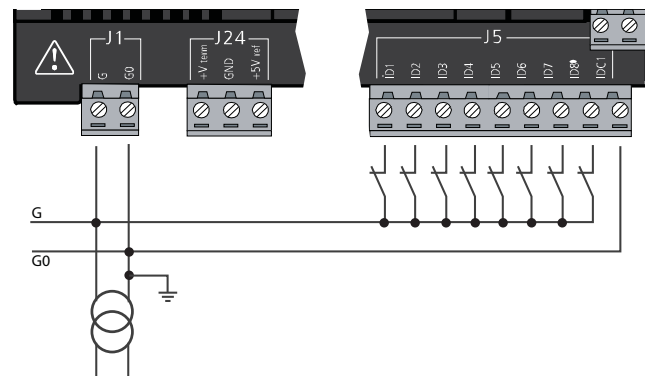

Fig. 3.g

24 Vdc digital inputs

The following figure represents an example for connecting the 24 Vdc digital inputs on pRack models S, M, L.

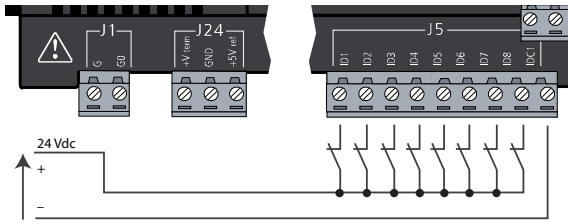

Fig. 3.h

230 Vac digital inputs

pRack M, D, L models have up to two groups of inputs powered at 230 Vac 50/60 Hz +10/-15%; each group features two inputs. The groups have double insulation between them and can have different voltages.

Important: within each group the inputs must be powered at the same voltage to avoid short-circuits or powering lower voltage inputs at 230 Vac.

The range of uncertainty of the switching threshold is from 43 to 90 Vac. It is recommended to use a 100 mA fuse in series with the digital inputs. The following figure represents an example for connecting the 230 Vac digital inputs on pRack models M, D, L.

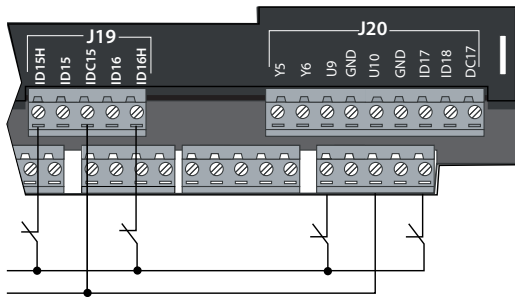

Fig. 3.i

3.4.8 Remote connection of the digital inputs

Important note: do not connect other devices to the digital inputs IDn inputs.

The Sizes of the cables for the remote connection of the digital inputs are shown in the following table:

Size (mm ²) for length up to 50 m	Size (mm ²) for length until 100 m
0,25	0,5

If the product is installed in industrial environments (application of the EN 61000-6-2 standard) the length of the connections must be less than 30 m. This length shouldn't be exceeded in any case, to avoid measurement errors.

3.5 Connecting the analogue outputs

3.5.1 Connecting 0...10 V analogue outputs

The pRack pR300 provides 0...10 V optically-isolated analogue outputs, powered externally at 24 Vac/Vdc.

The figure below shows the electrical connection diagram; the 0V (zero) of the power supply is also the reference for the output voltage:

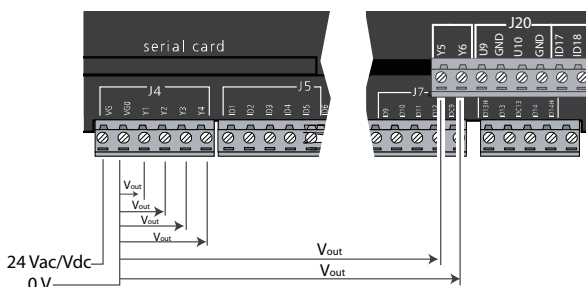

Fig. 3.j

Hardware Version	Terminals	Reference
S, M, D	Y1, Y2, Y3, Y4	VG0
L	Y1, Y2, Y3, Y4, Y5, Y6	VG0

Tab. 3.i

3.5.2 Optional modules

Module for converting a PWM analogue output to a liner 0...10 V and 4...20 mA analogue output (code CONV0/10A0)

The module is used to convert a PWM output (5 V pulses) to a liner 0...10 V and 4...20 mA analogue output (code CONV0/10A0). The control Signal (at the input terminals optically-isolated from the rest of the module) must have a maximum amplitude of 5V and a period between 8 ms and 200 ms. The 0...10 V output voltage can be connected to a maximum load of 2 kΩ, with a maximum ripple of 100 mV. The 4...20 mA current output can be connected to a maximum load of 280 Ω, with maximum overshoot of 0.3 mA. The mechanical dimensions of the module are 87x36x60 mm (2 DIN modules) with IP20 index of protection.

Module for converting a 0...10 V analogue output to an SPDT digital output (code CONVONOFF0)

The module is used to convert a 0...10V analogue output to an ON/OFF relay output. The control Signal (at the input terminals, optically-isolated from the rest of the module), to ensure the switching of the relay from OFF to ON, must have a maximum amplitude of 3.3 V. The relay is SPDT, with max current of 10 A and max inductive load of 1/3 HP. The mechanical dimensions of the module are 87x36x60 mm (2 DIN modules) with IP20 index of protection.

3.6 Connecting the digital outputs

3.6.1 Electromechanical relay digital outputs

The pRack pR300 features digital outputs with electromechanical relays. For ease of installation, the common terminals of some of the relays have been grouped together.

The following figure illustrates a connection example. If the following this diagram is used, the current at the common terminals must not exceed the rating (nominal current) of a single terminal (8 A).

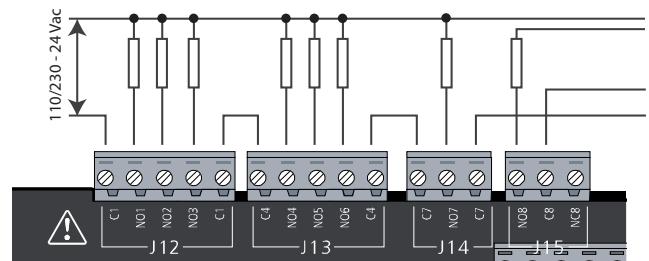

Fig. 3.k

The relays are divided into groups, according to the degree of insulation. Inside each group, the relays have just basic insulation and thus must have the same voltage (generally 24V ac or 110 to 230 Vac). Between the groups there is double insulation and thus the groups can have different voltages. There is also double insulation from the rest of the controller.

Changeover outputs

Some relays feature changeover outputs, the number of changeover outputs depends on whether or not there are solid state relays (SSR) and consequently varies depending on the models.

Hardware version	Changeover relay reference, without SSR model	Terminal
PRK300**F* models		
S	8	J15
M, D	8, 12, 13	J15, J17, J18
L	8, 12, 13, 14, 15	J15, J17, J18, J21

Tab. 3.j

3.6.2 Solid state relay (SSR) digital outputs

The pRack pR300 also features a Version with solid state relays (SSR) on some models for controlling devices that require an unlimited number of switching cycles and thus would not be supported by electromechanical relays (e.g. screw compressor valves). They are dedicated to loads powered at 24 Vac/Vdc with a maximum power Pmax = 10 W.

! Important: the SSRs can control resistive loads powered at 24 Vac/Vdc, maximum power $P_{max} = 10$ W. For details see paragraph 2.2.8. The figure shows a connection example for resistive loads.

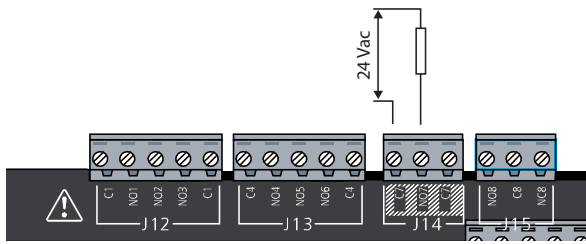

Fig. 3.1

The following figure illustrates correct applications for inductive loads.

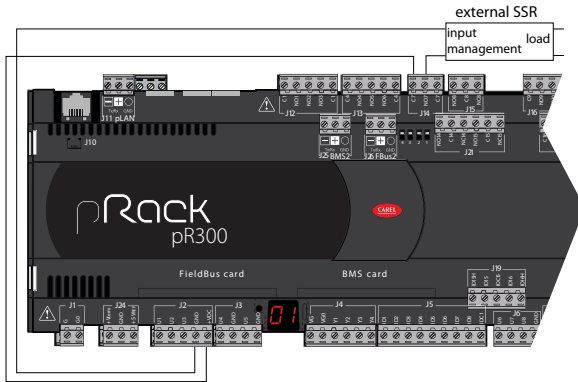

Fig. 3.m

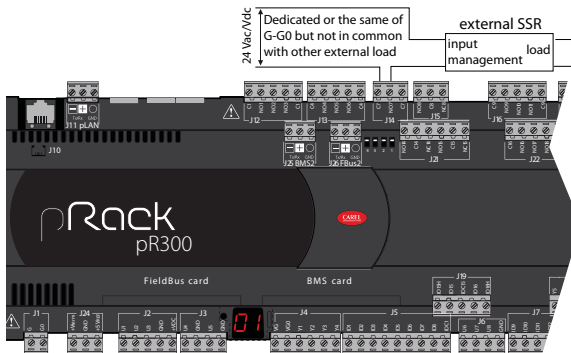

Fig. 3.n

The table below shows the reference outputs for pRack models fitted with SSR outputs.

Hardware version	Reference relay SSR	Terminal
S	7, 8	J14, J15
M, D	7, 12	J14, J17
L	7, 8, 12, 13, 14, 15	J14, J15, J17, J18, J21

Tab. 3.k

! Important: the SSR relay load is powered at 24 Vac/Vdc, thus all the other terminals in the group must be powered at 24 Vac/Vdc due to the absence of double insulation within the group.

3.6.3 Summary table of digital outputs according to the Versions available

Hardware version	NO contacts	NC contacts	Changeover contact	n.ro outputs	relay in SSR
PRK300**E* Models					
S	6	-	-	8	2 (7, 8)
M, D	9	-	2 (8, 13)	13	2 (7, 12)
L	12	-	-	18	6 (7, 12, 13, 14, 15)
PRK300**F* Models					
S	7	-	1 (8)	8	-
M, D	10	-	3 (8, 12, 13)	13	-
L	13	-	5 (8, 12, 13, 14, 15)	18	-

Tab. 3.l

3.6.4 Remote connection of the digital outputs

The Sizes of the cables for the remote connection of the digital outputs are shown in the following table:

AWG	Size [mm ²]	Current [A]
20	0,5	2 A
15	1,5	6 A
14	2,5	8 A

Tab. 3.m

If the product is installed in industrial environments (application of the EN 61000-6-2 standard) the length of the connections must be less than 30 m. This length shouldn't be exceeded in any case.

3.7 pLAN electrical connections

If the selected system configuration involves the connection of more than one pRack pR300 board in a pLAN, AWG20/22 twisted pair shielded cable must be used, with capacitance between the wires less than 90 PF/m. The maximum length of the pLAN network is 500 m with AWG22 twisted pair shielded cable.

The boards should be connected in parallel with reference to plug-in connector J5 (pRack Compact) or J11 (versions S, M, L).

! Important: follow the network polarity: RX/TX+ on one board must be connected to RX/TX+ on the other boards; the same applies to RX/TX-.

The figure shows the diagram for more than one board connected in a pLAN network; this is a typical application with more than one board connected inside the same electrical panel.

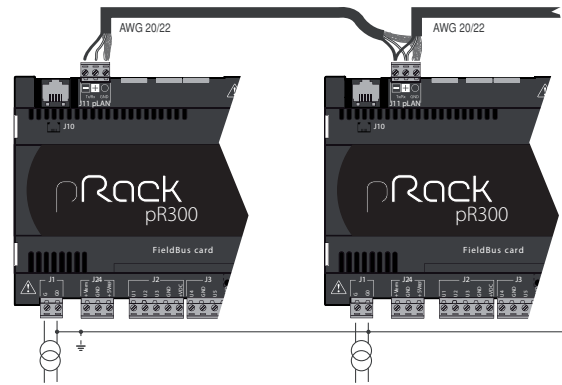

Fig. 3.a

! Important: pLAN connections are possible in which more than one board is powered by different transformers; for further details see pRack system general manual: +030220335.

3.7.1 Connecting the terminals

pRack pR300 uses PGD1 terminals, either built-in or external connected via pLAN. Up to 2 external terminals can be connected, with pLAN addresses 31 and 32.

The connection can be made using 6-wire telephone cables (connector J4 for Compact models or J10 for S, M, L) or shielded twisted pair cables with 3-pin plug-in connectors (connector J5 for Compact models or J11 for S, M, L), as shown in the table

Cable type	Power supply distance	Power supply
6-pin phone (J10)	10 m	Taken from pRack (150 mA)
AWG24	200 m	Taken from pRack (150 mA)
AWG20/22	500 m	Separate, via TCONN6J000

Tab. 3.n

For further details on connecting the terminals, see the pRack system general manual: +030220335.

4. START UP

4.1 Starting the first time

After having correctly installed pRack, a number of preliminary operations are required to configure the installation.

Tutorial: the pRack pR300 configuration procedure varies according to the complexity of the installation:

- A. **systems with only one board and maximum one external terminal.** In this case, simply connect the terminal (if not built-in), power up the board and select one of the configuration solutions described below.
- B. **systems with more than one board in pLAN or two external terminals.** In this case, the additional operations described in Appendix A. 2 need to be completed before proceeding with configuration.

The procedure for configuring an installation described below is the same for all system configurations that feature just one pRack pR300 board, and for system configurations with more than one board connected in a pLAN.

When first starting the pRack pR300 board, after waiting around 1 minute, a screen is shown for choosing the language used to display the program (English or Italian).

Press ENTER (↵) to change the language displayed, while pressing ESC displays the following screen.

Note:

- If no option is chosen within a time set by parameter and visible on the screen, the current language remains selected.
- pRack pR300 is available as standard with English and Italian languages loaded on board. Other languages are available at ksa.carel.com that can be loaded onto the control using the pRack Manager software, following the procedure described in Chap. 10.

After having selected the user interface language, the pRack pR300 software shows a screen for choosing between three possible system configuration solutions, as follows:

- Pre-configurations
- Wizard
- Advanced configuration.

Important:

- after having configured the system, the configuration can be modified, it can be modified by repeating the same procedure, making sure the Carel default values have been reset as described in paragraph 6.8.2.
- after having configured the system, power down the controller and power up again.

Summary of pre-configurations

N°	index	lines	compressors				fans			Units in the pLAN(as well as the terminal)	pRack pR300 Version
			type	N°	capacity step	modulation	No. of comp. alarms	N°	inverter		
1	RS2	1	Piston - Scroll	2	-	-	1	2	-	1	Small
2	RS3	1	Piston - Scroll	3	-	-	1	3	-	1	Small
3	RS3p	1	Piston - Scroll	3	1	-	2	1	Inverter	1	Medium
4	RS3i	1	Piston - Scroll	3	-	Inverter	3	1	Inverter	1	Medium
5	RS4	1	Piston - Scroll	4	-	-	2	4	-	1	Medium
6	RS4i	1	Piston - Scroll	4	-	Inverter	3	1	Inverter	1	Large
7	SL3d	1	Scroll	3	-	Digital	1	2	-	1	Medium
8	SL5d	1	Scroll	5	-	Digital	1	1	Inverter	1	Medium
9	SW1	1	Screw	1	2	-	2	2	-	1	Small
10	SW2	1	Vite	2	2	-	2	1	Inverter	1	Small
11	d-RS2	2	Pistoni - Scroll	2	-	-	1	2	-	1	Medium
				2	-	-	1				
12	d-RS3	2	Pistoni - Scroll	3	-	-	1	3	-	1	Large
				3	-	-	1	3	-		
13	d-RS4	2	Pistoni - Scroll	4	-	Inverter	3	1	Inverter	1,2	Medium + Medium
				4	-	Inverter	3	1	Inverter		

Tab. 4.a

(*) configuration not available in versions 1.0 and 1.1 of the pRack software.

4.1.1 Pre-configurations

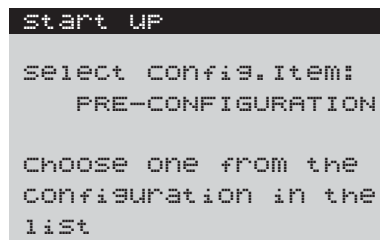

Fig. 4.a

This solution is used to choose between fourteen configurations pre-loaded in the pRack pR300 software. For the description of the pre-configurations see the table below, while for the complete description of each configuration see Appendix A1.

pRack pR300 automatically configures the inputs and outputs as described in paragraph 4.1.4; for details on the inputs and outputs associated with each pre-configuration, see the quick guide code +040000070.

4.1.2 Wizard

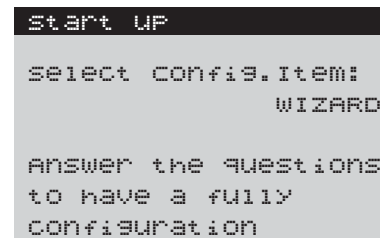

Fig. 4.b

This solution is used to obtain the recommended configuration for the specific installation. By responding to a series of questions, screen by screen, the user is guided through the selection of the devices present.

Once the guided selection procedure has been completed, the end result (report) is shown, and if the configuration is suitable the parameters to start operation of the pRack pR300 can be installed directly, including those associated with the inputs and outputs as described in parag. 4.1.4.

Note: after having configured the parameters using the Wizard, the configuration can be modified manually, within the context of the selected system configuration.

Important: before starting the pRack pR300, carefully check the settings made automatically by the software.

Tutorial: Appendix A.3 shows a configuration example using the Wizard for an installation with two suction lines.

4.1.3 Advanced configuration

```

Start UP

Select Config.Item:
ADVANCED CONFIGURATION

It ONLY defines the
STRUCTURE OF THE PLANT
FOR VERY EXPERT USERS

```

This solution is used to establish the configuration of the pLAN structure required for correct system operation.

Once the procedure for selecting the various factors that affect the final configuration has been completed, the pRack pR300 software verifies whether the pLAN configuration is exact and prepares the user interface for configuration of the parameters that need to be set manually by the user.

 **Important:** this configuration solution is only recommended for expert users, as all the system parameters need to be set manually.

4.1.4 Associating the inputs and outputs

When using pre-configurations and the wizard, pRack pR300 can automatically associate the board's inputs and outputs with the various functions.

For the wizard only, after having configured the lines, automatic association can be chosen as an option. If choosing not to use this function, the I/Os need to be configured manually, according to requirements.

The criteria applied for automatic association are described below.

Digital outputs

pRack pR300 assigns in order:

- Compressor outputs: first the SSR outputs for screw or Digital Scroll™ then the starting outputs, the capacity control valves and the inverter, if present
- Fan outputs
- Global alarm.

Digital inputs

pRack pR300 assigns in order:

- High and low pressure switches (HP and LP)
- Compressor alarms
- Fan alarms



Note: pRack pR300 can also use certain analogue inputs as digital inputs, nonetheless the common HP and LP pressure switches are always associated with actual digital inputs.

Analogue inputs

pRack pR300 assigns in order:

- Pressure or temperature control probes for 1 or 2 lines, according to the settings made. The types of probe assigned as default are 4...20 mA or 0 to 5 V (first 4...20 mA, then 0 to 5 V if necessary) for the pressure probes, NTC for the suction temperature probes and HTNTC for the condensing temperature probes;
- Suction temperature probe on line 1: if possible this is associated with input B3, otherwise the first free input;
- Discharge temperature probe on line 1;
- Suction temperature probe on line 2;
- Discharge temperature probe on line 2.

Analogue outputs

pRack pR300 assigns in order:

- Compressor inverters for 1 or 2 lines;
- Fan modulating devices for 1 or 2 lines.

5. USER INTERFACE

5.1 Graphic terminal

The pRack pR300 user interface is represented by the pGD1 terminal, panel or built-in versions.

The functions associated with the 6 buttons on the pGD1 terminal are the same on all the screens and are described in the table below.

Functions of the 6 buttons

Button	Function associated
(ALARM)	displays the list of active alarms and accesses the alarm log
	used to enter the main menu tree
	returns to the higher level screen
(UP)	scrolls a list upwards or increases the value highlighted by the cursor
(DOWN)	scrolls a list downwards or decreases the value highlighted by the cursor
(ENTER)	enters the selected submenu or confirms the set value.

Tab. 5.a

The LEDs associated with the buttons have the following meanings.

Meaning of LEDs

LED	Button	Meaning
Red		Flashing: active alarms present and not acknowledged Steady: alarms present and acknowledged
Yellow		pRack pR300 on
Green		pRack pR300 powered

Tab. 5.b

5.2 Description of the display

There are three fundamental types of screens shown to the user:

- Main screen
- Customised main screen
- Menu screen
- Screen for displaying/setting the parameters

Main screen

The main screen is the screen that the software on board pRack pR300 automatically returns to 5 minutes after the last button was pressed.

An example of the main screen is shown in the figure, highlighting the fields and icons used:

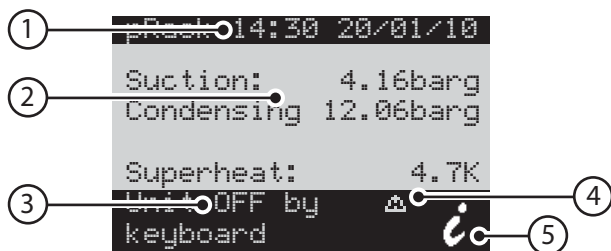

Fig. 5.a

1	Time and date
2	Main values.
3	Unit status (unit off) or compressor and fan status (unit on)
4	Active alarm Signal and manual operation
5	Access further information screens (menu branch A.a) by pressing button

Note:

- the information shown on the main screen varies according to the system configuration (one line, two lines with shared condenser) and the type of control value used (pressure or temperature). For two line systems, a parameter is used to select which line is shown first.

- the other information shown in menu branch A.a. varies according to the system configuration. For two line systems, pressing from the main screen accesses a different screen based on the starting point (line 1, line 2).

Customised main screen

pRack pR300 offers the possibility to configure the information displayed on the main screen and the second screen (pressing DOWN) as desired. For example, information on specific probes with physical readings (pressure or temperature), no longer grouped by screen but rather customised row-by-row on the display. The basic structure comprises two screens that are scrolled by pressing Up and Down; all the information can be configured for display on the main screen relating to pressure or temperature, the characteristic that is not selected will then be displayed on the secondary screen, only if significant.

Main screen



Secondary screen

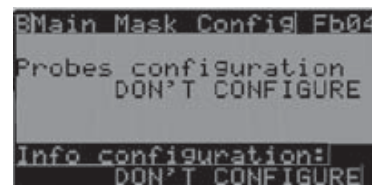

Fig. 5.d

In the example, a suction line with control by pressure has been configured, the main screen displays the values read by the suction and condensing pressure probes, while the superheat is displayed in degrees centigrade; the secondary screen will show the converted temperatures of the suction and condensing pressure probe readings, together with the description of superheat by pressure, which is not displayed as this information would not be significant. By default the main screen will continue to show the same information as always displayed on the pR100 (depending on the type of configuration: SUCTION&CONDENSER, rather than SUCTION and the type of control PRESSURE/TEMPERATURE).

When starting the first time, the main screen will reflect the settings made. Custom configuration of the main screen is then performed subsequently, as described below:

The configuration is made under Settings -> Language in screen Fb04



On this screen, users can choose whether to configure the part relating to the probes, or the bottom bar with the percentages or number of active peripherals in the circuit. On screen Fb04, go to the field underneath "Probe configuration", change the value to "CONFIGURE" and press Enter. The following screen (Fb05) is displayed, which shows the layout of the main screen with the modifiable fields for each row. The following options are available:

Probe	Description
Suction	Suction used for single suction line
Condenser	Condenser used for single condenser line
Superheat	Superheat used for single suction line
L1 - Suction	Suction on line 1
L2 - Suction	Suction on line 2
L1 - Condenser	Condenser on line 1
L2 - Condenser	Condenser on line 2
Suction temperature	Suction temperature for single suction line
L1 - Suction temperature	Suction temperature on line 1
L2 - Suction temperature	Suction temperature on line 2
Discharge temperature	Discharge temperature for single suction line
L1 - Discharge temperature	Discharge temperature on line 1
L2 - Discharge temperature	Discharge temperature on line 2
Auxiliary	Auxiliary probe for single suction line
L1 - Auxiliary	Auxiliary probe on line 1
L2 - Auxiliary	Auxiliary probe on line 2
L1 - Superheat	Superheat on line 1
L2 - Superheat	Superheat on line 2
EVD1 - Condenser	Condenser line 2 connected to driver 1
EVD2 - Condenser	Condenser line 2 connected to driver 2

Tab. 5.c

After having configured the required information, choose the characteristic to be displayed on the main screen, Pressure or Temperature.

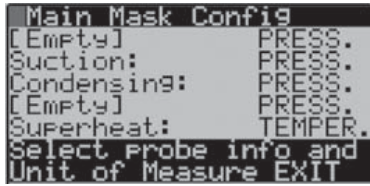

To exit this screen, simply press Esc and return to the Language menu.

Information on bottom bar:

In screen Fb04, go on the field underneath the description "Info configuration", change the value to "CONFIGURE" and press Enter. The bottom bar can display information relating to a single line or double line; for single line, select whether to display L1 or L2.

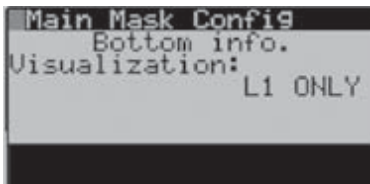

Single line configuration

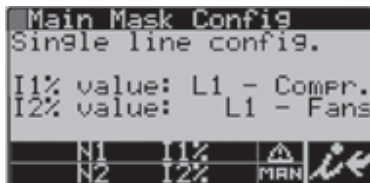
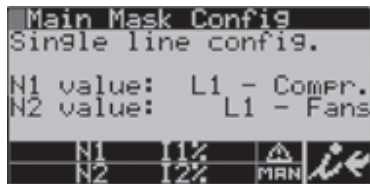

As can be seen in the figure, the bottom part of the screen displays 2 integer values (N1 and N2) and 2 percentages; the icons shown will depend on the selected information.

Value	Description Nx	Description Ix%	Icon
L1 - Compressors	Number of active compressors on L1	Active compressor capacity as % on L1	L1 [C]
L2 - Compressors	Number of active compressors on L2	Active compressor capacity as % on L2	L2 [C]
L1 - Fans	Number of active fans on L1	Active fan power as % on L1	L1 [F]
L2 - Fans	Number of active fans on L2	Active fan power as % L1	L2 [F]
L1 - Valves	Number of active compressors on L1 that control EVS valves	Percentage of valve capacity request from L1	[V]
L2 - Valves	Number of active compressors on L2 that control EVS valves	Percentage of valve capacity request from L2	[V]

Double line configuration

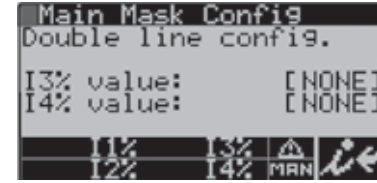
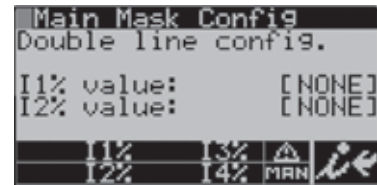

In configurations that feature control of two suction lines, 4 different percentages can be shown from the values described in the previous table. The customised main screen is simply an option that is available following configuration of the main screen in the Wizard.

Menu screen

An example of a menu screen is shown in the figure below:

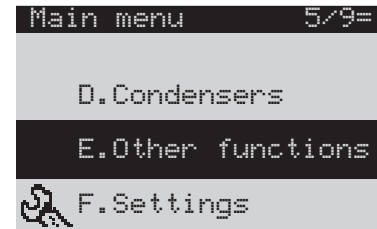

The top right corner shows the selected item and the current password level (for details see the following paragraph). The ↑ and ↓ buttons are used to select the desired menu item, while ← accesses the selected item.

Screen for displaying/setting the parameters

An example of a screen for displaying/setting the parameters is shown in the figure, also highlighting the fields and icons used:



Fig. 5.b



- 1 | Menu branch identifier
- 2 | Screen identifier
- 3 | Parameter

The screen identifier uniquely identifies the menu branch and the screen: the first characters indicate the menu branch, while the last two alphanumeric digits identify the order of the screen inside the menu, for example screen Bab01 is the first screen in menu B.a.b.

Note: The information on the screens may vary according to the password level used to access the menu.

5.3 Password



pRack pR300 manages three levels of password:

-  User
-  Maintenance
-  Manufacturer

Each level includes the same rights as the lower levels, that is, the Manufacturer can access all the screens and parameters, the Maintenance can access the screens and parameters available in the Maintenance and User levels, while the User can only access the screens and parameters available in the User level.

 Note: All levels display the main screens and the other information screens.

When pressing  a prompt is shown to enter the password, which remains active for 5 minutes after the last button is pressed.

The menu screens show their own password level using an icon at the top right:  1 line: user,  2 lines: maintenance,  3 lines: manufacturer.

The password level can be changed from menu branch F.d. at any time. The password can also be changed in the corresponding menu branch.

5.4 Description menu

Main menu – Function tree

The following general rules apply to the user interface:

- The parameters are grouped by functions and where necessary repeated, for example the status of the compressors inputs/outputs is visible in both branch C.a.a (Compressors), and in branch B.a (Inputs/Outputs)
- The parameters are grouped by type of access, first User then Maintenance then Manufacturer
- The most frequently used parameters are indicated first, the less frequently used are last
- Each user only sees the parameters and menu items that are available for that access level
- Only the screens and parameters corresponding to the selected system configuration are visible, that is, corresponding to the devices configured. The exception to this rule involves the screens relating to functions that can be enabled/disabled (e.g. set point compensation), which are visible even when disabled.

Regardless of the current screen displayed, pressing the  button accesses the main menu, as shown below:



U	A. Unit Status	a. Main info		
		b. Set Point		
		c. On/Off		
I/O	B. IN/OUT	a. Status	a. Digital in	
			b. Analog in	
			c. Digital out	
			d. Analog out	
	b. Manual OP.	a. Digital out		
		b. Analog out		
	c. Test	a. Digital out		
		b. Analog out		
			a. I/O Status	
			b. Control	
C	C. COMPRESSORS	a. Line 1 (*)	c. OP. hours	
			d. Energy saving	
			e. Alarms	
			f. Config.	
			g. Advanced	
			...	
	b. Line 2 (*)			
			a. I/O Status	
			b. Control	
			c. EEV	
%	D. CONDENSERS	a. Line 1 (*)	d. Energy saving	
			e. Alarms	
			f. Config.	
			g. Advanced	
			...	
	b. Line 2 (*)			
			a. I/O Status	
			b. Control	
			c. EEV	
			d. Energy saving	
E	E. Other func.	a. Oil	a. Line 1 (*)	a. I/O Status
			b. Line 2 (*)	b. Settings
				...
		b. SubCOOL	a. Line 1 (*)	a. I/O Status
				b. Settings
				c. EEV
				...
		c. Economiser	a. Line 1 (*)	a. I/O Status
				b. Settings
				c. EEV
				...
		d. Liquid inj.	a. Line 1 (*)	a. I/O Status
				b. Settings
				...
		e. Heat recovery	a. Line 1 (*)	a. I/O Status
				b. Settings
				...
		f. generic func.	a. Stages	
	b. Modulation			
	c. Alarms			
	d. Time bands			
	e. I/O Status			
		a. I/O Status		
		b. Settings		
		...		
		a. I/O Status		
		b. Settings		
		...		
		a. Temperature control		
		b. Manual management		
		c. I/O Status		
		d. Control		
		e. Valve configuration		
		f. Driver configuration		
S	F. settings.	a. Clock	a. Time bands	
			b. Adjust	
		b. Languages		
		c. BMS	a. Line 1 (*)	
		b. Line 2 (*)		
A	G. Safety	d. Password		
		a. Log		
		b. Prevent	a. Line 1 (*)	
		b. Line 2 (*)		
		a. Line 1 (*)		
		b. Line 2 (*)		
?	H. Info			
S	I. Setup	a. Pre-configurations		
			b. Wizard	
			c. Advanced config.	
			d. Default	

(*) this menu level is only visible for system configurations with two lines.

Note:

- The figure illustrates the maximum menu configuration visible with the Manufacturer password. If accessing with the User or Maintenance password, only the menu items available are visible
- For some menu items, access is possible with different password levels (e.g. I/O status), but the information available on the screens changes.

6. FUNCTIONS

pRack pR300 can manage up to 2 suction lines and 2 condenser lines. Many of the functions described in this chapter apply in the same way to all the lines (e.g.: control, rotation), while others apply in the same way to the suction lines (e.g.: oil management). The exception involves the generic functions that apply, irrespective of line, suction or condenser, to pRack boards with pLAN addresses from 1 to 4.

Where not expressly indicated or where it is clear that the description refers to one specific line rather than another (e.g.: compressor or fan management), the descriptions are considered as being common to all lines; any specific Situations are described on a case-by-case basis.

Below is a chart of the main functions described and their field of application:

	Function	L1 suction	L2 suction	L1 condens.	L2 condens.
Control	Unit On-Off	√	√	√	√
	P+I control	√	√	√	√
	Control in Neutral zone	√	√	√	√
	Modulation in Neutral zone	√	√	√	√
	Control with backup probes	√	√	√	√
	Rotation	√	√	√	√
Compressors	Modulation device	√	√	√	√
	Screw compressors	√	-	-	-
	Reciprocating and scroll compressors	√	√	-	-
	Digital Scroll™ compressors	√	√	-	-
	Bitzer CRll compressors	√	√	-	-
Energy saving	Fan management	-	-	√	√
	Set point compensation	√	√	√	√
	Floating set point	√	√	√	√
Accessory functions	Oil management	√	√	-	-
	Subcooling	√	√	-	-
	Economizer	√	√	-	-
	Liquid injection	√	√	-	-
	Heat recovery	-	-	√	√
	Generic functions (*)	(*)	(*)	(*)	(*)
	ChillBooster	-	-	√	√
	DSS	√	√	-	-

Tab. 6.a

(*) not linked to lines, but rather the pLAN address of the boards

The functions are described in detail in the following paragraphs.

6.1 Unit On-Off

The unit can be switched on and off from:

- User terminal
- Supervisor
- Digital input

On-off from the user terminal and the configuration parameters are available under the main menu, branch A.c, and are differentiated based on the access level; the User password allows display only.

On-off from the supervisor and from the digital input and start-up after a blackout (with specific delay, to avoid continuous starts and stops in the event of instability in the power supply) must be enabled using the parameters visible only with the Manufacturer password.

On-off from the digital input is equivalent to an enabling Signal, that is, if the digital input is Off the unit cannot be switched on in any other way, while if is On, the unit can be switched on or off in any other way, with the same priority (the most recent control has precedence, whatever the origin), as shown in the figure:

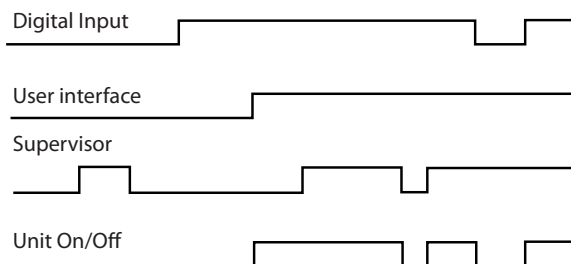

Fig. 6.a

When there are two suction and condenser lines, on-off is independent for each line, while when there are two suction lines and one condenser line, it is independent for the suction lines, while the condenser line stops when both suction lines are off, and starts when at least one suction line is on.

Note: Certain special conditions or functions in the pRack software cause the unit to shutdown:

- Configuration of some parameters: e.g. inputs/outputs, configuration of compressors, inverter parameters.
- Installation of default parameters
- Manual management

6.2 Control

pRack pR300 can manage two types of control:

- Proportional band (P, P+I);
- Neutral zone (fixed times, variable times).

Both types of control can be applied to both compressors and condensers, according to the settings defined during start-up or in main menu branches C.a.b/C.b.b and D.a.b/D.b.b.

The type of control chosen is independent for each line present, either suction or condenser.

In addition, pRack pR300 can use as the reference for control either the pressure or the converted temperature, or the temperature read by probe if there is no pressure probe, even if reference is only made to pressure below.

The control set point can be compensated by an offset linked to digital inputs, probes, supervisor or time bands, for details see paragraph 6.5 relating to compressor and fan energy saving.

Both types of control are described below, and are valid for both control of suction pressure and condensing pressure, and operation with backup probes and/or probes not working.

6.2.1 Proportional band

The operating principle is normal proportional or proportional + integral control (P, P+I).

The control set point is central, consequently - for proportional control only - operation is schematised in the following figure:

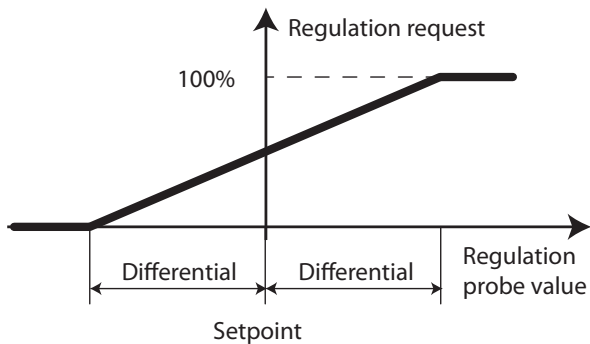

Fig. 6.b

For example, for 4 devices with the same capacity and proportional only control, start-up occurs as shown in the figure:

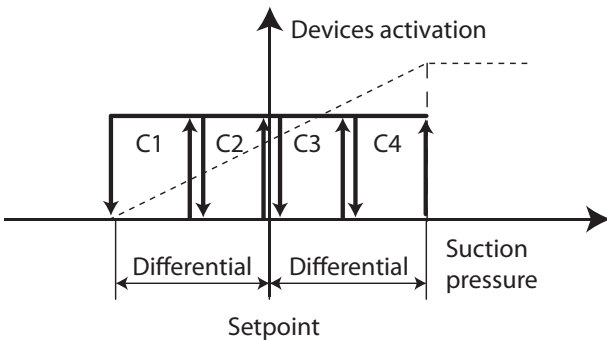

Fig. 6.c

With P+I control, added to the effect of the proportional action described above is the integral action, used to achieve a null control error in steady operation, as shown in the figure:

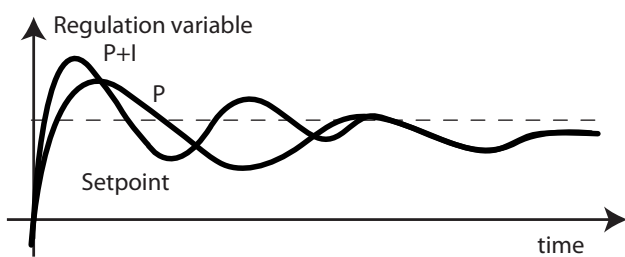

Fig. 6.d

The integral action depends on the time and the deviation from the set point. This modifies the request if the control value does not approach the set point for some time.

The integral time setting represents how fast integral control is implemented:

- low values determine fast and intense control action
 - high values determine slower and more stable control action
- It is recommended to not set a value that is too low for the integral time, to avoid instability.

Note: the set point is in the centre of the activation band, therefore when reaching the set point some devices are on, even with purely proportional control.

6.2.2 Neutral zone

The operating principle is schematised in the following figure:

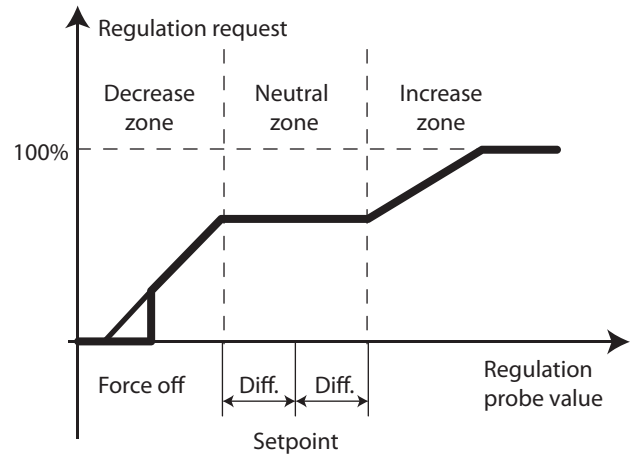

Fig. 6.e

Inside the neutral zone the capacity request sent by the controller is constant (except when there is a modulation device and modulation is enabled inside the neutral zone, as described in the following paragraph) and the value satisfies the temperature control request in those specific operating conditions, therefore within this zone no device is stopped or started.

In the decrease zone, the request also decreases at a rate that depends on the deviation from the set point, and vice-versa in the increase zone the request increases proportionally to the deviation.

For the increase and decrease zones, the following can be used:

- Fixed times: the request decreases or increases constantly as time elapses.
- Variable times: the request decreases or increases more quickly (according to the settings) as the deviation from the set point increases.

Note: The previous figure shows the increase and decrease with fixed times.

For control in Neutral zone, the parameters shown in the figure must be set:

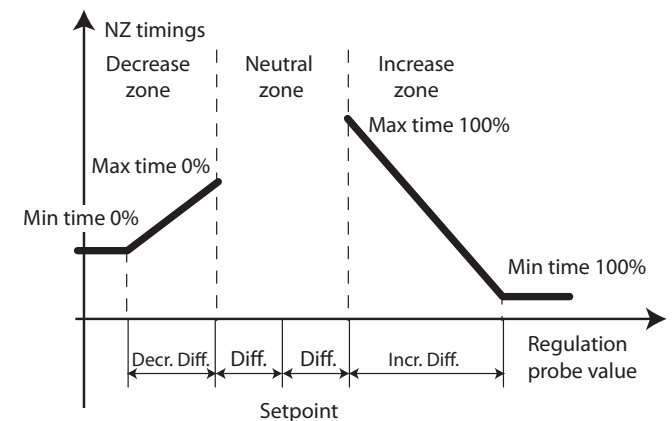

Fig. 6.f

As well as the decrease and increase differentials, 4 times need to be set, two for each zone, which represent the maximum and minimum time to reach the request, equal to 0% or 100%, for the decrease and increase respectively.

Tutorial: the decrease/increase times (minimum and maximum) represent the time needed to change from maximum to minimum capacity and vice-versa, and not the time between the deactivation/activation of the individual device. For example, in the case of 4 devices with the same capacity, an increase time of 180 s means that one device is activated every 45 s.

CAREL

In the situation shown in the figure, the request sent by the controller decreases/increases slowly as soon as the controlled value is outside of the Neutral zone, while it decreases/increases quickly the further the controlled value moves away from the Neutral zone; in this way the response of the system is faster when further from steady conditions.

Note: When using fixed times, the maximum and minimum must be set to the same value. In this case, the request sent by the controller decreases/increases constantly inside the deactivation/activation differential.

6.2.3 Modulation in Neutral zone

pRack pR300 can activate a specific function inside the Neutral zone if modulating devices are used (e.g.: inverters).

This function can be enabled in main menu branch C.a.g/C.b.g or D.a.g/D.b.g.

Modulation in Neutral zone is used to vary the request sent by the controller inside the Neutral zone proportionally so as to enter the decrease zone with the minimum request and the increase zone with the maximum request, meaning a device can be immediately deactivated/activated when exiting the Neutral zone.

This makes it possible to remain longer inside the neutral zone without starting or stopping any device.

An example of this operation is shown in the figure:

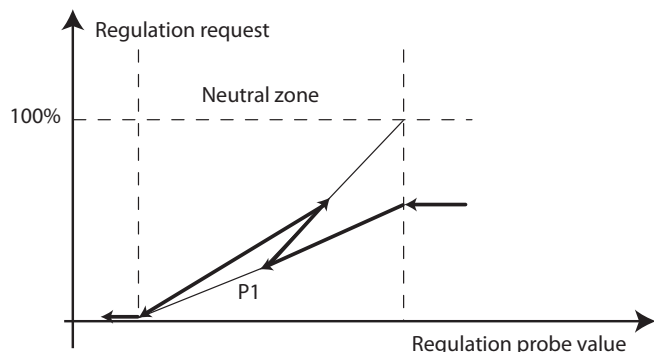

Fig. 6.g

When entering the Neutral zone, the pRack pR300 software calculates how the request needs to change in order to exit the Neutral zone at minimum or maximum output, and applies one of the two values according to the trend in variation in the control variable. For example, at point P1 in the figure, the trend of the two requests is represented by the segments with thin lines, and the request 'reverses' because at that point the control variable has started increasing in value again.

Note: When exiting the Neutral zone, it is possible that the request is not at the minimum or maximum value, where limitation is enabled for of the modulating device variation speed.

6.2.4 Control with backup probes and/or probes not working

pRack pR300 can use backup control probes that are activated when the normal control probes are not working.

The backup probes must be enabled in main menu branch C.a.g/C.b.g or D.a.g/D.b.g.

When different pRack boards are used to manage the suction and condenser lines, the backup suction pressure probe must be connected to the board that manages the suction line, while the backup condensing pressure probe can be connected either to the board that manages the suction line or the board that manages the condenser line.

If the main control probes are not working and no backup probes are fitted, or the backup probes are also not working, or the corresponding temperature probes are also not working, fixed values are used for the control request, set in main menu branch C.a.g/C.b.g or D.a.g/D.b.g.

6.2.5 Auxiliary control

pRack pR300 offers the possibility to control the compressors on a single suction line (or L1 for double lines) using an auxiliary probe. Normal control based on the suction pressure probe reading (or converted temperature) can be replaced by control based on a different probe. This solution can manage the secondary refrigerant in "water chiller" or "pumped" systems, offering greater system stability and at the same time guaranteeing compressor safety via the suction probe, which must always be installed.

Auxiliary control is enabled under "Compressors -> Control", selecting the type of control (by temperature or pressure) and the type of refrigerant, which may differ from the main one.

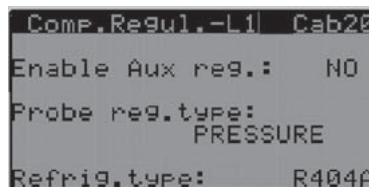

The function does not need to be enabled if "water chiller" is set in the installation Wizard

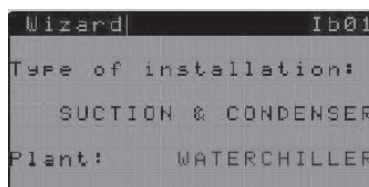

as auxiliary control by temperature probe is enabled automatically. Choosing a "pumped" system, on the other hand, automatically enables auxiliary control by pressure probe (see Appendix A.2)

Once the auxiliary probe is enabled on screen Cab20, the associated universal input, the probe type, the correct limits (for pressure probes) and calibration (if necessary) can be selected under "Inputs Outputs -> Status -> Analogue inputs"

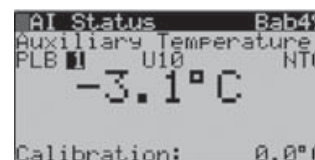
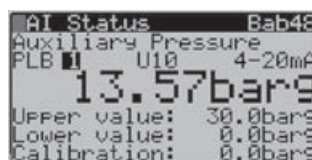

The type of control, band limits or differentials and the set point need to be configured under "Compressors -> Control", in the same way as for traditional control.

The limits for the auxiliary probe alarms, are set under "Compressors -> Alarms" and need to be configured depending on the type of probe and refrigerant. When an alarm goes off, this is saved in the log, with a special screen shown when pressing the alarm bell.

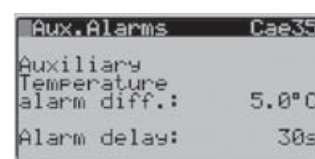
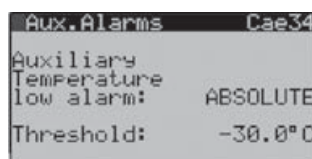
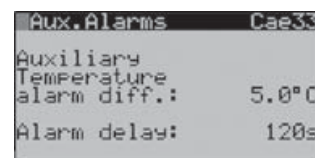
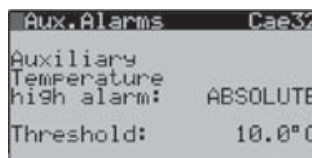

Note: when auxiliary control is enabled, it is recommended to also enable the prevent low suction pressure function, see paragraph 8.3.4 (prevent low suction pressure). In case of pumped systems, don't configure the second condensing line.

6.3 Compressors

pRack pR300 can manage up to 2 suction lines with different types of compressors and capacity modulation devices, applying common types of device rotation and controlling both the start mode and the safety times for each type of compressor, as well as a number of accessory functions.

The compressor functions and related parameter settings are enabled from main menu branch C.a/C.b.

These features and functions are described in detail in the following paragraphs.

6.3.1 Possible compressor configurations

pRack pR300 can manage different types of compressors:

- Reciprocating
- Scroll
- Screw

Moreover, a capacity modulation device is allowed for each suction line, which may be one of the following, according to the type of compressor:

Compressors and modulation devices

Compressors	modulation devices
Reciprocating	Inverter
Scroll	Inverter Digital Scroll™
Screw	Inverter Continuous capacity control
Bitzer CR11	Modulating capacity control

Tab. 6.b

Note: The same modulation device is used on each line.

The maximum number of compressors and load stages per line varied according to the type of compressor:

Compressors and modulation devices

Compressors	Maximum No.	Load stages
Reciprocating	12	24 total
Scroll	12	24 total
Screw	2	4
Bitzer CR11	2	3

Tab. 6.c

Note: Screw compressors can only be configured on line 1 and the board must be dedicated only to line 1. One Bitzer CR11 compressor can be configured for each line.

The compressor size refers to its capacity and number of load stages or to the inverter presence, therefore different sizes need to be defined for compressors with the same capacity yet a different number of load stages. The inverter is always associated to size 1.

Tutorial: below is one example of some possible configurations:

- One line, 4 reciprocating compressors with the same capacity, the first with inverter (2 sizes).
- One line, 4 scroll compressors with the same capacity, the first Digital Scroll™ (1 sizes).
- One line, 4 reciprocating compressors with the same capacity, the first two with 4 load stages, the other two not capacity-controlled (2 sizes).
- One line, 4 reciprocating compressors with the same capacity and 4 load stages each (1 size).
- Two lines, line 1 with 2 screw compressors with the same capacity, the first with continuous modulation, line 2 with 4 reciprocating compressors with two different capacities, the first two with 4 load stages, the other two with 2 load stages (1 size on line 1, 2 sizes on line 2).
- Two lines, line 1 with 4 scroll compressors, the first Digital Scroll™, line 2 with 4 reciprocating compressors, the first with inverter (1 size line 1, 2 sizes line 2).

6.3.2 Rotation

pRack pR300 can manage 4 different types of device rotation:

- FIFO (First In First Out): the first device to start is also the first to stop
- LIFO (Last In First Out): the last device to start is the first to stop
- By time: the device with the least number of operating hours starts and the device with highest number of operating hours stops
- Custom: the on/off sequences are defined by the user

Note: Different Sizes of compressors can only be managed with Custom rotation.

The type of rotation is selected and the corresponding parameters set during the start-up procedure or in main menu branch C.a.f/C.b.f.

The activation thresholds are calculated differently depending on whether FIFO, LIFO, time or Custom rotation is used:

Device activation threshold calculation

Rotation	Threshold calculation
FIFO	Static: the range of variation of the control request is divided equally between the number of stages available
LIFO	
By time	
Custom	Dynamic: the thresholds are calculated depending on the capacity effectively available

Tab. 6.d

Example 1: FIFO rotation, 4 compressors of the same capacity without load stages.

The activation thresholds are 25, 50, 75 and 100 %.

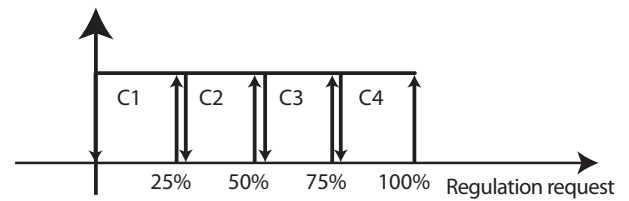

Fig. 6.h

Example 2: Custom rotation, 4 compressors with capacities of 10, 20, 30 and 40 kW. The activation thresholds with all the compressors available are 10, 30, 60, 100 %.

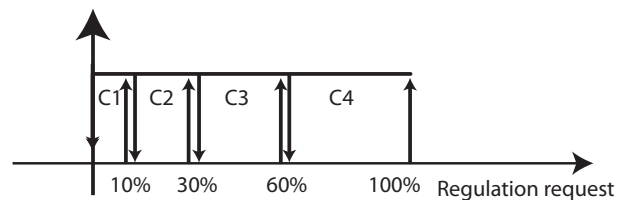

Fig. 6.i

If an alarm is active on compressor 3, the recalculated activation thresholds are 10, 30, 70 %.

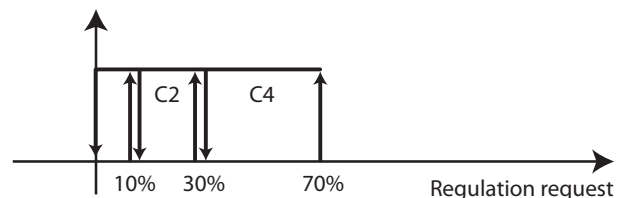

Fig. 6.j

Activation of the compressors and load stages may be:

- Grouped (CpppCppp): first all the load stages are activated on one compressor before starting the next one
- Balanced (CCpppppp): first all the compressors are started at minimum capacity and then the corresponding load stages are activated, one for each compressor, in sequence.

6.3.3 Rotation with modulation devices

pRack pR300 can also manage compressor rotation when a capacity modulation device is fitted (inverter, Digital Scroll™ or continuous control).

The type of modulating device is selected and the corresponding parameters set during the start-up procedure or in main menu branch C.a.f/C.b.f and C.a.g/C.b.g

The modulating device is always the first to start and the last to stop irrespective of the type of rotation, the other devices start or stop according to the type of rotation selected.

Note: The compressor with modulation device is also assumed to be the first.

The trend in capacity delivered by the modulation device depends on the capacity of the compressor with the modulating device compared to the other compressors available.

Three cases can be identified:

- compressors all with the same capacity and range of capacity variation of the modulating device greater than or equal to the capacity of the compressors
- compressors all with the same capacity and range of capacity variation of the modulating device less than the capacity of the compressors
- compressors with different capacities

In the first case, the modulating device manages to continuously cover the range of variation of the control request, while in the second case some discontinuous variations remain. The behaviour in the third case varies according to the capacities involved, and in any case reflects one of the two previous cases.

To configure the compressor capacity when an inverter is used, the minimum and maximum operating frequencies need to be set relating to the minimum and maximum value of the analogue output and the rated capacity delivered at rated frequency (50 Hz), so that the pRack pR300 software can calculate the capacity the compressor can deliver with the inverter and use this value for control. In addition, for inverters the variation in capacity delivered can be limited by setting the increase and decrease times. If these times have already been configured on the inverter, the higher time set has priority.

Example 1: range of modulating device capacity variation higher than the capacity of the compressors:

two compressors without capacity control, with the same capacity, 20 kW each, modulating device with variable capacity between 30 and 60 kW. The figure shows the trend when the request sent by the controller increases and then decreases continuously between 0 and 100%. It can be seen that the capacity delivered exactly follows the required capacity, except when below the minimum capacity of the modulating device.

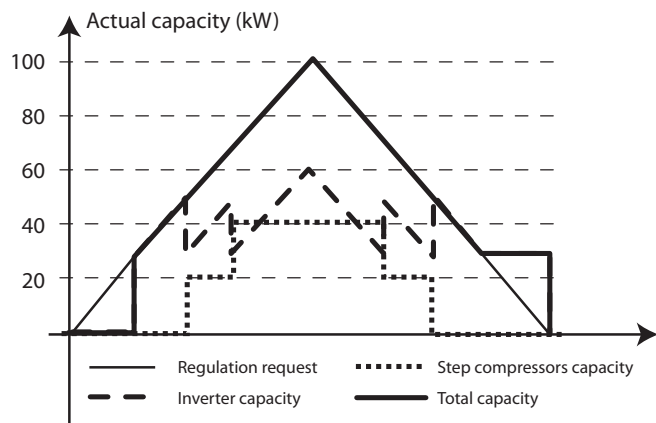

Fig. 6.k

Example 2: range of modulating device capacity variation lower than the capacity of the compressors: two compressors without capacity control, with the same capacity, 30 kW each, modulating device with variable capacity between 20 and 40 kW. It can be seen that the capacity delivered does not exactly follow the required capacity, rather acts in steps, so as to avoid swings.

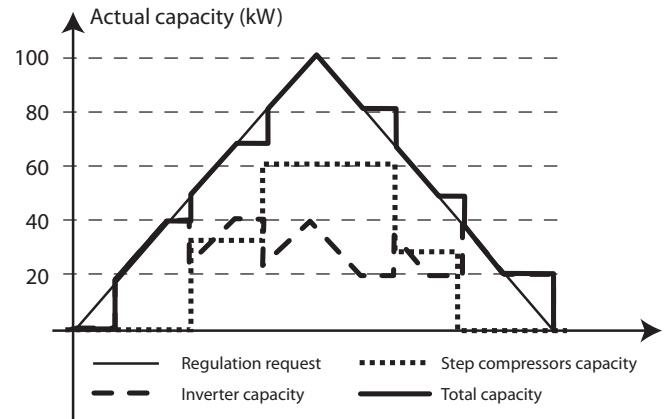

Fig. 6.l

Esempio 3: range of modulating device capacity variation in between the capacity of the compressors, all different sizes: two compressors without capacity control, capacities 15 kW and 25 kW, modulating device with variable capacity between 10 and 30 kW.

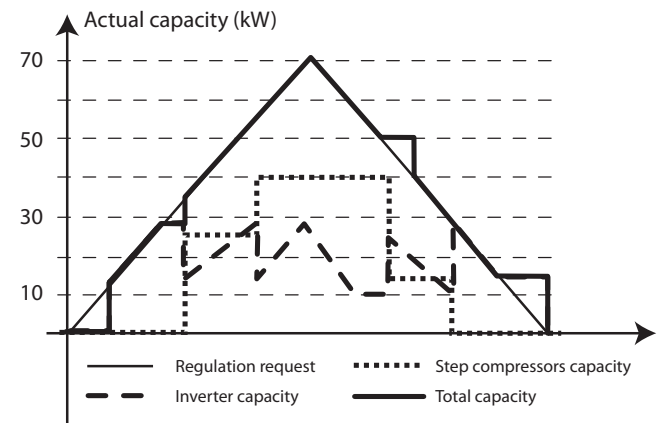

Fig. 6.m

6.3.4 Starting

pRack pR300 can manage different types of compressor starting:

- Direct
- Part-winding
- Star/delta

The type of starting can be selected and the related parameters set in main menu branch C.a.f/C.b.f.

For part-winding starting, the delay in activating the digital output that controls the second winding needs to be set:

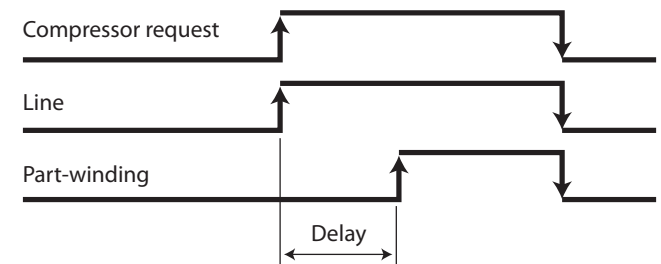

Fig. 6.n

For star/delta starting, the star time, the delay between the activation of the line and star digital input, and between the delta and star digital input all need to be set, as shown in the figure:

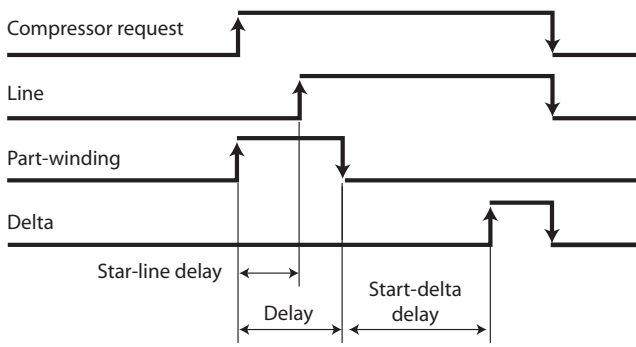

Fig. 6.0

6.3.5 Safety times

pRack pR300 can manage common safety times for each compressor:

- Minimum on time
- Minimum off time
- Minimum time between consecutive starts

In addition, pRack pR300 can manage the specific times for Digital Scroll™ compressors and screw compressors; for the descriptions see paragraphs 6.3.10 and 6.3.11. The related parameters can be set in main menu branch C.a.f/C.b.f.

Note: for two lines, a further delay can be set between starts of the compressors on different lines, so as to avoid Simultaneous starts. See paragraph 6.6.6 for the detailed description of the synchronisation function for two lines (DSS).

6.3.6 Balancing

pRack pR300 can control any balance valves in parallel with the compressors.

This function can be used to activate a communicating solenoid valve between compressor suction and discharge, for a set time, before each individual compressor starts. In this way, the suction and discharge pressure can be balanced and the compressor can be started in more favourable conditions.

The balancing function can be enabled and the related activation time set in main menu branch C.a.f/C.b.f.

6.3.7 Economizer

pRack pR300 can activate the economizer function to boost compressor efficiency by injecting vapour. Some of the liquid is taken from the condenser, expanded through a valve and then sent to a heat exchanger to cool the liquid leaving the condenser. The resulting superheated vapour is injected into a special section of the compressor.

The function can be enabled and the related parameters set in main menu branch C.a.f.

The function can be enabled and the related parameters set in main menu branch C.a.f.

The economizer is only efficient for high compressor activation capacities, typically over 75 %, therefore the economizer function control valve is only activated when exceeding a set threshold.

As the economizer tends to increase the condensing pressure, this needs to be controlled to ensure the high condensing pressure alarm is not generated. In addition, the injection of vapour decreases the discharge temperature and so this value also needs to be monitored.

Consequently, the three conditions for activation of the economizer function are:

- Capacity above a set threshold
- Condensing pressure below a set threshold (with reset differential)
- Discharge temperature above a set threshold (with reset differential)

Note: the function can be activated on a maximum of 6 compressors.

6.3.8 Liquid injection

As an alternative to the economizer, pRack pR300 can manage the injection of liquid into the compressors (the two functions are alternative, as the point of vapour injection into the compressor is the same).

The function can be enabled and the related parameters set in main menu branch E.d.a.b/E.d.b.b.

Liquid injection is used to protect the compressor, and in fact decreases the discharge temperature.

Operation is Similar to the economizer function, with the difference that the expanded liquid is not sent to a heat exchanger, but rather directly into the compressor. The function is only activated when the compressor is on and the discharge temperature exceeds a set threshold (with differential).

Note: the function can be activated on a maximum of 6 compressors.

6.3.9 Manual operation

pRack pR300 can manage 3 different compressor manual operating modes:

- Enabling / disabling
- Manual management
- Output test

Enabling / disabling is managed in main menu branch C.a.f/C.b.f., while manual management and the output test can be activated in main menu branch B.b or B.c.

Enabling / disabling is used to temporarily exclude the compressors from operation, to allow, for example, repair or replacement. The disabled compressors are also excluded from rotation.

Note: enabling is the only compressor manual operating mode that can be activated when the unit is on.

Both manual management and the output test are enabled by parameter and remain active for a set time after the last button is pressed, after which the unit returns to normal operating mode.

Manual management is used to switch the compressors on or off without observing the control needs, however still considering any safety devices (alarms, safety times, starting procedures) and respecting the set configuration of the inputs/outputs.

The activation screen resembles the one shown in the figure and is used to override the outputs relating to the operation of the selected device, e.g. compressor 1:

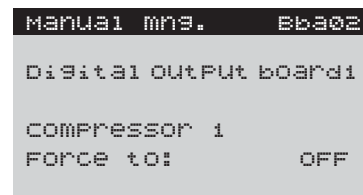

The output test is used to activate or deactivate the outputs (where necessary setting an output percentage for the analogue outputs), without observing any type of safety feature.

The activation screen resembles the one shown in the figure and is used to override the outputs on the pRack boards, in the order they physically appear on the board (without links to the devices):

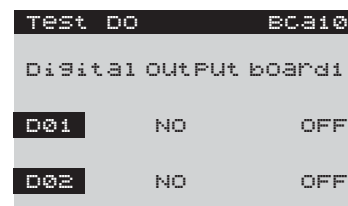

Important: manual mode and the output test can only be activated with the unit off.

Both manual mode and above all the output test must be used with special care and by expert personnel to avoid damage to the devices.

6.3.10 Digital Scroll™ compressors

pRack pR300 can use a Digital Scroll™ compressor as the modulating device for suction lines (one for each line). This type of compressor features special operation, and is controlled by pRack pR300 as follows. The related parameters can be set in main menu branch C.a.f/C.b.f. The capacity is modulated by opening/closing a valve with PWM; when the valve is ON the compressor delivers minimum capacity, while when the valve is off the compressor delivers maximum capacity. In the following description and figure, ON and OFF refer to the status of the compressor, while operation of the valve is the exact opposite:

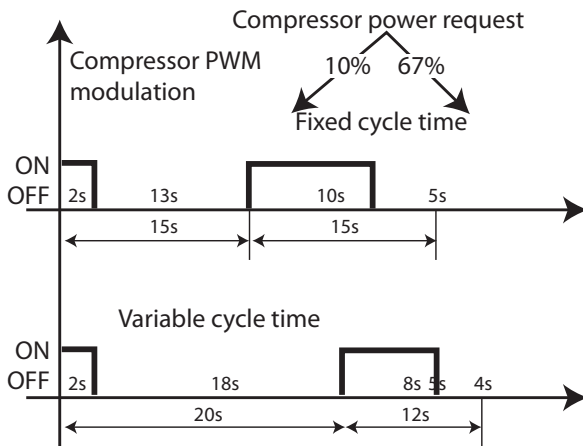

Fig. 6.p

The following data are provided by the manufacturer of the compressor:

- minimum ON time 2 s
- maximum cycle time 20 s
- optimum cycle time 12 s

There are three possible operating modes:

- Fixed cycle time
- Variable cycle time
- Optimised cycle time

Based on the operating mode selected, pRack pR300 calculates the valve activation percentage that satisfies the required capacity.

Fixed cycle time

The compressor ON time is calculated as the percentage of the cycle time corresponding to the required capacity:

$$T_{ON} = \% \text{ Request} * \text{Cycle Time}$$

The cycle time can be set to the optimum value suggested by the manufacturer to achieve maximum COP, or to a higher value to increase resolution of the capacity delivered (a higher cycle time implies greater continuity in the effective capacity that can be delivered).

Variable cycle time

The compressor ON time is set to 2 s and the cycle time is calculated based on the required capacity:

$$T_{CYCLE} = T_{ON} / \% \text{ Request}$$

Optimised cycle time

The compressor ON time is set to 2 s and the cycle time is calculated based on the required capacity for capacities less than 17 %, after which the cycle time is set to 12 s and the ON time varies. In essence, this mode is a combination of the previous two. This guarantees the maximum possible COP and control rate (obtained with the 12 s cycle time) and the maximum control range (starting from 10 %).

Note:

- the minimum capacity that can be delivered by Digital Scroll™ compressors is Minimum ON time/Maximum cycle time = 2/30 = 6.7 %, which also depends on the selected control mode (for example, in the first case shown in the figure the minimum capacity delivered is Minimum ON time/Cycle time = 2/15 = 13%).

- if high pressure prevention is enabled with activation/deactivation of the devices, the Digital Scroll™ compressor delivers the minimum possible capacity.

Starting procedure

pRack pR300 can manage the specific starting procedure for Digital Scroll™ compressors, as represented as in the following figure:

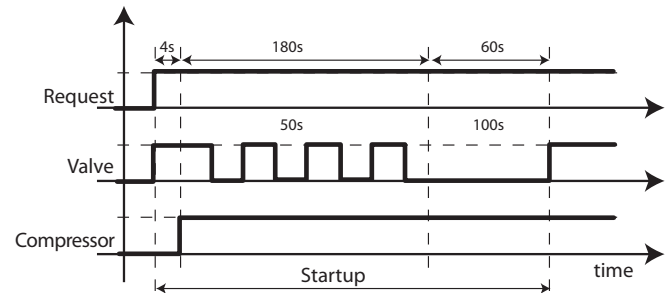

Fig. 6.q

There are three stages:

1. balance: the PWM valve is activated for 4 s, so that the compressor delivers minimum capacity;
2. compressor activation with 50 % capacity for 3 minutes;
3. forced operation at 100 % for 1 minute.

During the starting procedure, the request sent by the controller is ignored and only at the end of the procedure does the capacity delivered start reflecting the request. If the request is cancelled during the starting procedure, the compressor stops at the end, then the minimum ON time for these types of compressors is set to 244 s. The starting procedure is performed when the compressor is started, while it can be disabled for a set time by parameter for subsequent starts, if the compressor has not remained off for a minimum set time. After this time has elapsed the procedure is performed again during the following start.

Note: the safety times for Digital Scroll™ compressors are established by the manufacturer, and are as follows:

- Minimum ON time: 244 s (starting procedure)
- Minimum OFF time: 180 s
- Minimum time between restarts: 360 s

Alarms

pRack pR300 can manage, in addition to the common alarms for all types of compressors (see chapter 8 for details), some specific alarms for Digital Scroll™ compressors:

- high oil temperature
- oil dilution
- high discharge temperature

These alarms are managed as specified by the manufacturer of the compressor, and therefore pRack pR300 can only enable or disable them. Activation of these alarms requires an oil temperature probe, which can also be the common probe (see the paragraph relating to oil management) and the compressor discharge temperature probe.

Note: pRack pR300 does not manage the envelope for Digital Scroll™ compressors and consequently there is no corresponding alarm when operating outside the envelope.

6.3.11 Screw compressors

pRack pR300 can manage up to two screw compressors, with control in stages or continuous control (only the first compressor with continuous control, used as modulation device for the suction line), which can be a generic device or pre-configured in accordance with the most common devices supplied by the main manufacturers. Advanced functions are also available, for example envelope control, described further on. The parameters relating to screw compressors can be set in main menu branch C.a.f/C.b.f. Screw compressors are fitted with up to 4 capacity control valves (hereinafter V1, V2, V3, V4), which can have 4 types of behaviour:

- ON: the valve is open
- OFF: the valve is closed
- Intermittent: the valve is open/closed alternatively (around 10 to 15 s)
- Pulsating: the valve is open/closed alternatively with very short opening/closing times (around 1 to 2 s).

Important: pulsating valves must be associated with an SSR relay output, to avoid damage.

V1, V2, V3 and V4 can be managed to obtain stage or continuous compressor control.

Stage control

For the control in stages, normally involving four load stages, 25, 50, 75, 100 %, a table needs to be created that shows the behaviour of each valve in the different conditions (starting, 25 %, 50 %, 75 %, 100 %). The figure shows one possible example (see the documents supplied by the manufacturer of the compressor for how to complete the table):

	V1	V2	V3	V4
Start	○	○	○	○
25%	○	●	●	○
50%	●	○	●	●
75%	○	○	●	○
100%	○	○	○	○

Tab. 6.e

If intermittent valves are used, the cycle time also needs to be set.

Note: normally operation at minimum capacity (25 %) is only possible for a limited time, after which the compressor must switch to the next stage. This function can be enabled and the corresponding time can be set.

Continuous control

For continuous control, a table needs to be created that shows the behaviour of each valve in the different conditions (start/stop, increase, decrease, standby). The figure shows one possible example:

	V1	V2
Start/Stop	○	○
Increase (25 to 100%)	●	○
Decrease (25 to 100%)	○	●
Standby	●	○

Tab. 6.f

If intermittent/pulsating valves are used, the cycle time also needs to be set. Intermittent valves are opened/closed for 50 % of the set time, while for pulsating valves the opening and closing time in theory depend on the difference between the position of the slide and the capacity request. As the position of the slide is generally not measurable, the variation in the request is used to calculate the times for pulsating valves.

Note: in continuous control, operation is normally only allowed for an undetermined time when the capacity exceeds 50 %.

Starting procedure

pRack pR300 can manage the starting procedure for the screw compressors by considering, following the star/delta or part-winding starting selected, a further time of operation at minimum capacity, established by the manufacturer or set to 60 s for generic compressors. Once the starting procedure has ended, the compressor starts varying the capacity according to the control request and if necessary considering the duration at minimum capacity.

Series of compressors supported

pRack pR300 can manage several series of screw compressors made by the main manufacturers, (Bitzer, Refcomp, Hanbell, ...) which come with the parameters described above already set.

The models managed by pRack pR300 are shown in the table:

Manufacturer	Model
Bitzer	CSH65...95, HS,53-4/64, HS,74, HS85
Hanbell	RC2-100/140/180, RC2-170/200...1520
RefComp	134-S, 134-XS L1, 134-XS L2, SRS-S1XX...755, SRC-S785...985, SRC-XS L1, SRC-XS L2

Tab. 6.g

For manufacturers or series of compressors that are not supported, the generic type can be used and the corresponding parameters set as described previously.

Note: for further details on the series of compressors supported and the related pre-configured parameters, contact Carel.

Envelope

For screw compressors, pRack pR300 can manage control of the envelope, which can either be pre-set or defined by the user. pRack pR300 accepts the envelope control settings for the Bitzer CSH series compressors, and these simply need to be enabled in main menu branch C.a.g. For all other series of compressors, the envelope can be managed by enabling and setting all the related parameters in main menu branch C.a.g.

The following parameters need to be set in order to manage the envelope:

- Definition of the points (maximum 30)
- Definition of the zone (maximum 12). Each zone can be made up of one or more polygons (total maximum 14, which must be closed and convex)
- Definition of the behaviour of the compressor in the different zones (capacity and duration)

The meaning of the parameters is shown in the figure:

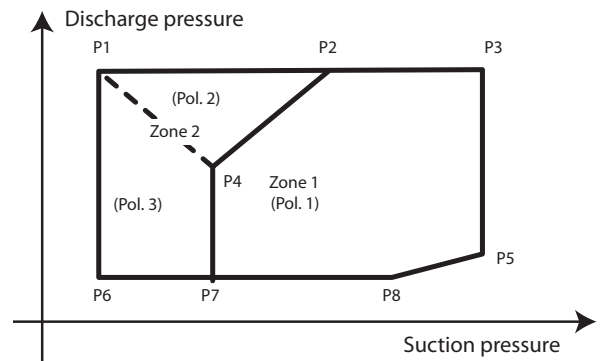

Fig. 6.r

pRack pR300 can also manage the variation in the envelope as the capacity delivered changes, for example in the case of variation in frequency for inverter-driven compressors.

Note: for further details on configuration of the envelope, contact Carel.

6.3.12 Bitzer CR11 modulating compressor

pR300 can manage a system fitted with CR11 compressors. Up to 2 CR11 compressors can be configured (one on each line), each as first compressor in L1 and L2.

CR11 is set as a capacity controlled piston compressor in which the capacity steps can be activated/deactivated rapidly (5 s). In addition, the CR11 compressor can be ON with the capacity steps deactivated, so as to respond faster to demand. This condition can remain active for a maximum set time, after which capacity control will be activated, in turn for a set time, to prevent compressor malfunctions.

Compressor capacity control is achieved by valves managed using SSR digital outputs, due to the high number of cycles involved. Up to 3 capacity steps can be configured on for each line (check the number of SSRs available).

Management by the pR300 of the different capacity steps allows complete compressor capacity modulation.

Capacity-control activation/deactivation

Capacity-control refers to the valve installed on the compressor. For 2 capacity steps, the compressor will be fitted with 2 valves and pRack needs to manage 2 SSR digital outputs. Capacity-control activation/deactivation refers then to energising/de-energising the valve, so as to open or close the flow of refrigerant. A step is activated when demand exceeds the corresponding capacity, vice-versa it is deactivated when demand falls to the lower step. The following figure represents an example of a CR11 with 2 capacity steps (50-100). The first steps is activated as soon as demand exceeds 50%, and the second when reaching 100%. When demand falls, on the other hand, the second step is deactivated as soon as this falls below 50%, and the first at 0%.

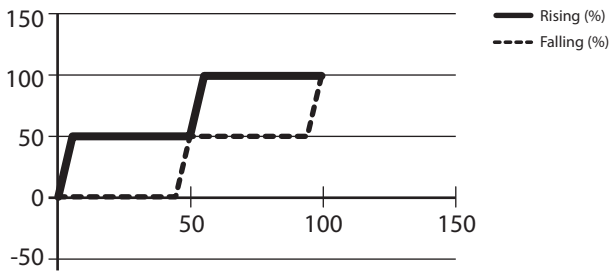

Fig. 6.aq

CRII modulation in neutral zone

The type of control can be selected between proportional-integral and neutral zone. If choosing neutral zone control, CRII compressor modulation can be enabled inside the zone. CRII modulation requires the definition of a new band, comprising the set point and a differential called "Diff CRII", this band defined must fall inside the neutral zone.

```
Comp.Regul. Cab08
Neutral zone manage
NZ diff.: 0.3barg
Activ.diff.: 0.7barg
Deact.diff.: 0.7barg
NZ diff.CRII: 0.2barg
```

CASE 1: suction pressure is inside the neutral zone and is increasing. Starting from current capacity, at the moment when "min mod" is exceeded, the compressor will activate the capacity steps until reaching "max mod" at 100%.

CASE 2: suction pressure is inside the neutral zone and is decreasing. Starting from current capacity, at the moment when "min mod" is exceeded, the compressor will deactivate the capacity steps until reaching "max mod" at 0%.

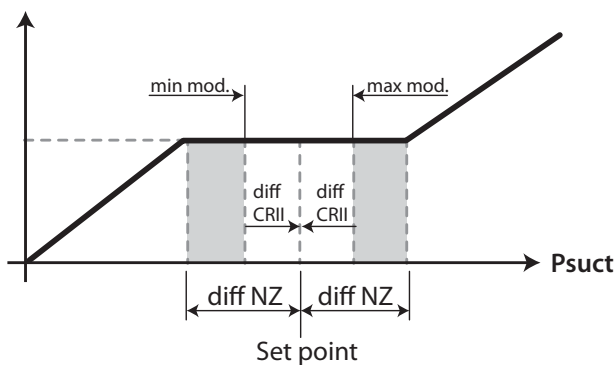

Fig. 6.ar

Legenda:

- MIN mod. = actual capacity CRII
- MAX mod. = 100% capacity
- ← MAX mod. = actual capacity CRII
- MIN mod. = 0% of CRII
- Total capacity doesn't change

In both cases, in the grey area between the neutral zone thresholds and the CRII differentials, total capacity does not change.

Note: when the suction pressure falls outside of the neutral zone, the compressors are switched off in sequence, varying CRII capacity to achieve correct modulation. The CRII compressor will go to 0% capacity before another compressor is shut down, and can remain in this condition for a set time, as long as there are other active compressors. If it is the last compressor active at that moment, after reaching 0% capacity it will immediately shut down.

```
Comp.Config. Caf88
CRII Compressor
Max time at 0%: 60s
Force comp.to min step
after max time: YES
Max.force on time: 60s
```

Configuration

A system with CRII compressors can be configured directly from the wizard. The following procedure shows the selection of a CRII compressor with two capacity steps, 50%-100%:

```
Wizard Ib05
Compressors confi9.
Modulate speed
device: BITZER CRII
(Only for first
compressor)
```

```
Wizard Ib31
Compressors confi9.
Enable: Stages[%]:
CR2: YES 50/100
S2: YES 100
S3: NO -
S4: -- -
```

```
Wizard Ib32
Compressors confi9.
C01:CR2 C02:S2 C03:S2
C04:-- C05:-- C06:--
C07:-- C08:-- C09:--
C10:-- C11:-- C12:--
```

Times

Min Ton, minimum ON time:

- 120 s up to 5.5kW
- 180 s up to 15kW
- 300 s above 15kW

Min Toff, minimum OFF time:

- range [5 s ... 999 s]

Min start same compressor, minimum time between two consecutive starts of the same compresso:

- range [5 s ... 999 s]

```
Comp.Config. Caf17
Compressor controlled
by CR2, timings
Min on time: 30s
Min off time: 60s
Min time to start
same compressor: 180s
```

Max time with compressor on with load bypassed is the maximum time in which the CRII compressor can remain active at 0% capacity after which capacity control will be activated.

- up to 120 s

```
L2-Comp.Config. Cbf88
CRII Compressor
Max time at 0%: 60s
Force comp.to min step
after max time: YES
Max.force on time: 60s
```

CRII unloader delay is the delay on activation of capacity control.

- range [5 s ... 999 s]

```
Comp.Config. Caf87
Compressor controlled
by CR2, timings
CRII unload.delay: 5s
```

Extra cooling fan

To prevent malfunctions of the CRII compressor due to high operating temperature, pR300 can activate a fan installed on the compressor to provide extra cooling. pR300 does not manage the CRII compressor envelope. The extra cooling fan is activated based on two variables:

- Current CRII capacity
- Condensing pressure

with specific cases for the medium temperature and low temperature line.

Fan for medium temperature line

The following parameters need to be set to manage the fan:

- Condensing pressure threshold (default 16 bars)
- Shutdown evaluation time with pressure higher than threshold(default 180 s)
- Shutdown evaluation time with pressure lower than threshold(default 60 s)
- Shutdown delay (default 20 s)



The following table highlights the cases in which the fan is activated with reference to the default values:

Condensing pressure (Pcond)	CR11 % activation (*)	Fan
Pcond >= 16bar	50% → 0%	Switch on
Pcond < 16bar	50% → 0%	Keep off or switch off after 0s + 20s
Pcond >= 16bar	0%	Keep on
Pcond < 16bar	0%	Keep off or switch off after 60 s + 20s
Pcond >= 16bar	50%	Keep off or switch off after 180 s + 20 s
Pcond < 16bar	50%	Keep off or switch off after 60 s + 20 s

Fan for low temperature line

The following parameters need to be set to manage the fan:

- Condensing pressure threshold P1 (default 7.5 bars) depending on the capacity step
- Condensing pressure threshold P2 (default 15 bars) depending on the capacity step
- Condensing pressure threshold P3 (default 19.5 bars) depending on the capacity step
- Shutdown evaluation time with pressure higher than threshold(default 180 s)
- Shutdown evaluation time with pressure lower than threshold(default 60 s)
- Shutdown delay (default 20 s)

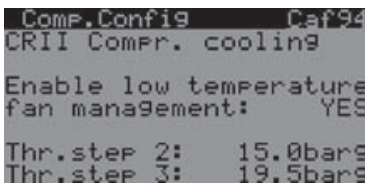

The following table highlights the cases in which the fan is activated with reference to the default values, with 3 capacity steps:

Condensing pressure (Pcond)	CR11 % activation (*)	Fan activation
Pcond < P1 (condition not allowed)	OFF	Keep off or switch off after 0s + 20s
P1 <= Pcond < P2	step1 → 0%	Switch on
P2 <= Pcond < P3	step1 → 0%	Switch on
Pcond >= P3	step1 → 0%	Switch on
P1 <= Pcond < P2	0%	Keep on
P2 <= Pcond < P3	0%	Keep on
Pcond >= P3	0%	Keep on
P1 <= Pcond < P2	step2 → step1	Keep off or check step1 switch off condition
P2 <= Pcond < P3	step2 → step1	Switch on
Pcond >= P3	step2 → step1	Switch on
P1 <= Pcond < P2	step1	Keep off or switch off after 60 s + 20s
P2 <= Pcond < P3	step1	Switch on
Pcond >= P3	step1	Switch on
P1 <= Pcond < P2	Step3 → step2	Keep off or check step2 switch off condition
P2 <= Pcond < P3	Step3 → step2	Keep off or check step2 switch off condition
Pcond >= P3	Step3 → step2	Switch on
P1 <= Pcond < P2	step2	Keep off or switch off after 60 s + 20s
P2 <= Pcond < P3	step2	Keep off or switch off after 180 s + 20s
Pcond >= P3	step2	Switch on
P1 <= Pcond < P2	step3	Keep off or switch off after 60 s + 20s
P2 <= Pcond < P3	step3	Keep off or switch off after 180 s + 20s
Pcond >= P3	step3	Switch on

6.4 Fans

pRack pR300 can manage up to 2 condenser lines with up to 16 fans and one speed modulation device each, applying common types of device rotation and controlling both the starting mode and some accessory functions. The modulation device may be an inverter or a phase fired controller. The fan functions and related parameter settings are enabled from main menu branch D.a/D.b. The functions are described in detail below.

6.4.1 Control

pRack pR300 can manage - as described in paragraph 6.2 - proportional band and Neutral zone control, by pressure or temperature. For details on the control modes, see the corresponding paragraph, while below is the description only of the features relating to the fans.

Fan operation depending on the compressors

The operation of the fans can be bound to the operation of the compressors by setting a parameter in main menu branch D.a.b/D.b.b, in this case the fans only start if at least one compressor is on. This setting is ignored if the fans are controlled by a dedicated pRack pR300 board and the pLAN network is disconnected.

Fan operation with modulating device

If the fans are controlled by a modulating device, the meaning of the parameters that associate the minimum and maximum values of the device's modulating output and the minimum and maximum capacity of the modulating device on screens Dag02 and Dbg02 is illustrated in the following examples.

Example 1: minimum modulating output value 0V, maximum value 10V, minimum modulating device capacity 0 %, maximum 100 %.

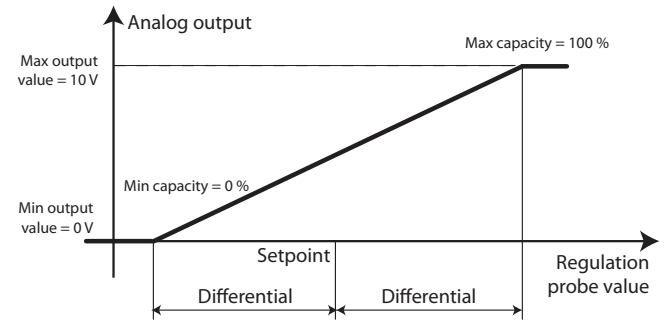

Fig. 6.s

Example 2: minimum modulating output value 0V, maximum value 10V, minimum modulating device capacity 60 %, maximum 100 %.

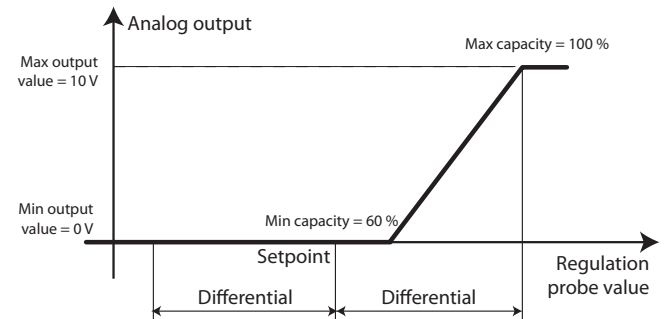

Fig. 6.t

Example 3: minimum modulating output value 2 V, maximum value 10 V, minimum modulating device capacity 60 %, maximum 100 %.

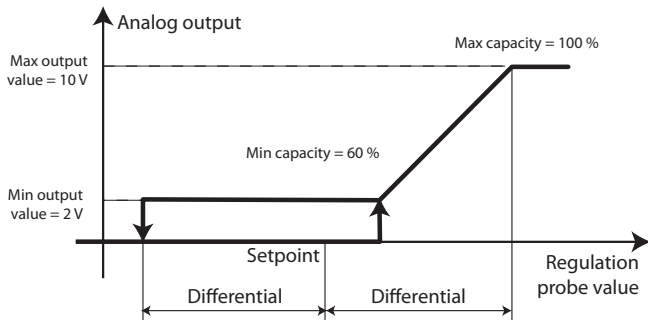

Fig. 6.u

Cut-off

pRack pR300 manages a control cut-off for the fans; functions and related parameter settings can be enabled from main menu branch D.a.b/D.b.b. The operating principle of the cut-off function is shown in the figure:

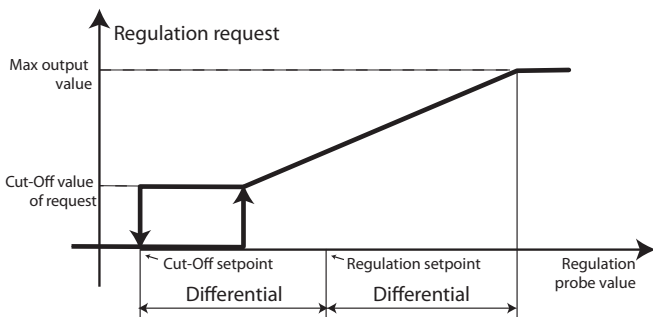

Fig. 6.v

A percentage of the control request and a cut-off set point can be set. When the control request reaches the set cut-off value, this value is kept constant until the control value falls below the cut-off set point, after which it falls to 0 % and remains there until the request exceeds the cut-off value again.

6.4.2 Rotation

pRack pR300 can manage rotation of the fans, much in the same way as described for the compressors, therefore:

- LIFO, FIFO, time, Custom rotation
- Management of a modulation device on each line

The substantial difference compared to the compressors concerns the possibility to manage different capacities and load stages, which are obviously not featured for the fans. In addition, pRack pR300 can specially manage inverter driven fans. In fact, a multiple number of inverter driven fans can be set.

If there is more than one fan, however the number of inverter driven fans is set to 1, the fans are started and stopped at the same time, and the fans will always all be at the same power.

If there is more than one inverter driven fan, as well as being able to use an alarm digital input for each, it is assumed that the weight of the modulating device is proportional to the number of fans, therefore the first case is applied, as described in paragraph 6.3.3: fans all with the same power and modulating device power variation range greater than or equal to the capacity of the other devices.

Example 1: 4 fans all controlled by the same inverter correspond to 1 fan with four times the power.

Note: some fans can be excluded from the rotation, for example in the winter; to do this use the split condenser function described in paragraph 6.4.5.

6.4.3 Fast start (speed up)

pRack pR300 can manage the fast start function (speed up), used to overcome the initial inertia of the fans.

The function can be enabled and the related parameters set in main menu branch D.a.g/D.b.g

If speed up is enabled, a start time can be set in which the fan speed is forced to 100%. If the outside temperature sensor is used, moreover, a threshold can be set (with reset differential) below which speed up is disabled, so as to not drastically lower the condensing pressure at start-up.

Note: speed up has lower priority than the Silencer function (see the following paragraph for the details), therefore if the Silencer function is active, this is disabled.

6.4.4 Silencer

pRack pR300 can manage the Silencer function, used to limit fan speed at certain times of the day or in specific conditions, enabled by digital input. The function can be enabled and the related parameters set in main menu branch D.a.g/D.b.g.

Enabling fan speed limitation from the digital input or based on time bands is independent, consequently the speed is limited to the set value when at least one of the two conditions is active.

Up to 4 activation bands can be set for each day of the week.

6.4.5 Split condenser

pRack pR300 can manage the possibility to exclude some fans from operation, for example to reduce condenser operation in winter, using the split condenser function.

The function can be enabled and the related parameters set in main menu branch D.a.g/D.b.g.

Split condenser can be used to exclude from rotation fans whose index is:

- even
- odd
- higher than a settable value
- lower than a settable value

The function can be activated by:

- time bands (winter/summer seasons)
- digital input
- supervisor
- outside temperature (set threshold and differential)

Note:

- the split condenser function can be disabled by parameter if the high pressure prevention function is activated (see paragraph 8.3.3). If split condenser is disabled due to activation of the high pressure prevention function, it remains disabled for a set time, after which it is reactivated.
- split condenser cannot be enabled if there is a speed modulation device that controls all the fans.

6.4.6 Manual operation

pRack pR300 can also manage the same three manual operating modes for the fans as described for the compressors:

- Enabling
- Manual management
- Output test

Enabling is managed in main menu branch D.a.f/D.b.f., while manual management and the output test can be activated in main menu branch B.b or B.c. For the detailed description of the three modes, see paragraph 6.3.9.

6.4.7 Alarms

pRack pR300 can manage both a common alarm for the fans and separate alarms for each fan.

When the common alarm is active the alarm is signalled, but no fan is stopped, while for separate alarms the fan that the alarm refers to is stopped. For details on the fan alarms, see Chapter 8.

6.5 Energy saving

pRack pR300 can activate energy saving functions by adjusting the suction and condensing pressure set points.

The suction and condensing pressure set points can be applied with two different offsets, one for the closing period and one for the winter period, activated by:

- Digital input
- Time band
- Supervisor

In addition, the suction pressure set point can be modified from analogue input, applying a linearly variable offset based on the value read by a probe.

As well as set point compensation from digital input, scheduler, supervisor or analogue input, two further energy saving functions are available, floating suction and condensing pressure set point.

The functions can be enabled and the related parameters set in main menu branch C.a.d/C.b.d and D.a.d/D.b.d.

6.5.1 Set point compensation

Compensation from digital input, scheduler or supervisor is similar for the suction and condensing pressure set points, consequently the following description applies to both.

Two different offsets can be defined, which apply to:

- Closing periods, defined by the scheduler, activation of a digital input or supervisor
- Winter period, defined by the scheduler

The two offsets add to the set point defined by the user when the corresponding condition is active.

Example 1: closing offset 0.3 barg, winter offset 0.2 barg, suction pressure compensation from scheduler and from digital input activated. When the digital input is activated, for example with a day/night function, 0.3 barg is added to the operating set point, and when the winter period is in progress a further 0.2 barg is added. The operation can be schematised in the following figure:

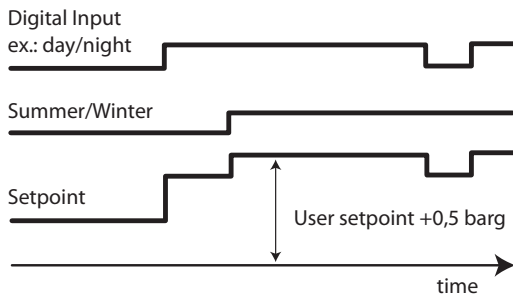

Fig. 6.w

Note: the same digital input is used for set point compensation on each line, so if suction and condensing pressure set point compensation is activated by digital input, both compensation functions are active at the same time.

Compensation from analogue input only applies to the suction pressure set point and can be enabled separately. If compensation from analogue input is enabled, a offset that is linearly variable to the value read by a dedicated probe can be applied to the suction pressure set point, as shown in the figure.

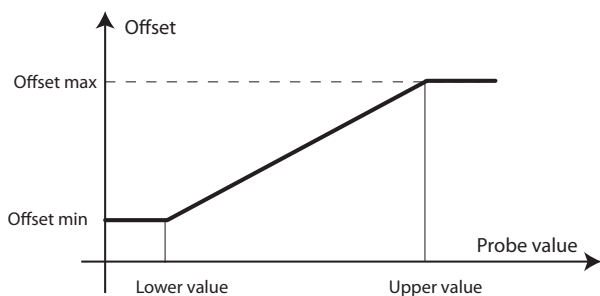

Fig. 6.x

6.5.2 Floating suction pressure set point

For the suction line, the floating set point is managed by the supervisor. The suction pressure set point set by the user is changed by the supervisor in range between a settable minimum and maximum. The operation is illustrated in the following figure:

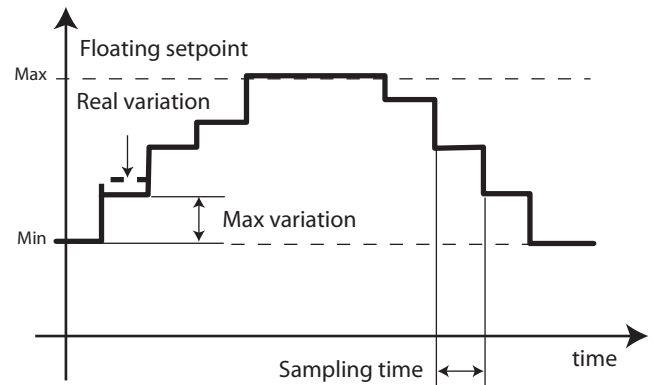

Fig. 6.y

The set point is calculated by the supervisor and acquired by the pRack pR300 controller at set intervals, the maximum variation allowed for the set point in each sampling period can also be set; if the value acquired differs from the previous value by more than the maximum variation allowed, the variation is limited to the maximum value. If the supervisor is disconnected, after 10 minutes (fixed) the pRack pR300 controller starts decreasing the set point with variations equal to the maximum variation allowed each sampling period, until reaching the minimum set point allowed with floating suction pressure.

Note: if set point compensation from scheduler, digital input or supervisor is also active, the offset is added to the minimum and maximum limits for the floating set point.

6.5.3 Floating condensing pressure set point

For the condenser line, the floating set point is based on the outside temperature. The floating condensing pressure set point is achieved by adding a constant programmable value to the outside temperature and limiting the resulting value between a settable minimum and maximum, as shown in the figure:

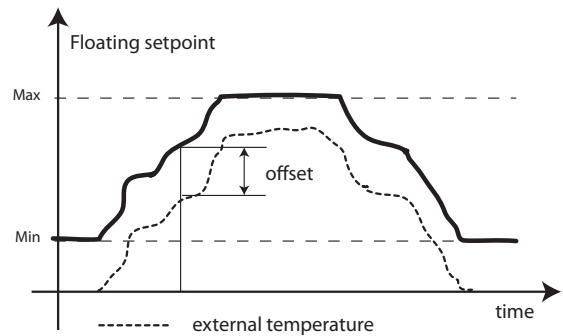

Fig. 6.z

Note: if set point compensation from scheduler, digital input or supervisor is also active, the offset is added to the minimum and maximum limits for the floating set point.

6.6 Accessory functions

pRack pR300 can manage several accessory functions. Of these, the economizer and liquid injection have already been described in paragraph 6.3 on compressor operation, while the others are described below.

6.6.1 Oil management

pRack pR300 features oil management for the individual compressors, as well as common management for each line:

- Individual compressor: oil alarm, high oil temperature, and, for screw compressors only, oil warning, oil cooling and oil level
- Line: common oil alarm, high oil temperature warning, oil cooling

The function can be enabled and the related parameters set in main menu branch E.a.a/E.a.b or C.a.e/C.b.e (for the individual compressor alarms).

Individual compressor oil management

For the description of the oil alarm and warning corresponding to the individual compressor see Chapter 8. For screw compressors, an oil cooler can be managed for each compressor, made up of a heat exchanger, a fan and 1 or 2 pumps. The operation of the cooler varies according to the setting of the output, which may be:

- Analogue: one pump only
- Digital: 1 or 2 pumps

The control probe is the compressor oil temperature probe, and the following need to be set: set point, differential and, for 2 pumps only, an activation delay for the second pump. The operation of the cooler when using an analogue output is shown in the figure:

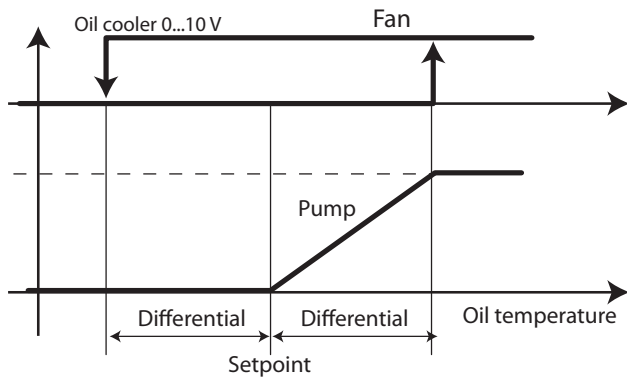

Fig. 6.aa

If a digital output and just one pump is used, the fan and the pump are activated/deactivated at the same time:

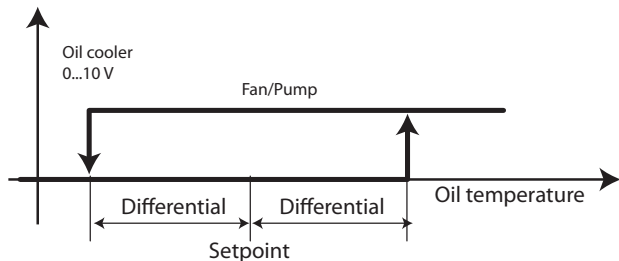

Fig. 6.ab

If a digital output and two pumps are used, the operation of the fan and the first pump is similar to the previous case, while the second pump is activated when the oil temperature is greater than the set point + differential for a time at least equal to the delay, and is deactivated when the oil temperature falls back below the set point minus the differential. The oil level can be managed for the first 6 compressors on each suction line. If a compressor alarm is configured as an oil alarm, this alarm can be associated with oil level management, enabling the function and setting the compressor alarm number to be used: when the digital input associated with the alarm is activated (this thus signals the low oil level), a valve is activated with intermittent operation to restore the level, with opening and closing times that can be set. If after a set time, the digital input is still active, that is, the minimum level has not been reached, pRack pR300 signals an alarm and stops the compressor.

Line oil management

pRack pR300 features an alarm digital input for each line; this is with signal only, that is, has no effect on the operation of the devices. For details on this alarm see chapter 8.

For all types of compressors, a common oil cooler can be managed for each line; the operation of this is similar to the cooler for each individual compressor described previously.

Note: for screw compressors, if common cooling is selected, cooling for each compressor cannot be activated.

6.6.2 Subcooling

pRack pR300 can control subcooling in two different ways:

- with the condensing temperature and the liquid temperature
- with the liquid temperature only

In the first case, subcooling is calculated as the difference between the condensing temperature (obtained by converting the condensing pressure) and the liquid temperature measured after the exchanger. The corresponding output is activated below a set threshold, with fixed differential.

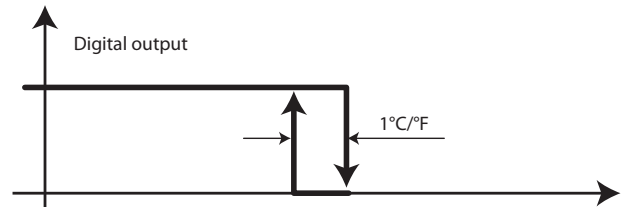

Fig. 6.ac

In the second case, the output is active for liquid temperature values greater than a threshold, with fixed differential.

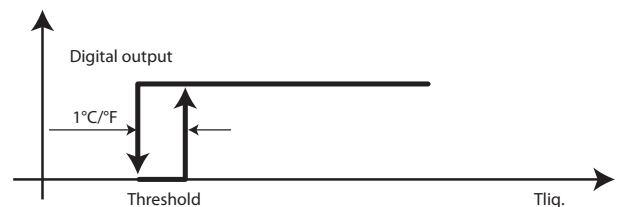

Fig. 6.ad

The subcooling function can be enabled and the related parameters set in main menu branch E.b.a/E.b.b.

Note: the subcooling function is active when at least one compressor is on.

6.6.3 Heat recovery

pRack pR300 can manage heat recovery for types of system with heat recovery in series with the main condenser.

Heat recovery can be activated by:

- Probe
- Time bands
- Supervisor

The heat recovery function can be enabled and the related parameters set in main menu branch E.e.a/E.e.b.

A digital input is managed that acts as a trigger for activating the function. When the digital input is not active, heat recovery is not operating, while when the digital input is active heat recovery is operating when at least one of the other conditions is true, as shown in the figure:

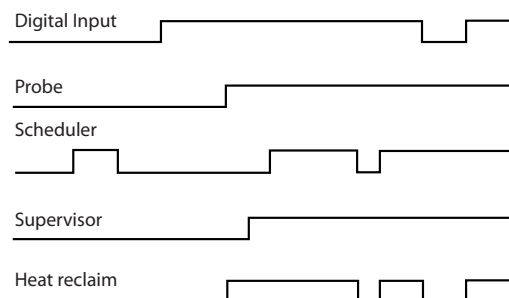

Fig. 6.ae

If the digital input is not configured, only the other conditions are taken into consideration.

When the heat recovery function is active, a digital output is activated to trigger the pump and a digital or analogue output for an On/Off or modulating 3-way valve.

For activation by probe, the operation of the On/Off or modulating 3-way valve and the pump is shown in the figure, where the temperature considered is the heat recovery exchanger outlet temperature:

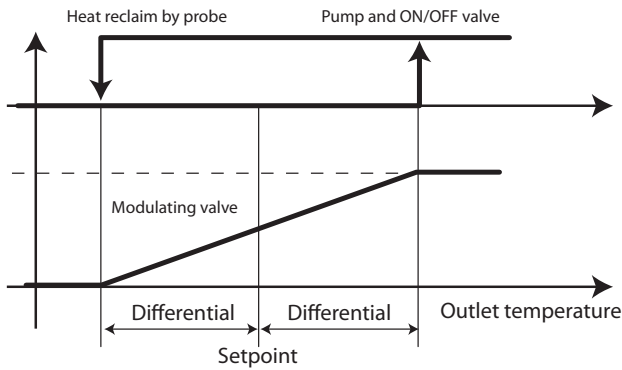

Fig. 6.af

If the probe is not working, pRack pR300 considers the other conditions, without Signalling further alarms in addition to the probe alarm. As regards activation from time bands, heat recovery does not consider the operating seasons, and links can be set to special days and closing periods so that heat recovery is only active based on the daily bands set.

Note:

- a settable bottom limit is available for the condensing pressure, below which heat recovery is deactivated.
- condensing pressure set point compensation can be disabled when heat recovery is active..

Heat recovery as the first stage in high pressure prevention

Heat recovery can be used to prevent high condensing pressure. The parameters relating to this function can be set in branch G.b.a/G.b.b of the main menu, after having enabled the heat recovery function. For details on operation of the prevent function, see paragraph 8.3.3. Heat recovery operation as the first stage in high pressure prevention is shown in the figure:

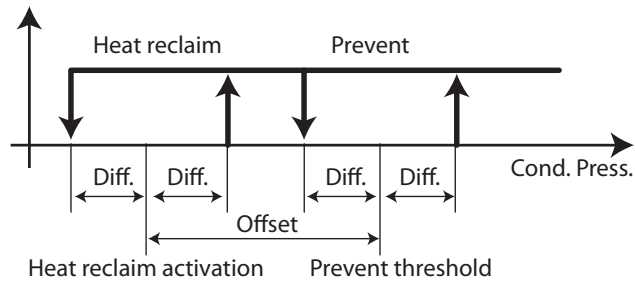

Fig. 6.ag

The function must be enabled and an offset must be set in relation to prevent threshold, while the differential is the same set for the prevent function.

6.6.4 Generic functions

pRack pR300 can use the free inputs /outputs and certain internal variables for generic functions.

Important: The generic functions are available on pRack pR300 boards with pLAN addresses from 1 to 4, that is, on all boards that manage a suction or condensing line, nonetheless only the parameters corresponding to the functions managed by boards 1 and 2 are sent to the supervisory system.

The following generic functions are available for each board:

- 5 stages
- 2 modulations
- 2 alarms
- 1 scheduler

Each function can be enabled/disabled by digital input and from the user interface.

The generic functions can be enabled and the related parameters set in main menu branch E.f. To be able to use the free inputs, these must be configured as generic probes from A to E (analogue inputs) and generic inputs from F to J (digital inputs), consequently a maximum of 5 analogue and 5 digital inputs can be used. After having configured the generic probes, the associated variables can be used as control variables and the digital inputs as enabling variables.

As well as the generic probes and inputs, pRack pR300 software internal variables can be used, depending on the system configuration. Some examples are, for analogue variables:

- Suction pressure
- Condensing pressure
- Saturated suction temperature
- Saturated condensing temperature
- Suction temperature
- Discharge temperature
- % of compressors active
- % of fans active
- Superheat
- Subcooling
- Liquid temperature,
- % compressor request
- % fan requesti

And for the digital variables:

- High suction pressure alarm
- Low suction pressure alarm
- High condensing pressure alarm
- Sign of life
- Prevent active

Each generic function can be associated with a unit of measure and a description. Below is a description of the operation of four types of generic functions.

Stages

pRack pR300 can manage up to 5 stage functions, with either direct or reverse operation. In both cases, a set point and a differential can be set; the operation of the corresponding output is shown in the figure for both cases:

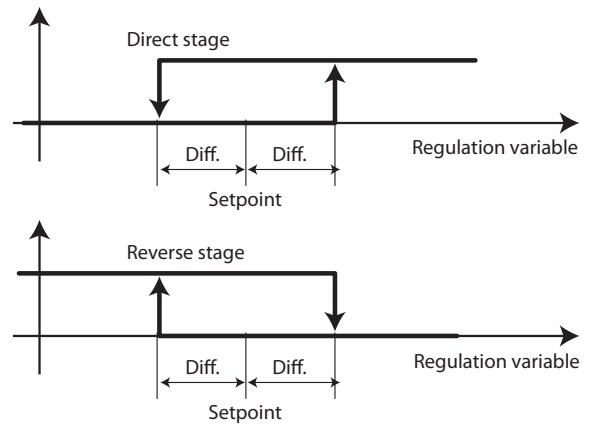

Fig. 6.ah

If an enabling variable has been set, the corresponding output is active if the enabling is also active.

For each stage, a high alarm threshold and a low alarm threshold can be set, and are absolute. For each alarm, the activation delay and priority can be set. See chapter 8 for details on the alarms.

One example of using the generic stage functions may be activation of the fans on the room units based on the temperature.

Modulation

pRack pR300 can manage up to 2 modulation functions, with either direct or reverse operation. In both cases, a set point and a differential can be set; the operation of the corresponding output is shown in the figure for direct mode, with the cut-off function also enabled:

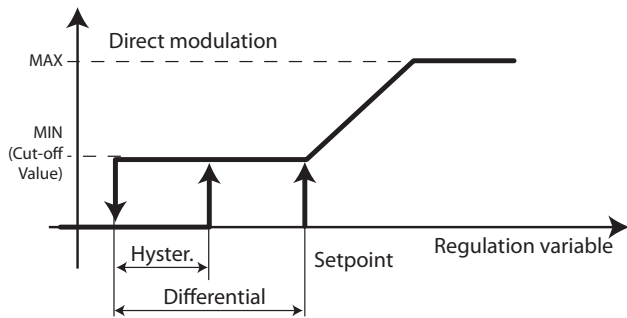

Fig. 6.ai

If an enabling variable has been set, the corresponding output is active if the enabling is also active. For each modulation, a high alarm threshold and a low alarm threshold can be set, and are absolute. For each alarm, the activation delay and priority can be set. See chapter 8 for details on the alarms. For modulation a minimum and maximum value can also be set for the output, and the cut-off function can be enabled, with operation as shown in the previous figure.

Alarms

pRack pR300 can manage up to 2 alarm functions, with settable digital variable to be monitored, activation delay, priority and description. Each generic function can be associated with a digital output for the activation of external devices when the alarm is activated. One example of using the generic alarm functions involves detecting gas leaks.

Scheduler

pRack pR300 can manage a generic scheduler that activates a digital output at certain time bands. Up to 4 daily time bands can be set for each day of the week, in addition operation of the generic scheduler can be linked to the common scheduler, and consequently the output activated based on:

- summer/winter
- up to 5 closing periods
- up to 10 special days

See paragraph 6.7.2 for details on the time bands.

6.6.5 ChillBooster

pRack pR300 can control the Carel ChillBooster, device used for evaporative cooling of the air that flows through the condenser. ChillBooster can be enabled and the related parameters set in main menu branch E.g. ChillBooster is activated when two conditions exist:

- the outside temperature exceeds a set threshold
- the fan control request is at the maximum for at least a settable number of minutes

The maximum request time starts counting again whenever the request decreases, therefore the request must remain at the maximum for at least the set time. Activation ends when the request falls below a set threshold. pRack pR300 can manage an alarm digital input from ChillBooster, the effect of which is to deactivate the device. For details see Chapter 8. As the number of operating hours of ChillBooster is critical as regards formation of scale on the condenser, pRack pR300 can manage the operating hour threshold, which should be set to 200 hours.

Hygiene procedure

To avoid water stagnation in the pipes, a hygiene procedure can be enabled that activates ChillBooster every day for a set time, if the outside temperature is greater than a threshold.

Note: if the outside temperature probe is not configured or is configured but is not working, ChillBooster operates based solely on the control request, and the hygiene procedure can still be activated.

The only difference between probe not configured and probe not working concerns the ChillBooster operating without temperature probe alarm, which is only generated when the probe is configured but not working.

ChillBooster as the first stage in high pressure prevention

ChillBooster can be used to prevent high condensing pressure.

The parameters relating to this function can be set in branch G.b.a/G.b.b in the main menu, after having enabled the ChillBooster function.

For details on the prevent function see paragraph 8.3.3.

Operation of ChillBooster as the first stage in high pressure prevention is similar to the heat recovery function described in paragraph 6.6.3.

The function must be enabled and an offset must be set in relation to the prevent threshold, while the differential is the same as set for the prevent function.

6.6.6 Double line synchronisation (DSS)

pRack pR300 can manage, for two line configurations, several synchronisation functions between the two lines:

- Disable simultaneous compressors starts
- Force the medium temperature line on if the low temperature line is activated
- Shutdown the low temperature line if the medium temperature line has a serious alarm
- Enable pump-down medium temperature line

The four DSS functions can be enabled independently and are useful for booster or CO2 cascade system configurations:

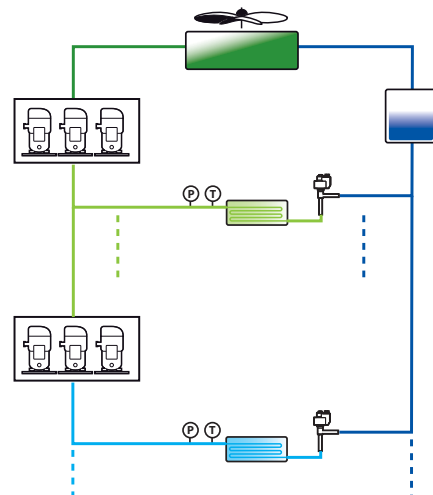

Fig. 6.aj

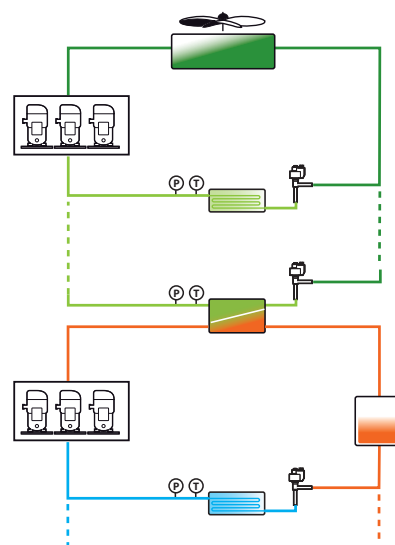

Fig. 6.ak

Important: in the pRack pR300 software assumes that the medium temperature line is line L1, while the low temperature line is line L2.

DSS can be enabled and the related parameters set in main menu branch E.h.

Disable simultaneous starts

Disabling simultaneous compressor starts may be useful for all system configurations with two separate lines and in cascade system configurations. The function to avoid simultaneous starts can be enabled, setting a delay time between the starts of compressors on different lines.

Forcing the medium temperature line

Forcing the medium temperature line may be useful for cascade system configurations and involves, once enabled, forcing at least one compressor on medium temperature line L1 to start at minimum capacity, if at least one compressor on low temperature line L2 is running. This means that before the low temperature line starts, the DSS function forces at least one of the compressors on medium temperature line L1 to start. The low temperature line L2 thus has higher priority than the control request for medium temperature line L1.

Shutdown the low temperature line

The low temperature line is shutdown by the DSS function if a serious alarm is activated on the medium temperature line, or, in general, if the medium temperature line is OFF.

Enable pump-down medium temperature line

During normal compressor rack operation, when at least one compressor on the low temperature line is running, the medium temperature compressor control will enable pump-down. If there is demand on the low temperature line, the minimum capacity step for medium temperature line will be guaranteed if MT suction pressure is not lower the set threshold.

Note: in the event of pLAN network faults, DSS is disabled.

6.6.7 Electronic valve synchronisation (EVS)

For configuration of the DRIVER or DRIVERS, where there are two heat exchangers, access OTHER FUNCTIONS→EVS; which comprises the following submenus:

- a. Temperature control
- b. Manual management
- c. I/O status
- d. Control
- e. Valve configuration
- f. Driver configuration

Temp. control:	Information relating superheat is shown
Manual management:	The valve can be moved to a certain number of steps
I/O status:	Display and configuration of the probes connected to the 4 analogue inputs on the driver
Control:	Valve opening, PID parameters, alarm limits/delays
Valve configuration:	Minimum/maximum number of steps, nominal frequencies
Driver configuration:	Enable driver, defaults

For branches a, b, c, d, e, f refer directly to the parameter table in chapter 7, while for a more detailed explanation of the DRIVER EVD EVO functions, see the technical manual: +0300005EN

Note: one DRIVER is needed for each valve; if a Twin Driver is used, this will be managed as a single driver; also the connection must be made on the first valve (EXV1-J27 in the case of built-in drivers).

Enable driver:

The driver can be enabled in the configuration menu (E.i.f) and once enabled, the number of valves and corresponding addresses of the two drivers can be entered.

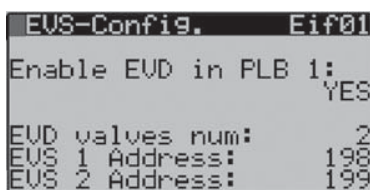

Fig. 6.as

The Driver is enabled automatically when the system selected in the Wizard is either "Cascade" or "Pumped".



Note:

- make sure that Fieldbus driver management reflects the logic of the generic functions, i.e. up to 2 drivers per suction line can be enabled, with a limit of 2 drivers per board in the pLAN (L1&L2 on single board, maximum 2 drivers);
- on the supervisor, L1, L2 management on separate boards requires the use of two single line templates;
- a Fieldbus driver cannot be connected to boards 3 and 4 in pLAN.

Screen Eif02 contains the commands to set the defaults for the Driver, after which the parameters are updated (pRack→Driver,); in addition, the line of compressors used for the pre-positioning logic can be selected.

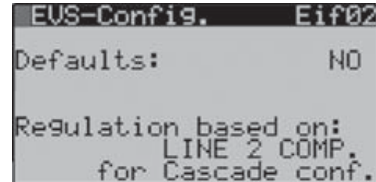

Fig. 6.at



Note:

- Control based on line 1 is only possible on pLAN board with address 1. While control based on the compressors on line 2 is only possible on boards where the low temperature compressors are configured (pLAN 1 for double suction on single board and pLAN2 for double suction on separate boards);
- important, if the line is not managed on the current board, the Driver function is disabled.

COMMON varying cooling capacity

Pre-positioning/start control: if switching from standby to control, before actual control starts the valve is moved to a specific initial position. The pre-positioning time is the time in which the valve is kept in a fixed position, according to the parameter "Valve opening at start-up".

Parameter/Description	Def.	Min.	Max.	UOM
CONTROL				
Pre-positioning time	6	0	18000	s
Valve opening at start-up (evaporator /valve capacity ratio)	50	0	100	%

Tab. 6.i

The valve opening parameter should be set based on the ratio between rated evaporator and valve cooling capacity (e.g. rated evaporator cooling capacity: 3 kW, rated valve cooling capacity: 10 kW, valve opening = 3/10 = 33%).

- If 100% capacity is required: Opening (%)= (Valve opening at start-up);
- If capacity required is less than 100% (capacity control): Opening (%)= (Valve opening at start-up) • (Current unit cooling capacity), where the current unit cooling capacity is sent to the driver via pLAN by the pCO controller. For stand-alone drivers this is always equal to 100%.



Note:

- this procedure is used to anticipate valve movement and bring it much closer to working position immediately after the unit is powered on;
- if there are problems with liquid return after the start of the refrigeration unit, or there are frequent unit on-off cycles, valve opening at start-up must be decreased. If there are low pressure problems after starting the refrigeration unit, the valve opening must be increased.

Positioning (change cooling capacity)

In practice, the valve is re-positioned starting from the current position in proportion to how much the unit cooling capacity has increased or decreased, in percentage terms. On reaching the calculated position, irrespective of how long it takes (variable according to the type of valve and the actual position), there will be a constant 5 second delay, after which control resumes.

Note: if it is not possible to have the information on the change in unit cooling capacity, this will be always be considered as operating at 100% and therefore the procedure will never be used. In this case, the PID control needs to be more reactive (see Control), so as to respond promptly to variations in load that are not communicated to the driver.

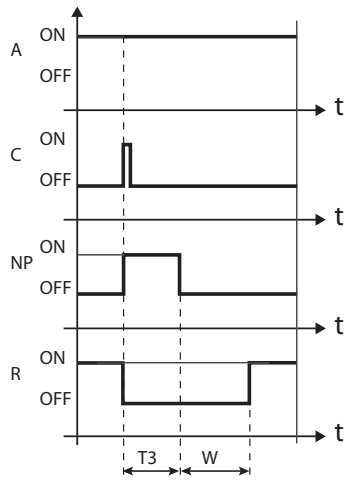

Fig. 6.au

Legenda:

A	Control request	T3	Re-positioning time
C	Change in capacity	W	Wait
NP	Re-positioning	t	Time
R	Control		

6.6.8 Unit of measure

pRack pR300 can manage two units of measure, the international system and Imperial.

Note: the temperature and pressure units of measure can be changed from °C, barg to °F, psig only during start-up; mixed configurations are not allowed, for example °F and barg.

6.6.9 Sign of life

pRack pR300 can manage a digital output acting as a sign of life, activated when pRack pR300 is powered up.

This output remains active while the controller is working correctly and highlights any hardware faults.

The Signal can be configured in main menu branch B.a.c.

6.6.10 Liquid non-return

pRack pR300 can manage a digital output with the meaning of liquid non-return. This normally active output is deactivated when all the compressors are off and no compressor can be started due to alarms or time settings, despite the control request, or when the unit is OFF. As soon as at least one compressor is enabled to start, the output is deactivated, allowing management of a liquid non-return valve. The function can be configured in main menu branch C.a.g/C.b.g.

6.6.11 Interaction with pLoads

pRack pR300 can interact with the pLoads controller, which manages power using a load cut-off function.

Interaction can be enabled and the related parameters set from main menu branch C.a.d and C.b.d.

Interaction between pRack pR300 and pLoads uses digital inputs or the supervisor. The digital inputs have higher priority, therefore if a digital input is not active, the corresponding action is not produced even if requested by the supervisor.

Two of the free digital inputs on pRack pR300 can be configured for connection to two pLoads outputs, with each input being assigned one of the following actions:

- No action. Activation of the digital input has no influence on control.
- Capacity limited to the current value. Activation of the digital input limits the maximum control request; capacity can be reduced from this value by the controller, but cannot exceed the current value at the moment the digital input was activated for the entire time it remains active, as shown in the figure:

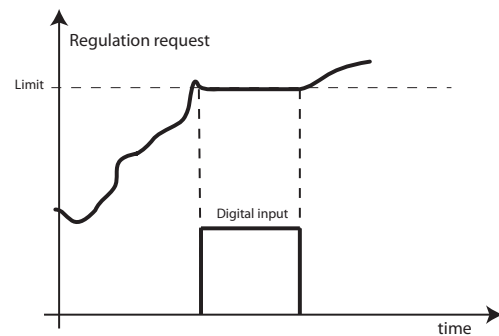

Fig. 6.al

- Capacity limited to a % value, settable by parameter. As in the previous case, the control request is limited at the top end, however to a fixed value set by parameter.
- Decrease capacity by a % value, settable by parameter. Activation of the digital input reduces the control request by a fixed value set by parameter, as shown in the figure:

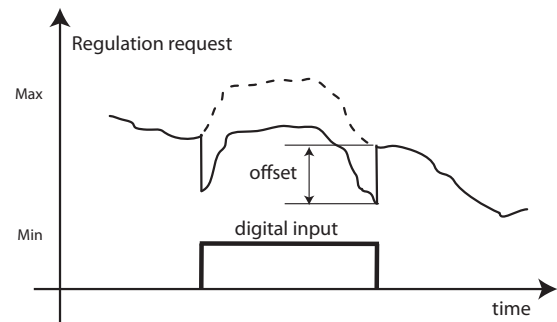

Fig. 6.am

- By suitably setting this parameter based on system configuration, one compressor can be shut down; for example if there are three compressors, by setting the decrease to 33%, activation of the input stops one of the three compressors. Compressor shutdown and restart respect the safety times.

The digital inputs configured are common to both lines, while for each line a different action can be associated with the same digital input.

In any case, the previous actions do not interfere with the pRack pR300 safety features, which always have priority over the actions set from digital input.

Moreover, a suction pressure safety threshold has been introduced, therefore the actions associated with the inputs are only enabled if the pressure does not exceed this threshold (settable by parameter). After the pLoads action has been disabled, it is necessary that the suction pressure returns below the safety threshold for a setted time (higher than 30 s), before restoring the interaction between the two devices, so to the regulation can be stabilize.

6.6.12 Power consumption

pRack pR300 can calculate power consumption for the current day and the previous day. The calculation can be enabled and the related parameters set from main menu branch C.a.d and C.b.d.

To calculate power consumption, the current draw is measured via an analogue input, while the type of load, rated voltage and displacement can be set by parameter. The calculation starts at 00:00 every day and continues until 24:00, when the value from the previous day is overwritten with the new calculated value. The supervisory system can use the two values, current day's consumption and previous day's consumption, for power consumption analysis.

6.7 Settings

6.7.1 Clock

pRack pR300 features an internal clock with backup battery that keeps the time and date for all related functions (see Chapter 2 for details relating to the hardware).

The date on pRack pR300 can be set as follows:

- day, month, year (dd/mm/yy)
- month, day, year (mm/dd/yy)
- year, month, day (yy/mm/dd)

The current date and time can be set, the day of the week corresponding to set date displayed, plus changeover to daylight saving can be enabled by setting the changeover date and the deviation.

The related parameters can be set during start-up or in main menu branch Fa.

 **Note:** the date and time are managed on pRack boards with addresses 1 and 2; on power-up and whenever the pLAN network is reconnected, the software on pRack synchronises the settings on board 2, sending the date and time set on board 1.

If the clock card is not operating, an alarm is generated and the functions relating to the time bands described in the following paragraph are not available.

6.7.2 Time bands

pRack pR300 allows the operating seasons, the closing periods and weekends to only be set once, and consequently these are common to all the system functions.

As well as these settings, each function can be associated with a weekly scheduler, setting up to 4 different daily activation bands for each day of the week. For each time band, the start and end time can be set and settings made can be copied to the others days of the week.

The priority of the schedulers, from lowest to highest, is:

- weekly scheduler
- closing periods
- special days

For example, if the weekly scheduler requires activation of a function, yet a closing period is in progress, and requires deactivation of the same function, then the function is deactivated. The following functions allow the setting of time bands:

- Split-condenser: the function is active only based on the operating seasons, and consequently special days, closing periods and daily time bands are ignored.
- Silencer: the function is only active with daily time bands, there is no link to operating seasons, special days and closing periods
- Heat recovery: the function is active with daily time bands, special days and closing periods, no link to operating seasons. The link to the general scheduler can be disabled, considering the time bands only.
- Set point compensation: active with operating seasons, special days, closing periods and daily time bands (two different offsets).

- Generic functions: the generic scheduling function is active with the operating seasons, special days, closing periods and daily time bands. Operation of the generic functions can be separated from the generic scheduler, considering the daily time bands only.

For details on the functions that use time bands, see the corresponding paragraphs.

6.8 Managing the default values

pRack pR300 can manage two different sets of default values:

- user defaults
- Carel defaults

The two functions can be activated in main menu branch I.d.

 **Important:** after having reset the default values, the pRack pR300 board need to be switched off and on again.

6.8.1 Saving and resetting the user default values

pRack pR300 can save the exact configuration set by the user inside the instrument, allowing it to be recalled at any time.

All the set values are saved, therefore loading user defaults restores the exact same conditions that the pRack pR300 controller was in when the data were saved.

 **Note:** only one user default configuration can be saved, therefore when the data is next saved, this overwrites the previous data.

 **Important:**

- the Carel default reset procedure totally deletes the pRack pR300 permanent memory, and consequently is an irreversible operation;
- the user values cannot be reset after updating the software on the pRack pR300, nonetheless see Chapter 10 for details on how to save the parameters for versions different of the software.

6.8.2 Resetting the Carel default values

The Carel default values are shown in the Parameters table in Chapter 7.





The values pre-set by Carel can be installed at any time, restoring the pRack pR300 default settings, and requiring the startup procedure described in Chapter 4 to be repeated.

 **Important:** the Carel default reset procedure totally deletes the pRack pR300 permanent memory, and consequently is an irreversible operation; nonetheless, the user settings can still be restored if these have already been saved. Given that pRack pR300, following the installation of the Carel default values requires the startup procedure to be repeated, select the first pre-configuration and then restore the user defaults.

 **Note:** to complete a new configuration procedure as described in Chapter 4, first restore the Carel default values.

7. PARAMETERS TABLE

 "Mask index": indicates the unique address of each screen and consequently the path needed to reach the parameters available on this screen; for example, to reach the parameters corresponding to the suction pressure probe with mask index Bab01, proceed as follows:

 Main menu  B. In./Out.  a. Status  b. Analog. in.

Below is the table of the parameters that can be displayed on the terminal. The values indicated with '---' are not Significant or are not set, while the values indicated with '...' may vary according to the configuration, with the possible options visible on the user terminal. A row of '...' means that there are a series of parameters Similar to the previous ones.

 **Note:** Not all the screens and parameters shown in the table are always visible or can be set, the screens and parameters that are visible or can be set depend on the configuration and the access level.

Mask index	Description on terminal	Description	Default	UOM	Values	
Main screen						
Main screen (display only)	---	Hours and minutes	
	---	Date	
	L1-Suction	Suction pressure or temperature (configurable, line 1)	---(**)	
	L1-Condenser	Condensing pressure or temperature (configurable, line 1)	---(**)	
	L1-SHeat	Superheat (configurable, line 1)	---(**)	
	L1-Suct. temp.	Suction temperature (configurable, line 1)	---(**)	
	L1-Dis. temp.	Discharge temperature (configurable, line 1)	---(**)	
	L1-Auxiliary	Auxiliary pressure or temperature (configurable, line 1)	---(**)	
	L2-Suction	Suction pressure or temperature (configurable, line 2)	---(**)	
	L2-Condenser	Condensing pressure or temperature (configurable, line 2)	---(**)	
	L2-SHeat	Superheat (configurable, line 2)	---(**)	
	L2-Suct. temp.	Suction temperature (configurable, line 2)	---(**)	
	L2-Dis. temp.	Discharge temperature (configurable, line 1)	---(**)	
	L2-Auxiliary	Auxiliary pressure or temperature (configurable, line 2)	---(**)	
	EVD1-Condenser	Condensing pressure or temperature (configurable on Driver 1, line 2)	---(**)	
	EVD2-Condenser	Condensing pressure or temperature (configurable on Driver 2, line 2)	---(**)	
	---	Unit status (with unit OFF)	---	---	Unit OFF from Alarm	
					Unit OFF from blackout	
					Unit OFF from supervisor	
					Unit OFF from default	
					Unit OFF from digital IN	
					Unit OFF from keypad	
					Unit OFF manual mode	
	---		Number of compressors on line 1(with unit ON, configurable)	---	---	0...12
	---		Compressor activation percentage on line 1 (with unit ON, configurable)	---	%	0...100
	---		Number of compressors on line 2(with unit ON, configurable)	---	---	0...12
	---		Compressor activation percentage on line 2 (with unit ON, configurable)	---	%	0...100
	---		Number of fans on line 1 (with unit ON, configurable)	---	---	0...16
	---		Fan activation percentage on line 1 (with unit ON, configurable)	---	%	0...100
	---		Number of fans on line 2 (with unit ON, configurable)	---	---	0...16
	---		Fan activation percentage on line 2 (with unit ON, configurable)	---	%	0...100
	Secondary screen (display only)	---	Hours and minutes
---		Date	
L1-Suction		Suction pressure or temperature (configurable, line 1)	---(**)	
L1-Condenser		Condensing pressure or temperature (configurable, line 1)	---(**)	
L1-SHeat		Superheat (configurable, line 1)	---(**)	
L1-Suct. temp.		Suction temperature (configurable, line 1)	---(**)	
L1-Dis. temp.		Discharge temperature (configurable, line 1)	---(**)	
L1-Auxiliary		Auxiliary pressure or temperature (configurable, line 1)	---(**)	
L2-Suction		Suction pressure or temperature (configurable, line 2)	---(**)	
L2-Condenser		Condensing pressure or temperature (configurable, line 2)	---(**)	
L2-SHeat		Superheat (configurable, line 2)	---(**)	
L2-Suct. temp.		Suction temperature (configurable, line 2)	---(**)	
L2-Dis. temp.		Discharge temperature (configurable, line 1)	---(**)	
L2-Auxiliary		Auxiliary pressure or temperature (configurable, line 2)	---(**)	
EVD1-Condenser		Condensing pressure or temperature (configurable on Driver 1, line 2)	---(**)	
EVD2-Condenser		Condensing pressure or temperature (configurable on Driver 2, line 2)	---(**)	
---		Unit status (with unit OFF)	---	---	Unit OFF from Alarm	
					Unit OFF from blackout	
					Unit OFF from supervisor	
					Unit OFF from default	
					Unit OFF from digital IN	
					Unit OFF from keypad	
					Unit OFF manual mode	
---			Number of compressors on line 1(with unit ON, configurable)	---	---	0...12
---			Compressor activation percentage on line 1 (with unit ON, configurable)	---	%	0...100
---			Number of compressors on line 2(with unit ON, configurable)	---	---	0...12
---			Compressor activation percentage on line 2 (with unit ON, configurable)	---	%	0...100
---			Number of fans on line 1 (with unit ON, configurable)	---	---	0...16
---			Fan activation percentage on line 1 (with unit ON, configurable)	---	%	0...100
---			Number of fans on line 2 (with unit ON, configurable)	---	---	0...16
---			Fan activation percentage on line 2 (with unit ON, configurable)	---	%	0...100

Mask index	Display description	Description	Default	UOM	Values
U A.Unit_status					
Aa01 (display only)	Pressure	Suction pressure (line 1)	--- (**)
	Sat.temp.	Saturated suction temperature (line 1)	--- (**)
	Act.setpoint	Effective set point for pressure control (with compensation applied, line 1)	... (**) (**)
	Differential	Control differential for pressure control (line 1)	... (**) (**)
Aa02 (display only)	Pressure	Suction pressure (line 1)	--- (**)
	Sat.temp.	Saturated suction temperature (line 1)	--- (**)
	Act.setpoint	Effective set point for temperature control (with compensation applied, line 1)	... (**) (**)
	Differential	Control differential for temperature control (line 1)	... (**) (**)
Aa03 (display only)	Actual/req.	Capacity delivered/capacity required for suction line (line 1)	---	%	0/0 ... 100/100
	Reg.status	Control status (according to the type of control set, line 1)	---	---	Stop Increases Decrease Standby Operating Timings Alarms
	Reg.type	Compressor control type (line 1)	Neutral zone	---	Proportional band Neutral zone
	Setpoint	Effective suction pressure set point (with compensation applied, line 1)	... (**) (**)
Aa04 (display only)	C01, C02, ...C12	Time remaining to next compressor start (line 1)	---	s	0...32000
	C01	Capacity delivered by compressor 1 on line 1 (a "!" to the right of the value means that some form of compressor capacity override is active, e.g. times, alarms, start-up procedure)	---	%	0...100

	C12	Capacity delivered by compressor 12 (line 1)	---	%	0...100
Aa05 (display only)	Temperature	Suction temperature (line 1)	--- (**)
	Superheat	Superheat (line 1)	--- (**)
Aa11 (display only)	Disch.1	Discharge temperature, compressor 1 (line 1)	--- (**)
	---
Aa13 (display only)	Liq.inj.1: DO	Number of digital output associated and status of liquid injection/ economizer (*) compressor 1 (line 1)	---	...	0...29 ON / OFF
	---
Aa13 (display only)	Liq.inj.6: DO	Number of digital output associated and status of liquid injection/ economizer (*) compressor 6 (line 1)	---	...	0...29 ON / OFF
	---
Aa15 (display only)	Discharge temperature	Digital ScrollTM compressor discharge temperature (line 1)	--- (**)
	Cap.reduction	Digital ScrollTM compressor capacity reduction in progress (line 1)	---	---	NO / YES
	Oil sump temp.	Digital ScrollTM compressor oil sump temperature (line 1)	--- (**)
	Oil status	Digital ScrollTM compressor oil dilution status (line 1)	---	---	Ok Dilute
Aa16 (display only)	Status	Digital ScrollTM compressor operating status (line 1)	---	---	Off Start up On Alarm Off by time On by time Mod. manual In pump down
	Countdown	Digital ScrollTM compressor time count (line 1)	---	s	0...999
	Compr.	Digital ScrollTM compressor status (line 1)	---	---	OFF ON
	Valve	Digital ScrollTM valve status(line 1)	---	---	OFF ON
Aa20 (display only)	Requested cap.	Digital ScrollTM compressor capacity required (line 1)	---	%	0...100
	Current capac.	Digital ScrollTM compressor effective capacity (line 1)	---	%	0...100
Aa21 (display only)	Pressure	Condensing pressure (line 1)	--- (**)
	Sat.temp.	Saturated condensing temperature (line 1)	--- (**)
	Act.setpoint	Effective set point for pressure control (with compensation applied, line 1)	... (**) (**)
	Differential	Control differential for pressure control (line 1)	... (**) (**)
Aa22 (display only)	Pressure	Condensing pressure (line 1)	--- (**)
	Sat.temp.	Saturated condensing temperature (line 1)	--- (**)
	Act.setpoint	Effective set point for temperature control (with compensation applied, line 1)	... (**) (**)
	Differential	Control differential for temperature control (line 1)	... (**) (**)
Aa23 (display only)	Actual/req.	Capacity delivered/capacity required for condenser line (line 1)	---	%	0/0 ... 100/100
	Status	Control status (according to the type of control set, line 1)	---	---	Stop Increase Decrease Stand-by Operating Timings Alarms
	Reg.type	Condenser control type (line 1)	Neutral zone	---	Proportional band Neutral zone
	Setpoint	Condenser control effective set point (with compensation applied, line 1)	... (**) (**)
Aa24 (display only)	F1	Power output of fan 1 on line 1 (a "!" to the right of the value means that some form of power override is active)	---	%	0...100
	---
	F8	Power output of fan 8 on line 1 (a "!" to the right of the value means that some form of power override is active)	---	%	0...100
Aa25 (display only)	F9	Power output of fan 9 on line 1 (a "!" to the right of the value means that some form of power override is active)	---	%	0...100
	---
Aa31 (display only)	F16	Power output of fan 16 on line 1 (a "!" to the right of the value means that some form of power override is active)	---	%	0...100
	---
Aa32 (display only)	Discharge temperature	Discharge temperature (line 1)	--- (**)
	External temperature	Outside temperature (line 1)	--- (**)
	Pressure	Suction pressure (line 2)	--- (**)
	Sat.temp.	Saturated suction temperature (line 2)	--- (**)
Aa32 (display only)	Act.setpoint	Effective set point for pressure control (with compensation applied, line 2)	... (**) (**)
	Differential	Control differential for pressure control (line 2)	... (**) (**)
Aa32 (display only)	Pressure	Suction pressure (line 2)	--- (**)
	Sat.temp.	Saturated suction temperature (line 2)	--- (**)
Aa32 (display only)	Act.setpoint	Effective set point for temperature control (with compensation applied, line 2)	... (**) (**)
	Differential	Control differential for temperature control (line 2)	... (**) (**)

Mask index	Display description	Description	Default	UOM	Values
Aa33 (display only)	Actual/req.	Capacity delivered/capacity required for suction line (line 2)	---	%	0/0 ... 100/100
	Status	Control status (according to the type of control set, line 2)	---	---	Stop Increase Decrease Stand-by Operating Timings Alarms
	Reg.type	Compressor control type (line 2)	Neutral zone	---	Proportional band Neutral zone
Aa34 (display only)	Setpoint	Effective suction pressure set point (with compensation applied, line 2)	... (**) (**)
	C01, C02, ...C12	Time remaining to next compressor start (line 2)	---	s	0...32000
	C01	Capacity delivered by compressor 1 on line 2 (a "!" to the right of the value means that some form of compressor capacity override is active, e.g. times, alarms, start-up procedure)	---	%	0...100
Aa05 (display only)
	C12	Capacity delivered by compressor 12 (line 2)	---	%	0...100
Aa41 (display only)	Temperature	Suction temperature (line 2)	--- (**)
	Superheat	Superheat (line 2)	--- (**)
Aa43 (display only)	Disch.1	Discharge temperature, compressor 1 (line 2)	--- (**)

Aa45 (display only)	Disch.6	Discharge temperature, compressor 6 (line 2)	--- (**)

Aa46 (display only)	Liq.inj.1: DO	Number of digital output associated and status liquid injection compr. 1 (line 2)	---	...	0...29 ON / OFF

Aa45 (display only)	Liq.inj.6: DO	Number of digital output associated and status liquid injection compr. 6 (line 2)	---	...	0...29 ON / OFF

Aa45 (display only)	Discharge temperature	Digital ScrollTM compressor discharge temperature (line 2)	--- (**)
	Cap.reduction	Digital ScrollTM compressor capacity reduction in progress (line 2)	---	...	NO / YES
Aa45 (display only)	Oil sump temp.	Digital ScrollTM compressor oil sump temperature (line 2)	--- (**)
	Oil status	Digital ScrollTM compressor oil dilution status (line 2)	---	...	Ok Dilute
Aa46 (display only)	Status	Digital ScrollTM compressor operating status (line 2)	---	---	Off Start up On Alarm Off by time On by time Manual mod. In pump down
	Countdown	Digital ScrollTM compressor time count (line 2)	---	s	0...999
Aa50 (display only)	Compr.	Digital ScrollTM compressor status (line 2)	---	---	OFF / ON
	Valve	Digital ScrollTM valve status (line 2)	---	---	OFF / ON
Aa50 (display only)	Requested cap.	Digital ScrollTM compressor capacity required (line 2)	---	%	0...100
	Current capac.	Digital ScrollTM compressor effective capacity (line 2)	---	%	0...100
Aa50 (display only)	Pressure	Condensing pressure (line 2)	--- (**)
	Sat.temp.	Saturated condensing temperature (line 2)	--- (**)
Aa51 (display only)	Act.setpoint	Effective set point for pressure control (with compensation applied, line 2)	... (**) (**)
	Differential	Control differential for pressure control (line 2)	... (**) (**)
Aa51 (display only)	Pressure	Condensing pressure (line 2)	--- (**)
	Sat.temp.	Saturated condensing temperature (line 2)	--- (**)
Aa51 (display only)	Act.setpoint	Effective set point for temperature control (with compensation applied, line 2)	... (**) (**)
	Differential	Control differential for temperature control (line 2)	... (**) (**)
Aa52 (display only)	Actual/req.	Capacity delivered/capacity required for condenser line (line 2)	---	%	0/0 ... 100/100
	Reg.status	Control status (according to the type of control set, line 2)	---	---	Stop Increase Decrease Stand-by Operating Timings Alarms
Aa52 (display only)	Reg.type	Condenser control type (line 2)	Neutral zone	---	Proportional band Neutral zone
	Setpoint	Condenser control effective set point (with compensation applied, line 2)	... (**) (**)
Aa53 (display only)	F1	Power output of fan 1 on line 2 (a "!" to the right of the value means that some form of power override is active)	---	%	0...100

Aa53 (display only)	F8	Power output of fan 8 on line 2 (a "!" to the right of the value means that some form of power override is active)	---	%	0...100

Aa54 (display only)	F9	Power output of fan 9 on line 2 (a "!" to the right of the value means that some form of power override is active)	---	%	0...100

Aa54 (display only)	F16	Power output of fan 16 on line 2 (a "!" to the right of the value means that some form of power override is active)	---	%	0...100

Aa55 (display only)	Discharge temperature	Discharge temperature (line 2)	--- (**)
	External temperature	Outside temperature (line 2)	--- (**)
Aa60 (display only)	Status,curr.	Effective status of screw compressor 1 with stepped modulation	---	---	Off Start up Stage1 Stage 2 Stage 3 Stage 4
	Status, req.	Status required for the screw compressor 1 with stepped modulation	---	---	Off Start up Stage1 Stage 2 Stage 3 Stage 4
Aa60 (display only)	Minimum on time	Countdown for minimum on time screw comp. 1 with stepped modulation	---	s	0...999
	Min.off/starts	Countdown for minimum off time or wait between successive starts screw comp. 1 with stepped modulation	---	s	0...999
Aa61 (display only)	Next step	Countdown for next step activation screw comp. 1 with stepped modulation	---	s	0...999
	Status	Effective status of screw compressor 1 with continuous capacity modulation	---	---	Off Start up Norm. operating Shut down
Aa61 (display only)	Shut down countd.	Screw comp. 1 off time with continuous capacity modulation	---	s	0...999
	Max.pow.countdown	Countdown for minimum off time or wait between successive starts screw comp. 1 with continuous capacity modulation	---	s	0...999
Aa61 (display only)	Min.on countdown	Countdown to start screw comp. 1 with continuous capacity modulation	---	s	0...999

Mask index	Display description	Description	Default	UOM	Values
Aa62 (display only)	Status,curr.	Effective status of screw compressor 2	---	---	Off Stage 2 Start up Stage 1 Stage 4
	Status, req.	Status required for the screw compressor 2	---	---	Off Stage 2 Start up Stage 1 Stage 4
	Minimum on time	Countdown for minimum on time screw comp. 2	---	s	0...999
	Min.off/starts	Countdown for minim. off time or wait between successive starts screw comp. 2	---	s	0...999
	Next step	Countdown for next step activation screw comp. 2	---	s	0...999
Aa70 (display only)	Zone	Envelope zone for screw compressor 1	---	---	0...14
	Max admit.time	Maximum duration allowed in the zone	---	min	0...999
	Countdown	Countdown	---	s	0...32000
	Max admit.power	Maximum capacity allowed in the zone	---	%	0...100
Aa71 (display only)	Startup status	Start-up status for screw compressor 1	---	---	Off Compressor on Intermediate interval Final interval Compressor off Restart Alarm
	N° startup restart	Number of restarts	---	---	0...99
Aa72 (display only)	Err.code	Type of error in envelope definition	---	---	No error / Env. def. inconsist..
	Al.code	Type of alarm activated	---	---	No Alarm Max time elapsed Zone not allowed Max. no. of restarts
	Envel.def.error code	Type of error in selection of predefined envelope	---	---	No error Comp. not supported Gas type not allowed
Aaan (display only)	Reg.var.	Control variable value for generic stage function 1	--- (**)
	Enable	Enabling variable status for generic stage function 1	---	---	Not active active
	Setpoint	Control set point for generic stage function 1	--- (**)
	Differential	Control differential for generic stage function 1	--- (**)
	Mode	Control mode for generic stage function 1 (direct or reverse)	---	---	D, R
...	---	---	Not active / Active
Aaar (display only)	Reg.var.	Control variable value for the generic stage function 5	--- (**)
	Enable	Enabling variable status for the generic stage function 5	---	---	Not active / Active
	Setpoint	Control set point for the generic stage function 5	--- (**)
	Differential	Control differential for the generic stage function 5	--- (**)
	Mode	Control mode for the generic stage function 5 (direct or reverse)	---	---	D, R
...	---	---	Not active / Active
Aaas (display only)	Reg.variable	Control variable value for generic modulating function 1	--- (**)
	Enable	Enabling variable status for generic modulating function 1	---	---	Not active / Active
	Setpoint	Control set point for generic modulating function 1	--- (**)
	Differential	Control differential for generic modulating function 1	--- (**)
...	---	---	D, R
Aaat (display only)	Status	Status of generic modulating function 1	---	%	0.0...100.0
	Reg.variable	Control variable value for generic modulating function 2	--- (**)
	Enable	Enabling variable status for generic modulating function 2	---	---	Not active / Active
	Setpoint	Control set point for generic modulating function 2	--- (**)
...	---	---	... (**)
Aaau (display only)	Differential	Control differential for generic modulating function 2	---	---	D, R
	Status	Status of generic modulating function 2	---	%	0.0...100.0
	Reg.variable	Control variable status for generic alarm function 1	---	---	Not active / Active
	Enable	Enabling variable status for generic alarm function 1	---	---	Not active / Active
Aaav (display only)	Type	Type of alarm for generic alarm function 1	---	---	Light / Serious
	Delay time	Control differential for generic alarm function 1	---	s	0...9999
	Status	Status of generic alarm function 1	---	---	Not active / Active
	Reg.variable	Control variable status for generic alarm function 2	---	---	Not active / Active
Aaaw (display only)	Enable	Enabling variable status for generic alarm function 2	---	---	Not active / Active
	Type	Type of alarm for generic alarm function 2	---	---	Light / Serious
	Delay time	Control differential for generic alarm function 2	---	s	0...9999
	Status	Status of generic alarm function 2	---	---	Not active / Active
Aaax (display only)	Weekday	Day of the week	---	---	Monday, ..., Sunday
	TB1: --:-- -> --:--	Enabling and definition of time band 1: start hour and minutes, end hour and minutes for the generic scheduling function	---
	---	---	...
	TB4: --:-- -> --:--	Enabling and definition of time band 4: start hour and minutes, end hour and minutes for the generic scheduling function	---
Aaay (display only)	Status	Status of generic scheduling function	---	---	Not active / Active
	Status	Status of heat recovery function (line 1)	---	---	OFF / ON
	Heat recl. temp.	Heat recovery temperature (line 1)	--- (**)
	An.OUT modulad.	Status of modulating heat recovery valve output (line 1)	---	---	0.0...100.0
Aaaz (display only)	HR Prevent	Status of prevention via heat recovery (line 1)	---	---	OFF / ON
	Status	Status of heat recovery function (line 2)	---	---	OFF / ON
	Heat recl. temp.	Heat recovery temperature (line 2)	--- (**)
	An.OUT modulad.	Status of modulating heat recovery valve output (line 2)	---	---	0.0...100.0
Aaa1 (display only)	HR Prevent	Status of prevention via heat recovery (line 2)	---	---	OFF / ON
	Status	Status of ChillBooster device (line 1)	---	---	OFF / ON
	Ext.temp.	Outside temperature (line 1)	--- (**)
	Ext.temp.thr.	ChillBooster activation threshold (line 1)	--- (**)
Aaa1 (display only)	Time fan 100%	Number of minutes elapsed with fans at 100/number of min. allowed (line 1)	---	min	0...999/0...999
	Status	Status of ChillBooster device (line 2)	---	---	OFF / ON
	Ext.temp.	Outside temperature (line 2)	--- (**)
	Ext.temp.thr.	ChillBooster activation threshold (line 2)	--- (**)
Aaa1 (display only)	Time fan 100%	Number of minutes elapsed with fans at 100/number of minutes allowed (line 1)	---	min	0...999/0...999

Mask index	Display description	Description	Default	UOM	Values	
Aaa2 (display only)	Cond.temp.	Saturated condensing temperature (line 1)	--- (**)	
	Liquid Temp.	Liquid temperature (line 1)	--- (**)	
	Subcooling	Subcooling (line 1)	--- (**)	
	Status	Status of subcooling function (line 1)	---	---	Open / Closed	
Aaa4 (display only)	Action 1	Description and status of the reduced power consumption action associated with the first digital input from pLoads (line 1)	---	---	OFF / ON	
	Action 2	Description and status of the reduced power consumption action associated with the second digital input from pLoads (line 1)	---	---	OFF / ON	
Aaa5 (display only)	Action 1	Description and status of the reduced power consumption action associated with the first digital input from pLoads (line 2)	---	---	OFF / ON	
	Action 2	Description and status of the reduced power consumption action associated with the second digital input from pLoads (line 2)	---	---	OFF / ON	
Aaa6 (display only)	Current	Value read by the current sensor (line 1)	---	A	0 to 999.9	
	Inst. power	Instant power calculated (line 1)	---	kW	0 to 100	
	Power today	Power consumption during the current day (line 1)	---	kWh	0 to 32767	
	Previous User setp.	Power consumption during the previous day (line 1) User-defined set point for suction pressure control, proportional control (line 1)	---	kWh	0 to 32767 ... (**)	
Ab01 (display only)	Actual.setpoint	Effective set point for suction pressure control, proportional control (with compensation applied, line 1)	--- (**)	
	Diff.	Suction pressure control differential, proportional control (line 1)	--- (**)	
Ab02 (display only)	User setp.	User-defined set point for suction pressure control, proportional control (line 1)	--- (**)	
	Actual.setpoint	Effective set point for suction pressure control, proportional control (with compensation applied, line 1)	--- (**)	
	Neutral zone	Neutral zone for suction pressure control (line 1)	--- (**)	
	Incr.diff.	Increase differential for suction pressure control, neutral zone control (line 1)	--- (**)	
	Decr.diff.	Decrease differential for suction pressure control, neutral zone control (line 1)	--- (**)	
Ab03 (display only)	User setp.	User-defined set point for suction pressure control, proportional control (line 2)	--- (**)	
	Actual.setp.	Effective set point for suction pressure control, proportional control (with compensation applied, line 2)	--- (**)	
	Diff.	Suction pressure control differential, proportional control (line 2)	--- (**)	
Ab04 (display only)	User setp.	User-defined set point for suction pressure control, proportional control (line 2)	--- (**)	
	Actual.setp.	Effective set point for suction pressure control, proportional control (with compensation applied, line 2)	--- (**)	
	Neutral zone	Neutral zone for suction pressure control (line 2)	--- (**)	
	Incr.diff.	Increase differential for suction pressure control, neutral zone control (line 2)	--- (**)	
	Decr.diff.	Decrease differential for suction pressure control, neutral zone control (line 2)	--- (**)	
Ab05 (display only)	User setp.	User-defined set point for condensing pressure control, proportional control (line 1)	--- (**)	
	Actual.setp.	Effective set point for condensing pressure control, proportional control (with compensation applied, line 1)	--- (**)	
	Diff.	Condensing pressure control differential, proportional control (line 1)	--- (**)	
Ab06 (display only)	User setp.	User-defined set point for condensing pressure control, proportional control (line 1)	--- (**)	
	Actual.setp.	Effective set point for condensing pressure control, proportional control (with compensation applied, line 1)	--- (**)	
	Neutral zone	Neutral zone for condensing pressure control (line 1)	--- (**)	
	Incr.diff.	Increase differential for the condensing pressure control, neutral zone control (line 1)	--- (**)	
	Decr.diff.	Decrease differential for the condensing pressure control, neutral zone control (line 1)	--- (**)	
Ab07 (display only)	User setp.	User-defined set point for condensing pressure control, proportional control (line 2)	--- (**)	
	Actual.setp.	Effective set point for condensing pressure control, proportional control (with compensation applied, line 2)	--- (**)	
	Diff.	Condensing pressure control differential, proportional control (line 2)	--- (**)	
Ab08 (display only)	User setp.	User-defined set point for condensing pressure control, proportional control (line 2)	--- (**)	
	Actual setp.	Effective set point for condensing pressure control, proportional control (with compensation applied, line 2)	--- (**)	
	Neutral zone	Neutral zone for condensing pressure control (line 2)	--- (**)	
	Incr.diff.	Increase differential for the condensing pressure control, neutral zone control (line 2)	--- (**)	
	Decr.diff.	Decrease differential for the condensing pressure control, neutral zone control (line 2)	--- (**)	
Ab12	Setpoint	Setpoint without compensation (suction line 1)	3,5 barg (**)	
Ab13	Setpoint	Setpoint without compensation (condenser line 1)	12,0 barg (**)	
Ab14	Setpoint	Setpoint without compensation (suction line 2)	3,5 barg (**)	
Ab15	Setpoint	Setpoint without compensation (condenser line 2)	12,0 barg (**)	
Ac01	Status	Unit status (display only)	Off from keypad	---	Waiting.. Unit On/ Off from alarm Off from blackout Off from BMS	Off by default Off by DIN Off from keypad Manual op. Prevent HP
	---	On-Off from keypad (line 1)	OFF	---	OFF / ON	

Mask index	Display description	Description	Default	UOM	Values
Ac02	L1:	Unit status (display only)	Off from keypad	---	...(See above Ac01)
	L2:				
	---	On-Off from keypad (line 1)	OFF	---	OFF / ON
Ac03	---	On-Off from keypad (line 2)	OFF	---	OFF / ON
	Enable of unit OnOff By digit input	Enable unit On/Off from digit input (line 1)	NO	---	NO / YES
	By supervisor	Enable unit On/Off from supervisor (line 1)	NO	---	NO / YES
Ac04	By black out	Enable unit On/Off from black out (line 1)	NO	---	NO / YES
	Unit on delay after blackout	System on delay after black out (line 1)	0	s	0...999

Ac06	Enable of unit OnOff By digit input	Enable unit On/Off from digit input (line 2)	NO	---	NO / YES
	By supervisor	Enable unit On/Off from supervisor (line 2)	NO	---	NO / YES
	By black out	Enable unit On/Off from black out (line 2)	NO	---	NO / YES
Ac07	Unit on delay after blackout	System on delay after black out (line 2)	0	s	0...999

Mask index	Display Description	Description	Default	UOM	Values
------------	---------------------	-------------	---------	-----	--------

I/O B. Input, output (the I/Os available depend on the selected configuration, the following are just some examples. For the complete list of I/O positions available see Appendix A.5)

Baa02	DI	Alarm 1 for compressor 1 DI position (line 1)	03	---	---, 01...18, B1...B10 (****)
	Status (display only)	Status of alarm 1 for compressor 1 DI (line 1)	---	---	Closed Open
	Logic	Logic of alarm 1 for compressor 1 DI (line 1)	NC	---	NC / NO
...	Function (display only)	Alarm 1 for compressor 1 function status (line 1)	---	---	Not active / Active
	---	---	---	---	---
	---	Suction pressure probe position (line1)	B1	---	---, B1...B10 (****)
Bab01	---	Suct pressure probe type (line 1)	4-20mA	---	---
	---	---	---	---	0-1V - 0-10V- 4-20mA- 0-5V
	---	Suction pressure value (line 1)	---	---	... (**)
	Upper value	Suct pressure maximum value (line 1)	7,0 barg	---	... (**)
	Lower value	Suct pressure minimum value (line 1)	-0,5 barg	---	... (**)
	Calibration	Suction pressure probe adjustment (line 1)	0,0 barg	---	... (**)
Bac02	---	---	---	---	---
	Line relay DO	Compressor 1 line DO position and status (On/Off) display (line 1)	---	---	---, 01...29 (****)
	Part winding DO/Star relay DO (*)	Compressor 1 part winding or star DO position and status (On/Off) display (line 1)	---	---	---, 01...29 (****)
Bac03	---/ Delta relay DO (*)	Compressor 1 delta DO position and status (On/Off) display (line 1)	---	---	---, 01...29 (****)
	Logic	DO logic to start compressor 1 (line 1)	NC	---	NC / NO
	Status (display only)	Compressor 1 unloader 1 DO position (line 1)	---	---	---, 01...29 (****)
	Logic	Logic for compressor 1 unloader 1 DO (line 1)	NO	---	NC / NO
Bad01	Function (display only)	Compressor 1 unloader 1 function status (line 1)	---	---	Not active / Active
	AO	Compressor modulating device AO position (line 1)	0	---	---, 01...06 (****)
	Type (****)	Type of output, PWM / phase control for compressor modulating device (line 1)	FCS1*-CON-VONOFF	---	FCS1*-CONVONOFF FCS3*-CONV010*
Bb01	Status (display only)	Modulating device output value (line 1)	0	%	0.0 to 100.0
	---	---	---	---	---
	Suction L1	Suction line 1 in manual mode	DIS	---	DIS / EN
	Suction L2	Suction line 2 in manual mode	DIS	---	DIS / EN
	Discharge L1	Condenser line 1 in manual mode	DIS	---	DIS / EN
Bba02	Discharge L2	Condenser line 2 in manual mode	DIS	---	DIS / EN
	Timeout	Manual mode duration after last key pressed	10	min	0...500
Bba16	Compressor 1 Force to	Manual stages request for compressor 1 (line 1)	OFF	---	OFF / ON 2 STAGES (*) 4 STAGES (*)
	---	---	---	---	---
Bba17	Compressor 12 Force to	Manual stage request for compressor 12 (line 1)	OFF	---	OFF / ON 2 STAGES (*) 4 STAGES (*)
	---	---	---	---	---
Bba18	Oil cool pump1 Force to	Manual operating status for oil cooling pump 1 (line 1)	OFF	---	OFF / ON
	Oil cool pump2 Force to	Manual operating status for oil cooling pump 2 (line 1)	OFF	---	OFF / ON
Bba20	Oil cool fan Force to	Manual operating status for oil cooling fan (line 1)	OFF	---	OFF / ON
	---	---	---	---	---
Bba34	Compressor 1 Force to	Manual stage request for compressor 1 (line 2)	OFF	---	OFF / ON 2 STAGES (*) 4 STAGES (*)
	---	---	---	---	---
Bba35	Compressor 12 Force to	Manual stage request for compressor 12 (line 2)	OFF	---	OFF / ON 2 STAGES (*) 4 STAGES (*)
	---	---	---	---	---
Bba37	Oil cool pump1 Force to	Manual operating status for oil cooling pump 1 (line 2)	OFF	---	OFF / ON
	Oil cool pump2 Force to	Manual operating status for oil cooling pump 2 (line 2)	OFF	---	OFF / ON
Bba38	Oil cool fan Force to	Manual operating status for oil cooling fan (line 2)	OFF	---	OFF / ON
	---	---	---	---	---
Bba53	Fan1 force	Manual operating status for fan 1 (line 1)	OFF	---	OFF / ON
	---	---	---	---	---
Bba53	Fan16 force	Manual operating status for fan 16 (line 1)	OFF	---	OFF / ON
	---	---	---	---	---

Mask index	Display Description	Description	Default	UOM	Values
Bba54	Heat reclaim pump force	Manual operating status for heat recovery pump (line 1)	OFF	---	OFF / ON
Bba55	ChillBooster force	Manual operating status for ChillBooster (line 1)	OFF	---	OFF / ON
Bba57	Fan1 force	Manual operating status for fan 1 (line 2)	OFF	---	OFF / ON
...
Bba72	Fan16 force	Manual operating status for fan 16 (line 2)	OFF	---	OFF / ON
Bba73	Heat reclaim pump force	Manual operating status for heat recovery pump (line 2)	OFF	---	OFF / ON
Bba74	ChillBooster force	Manual operating status for ChillBooster (line 2)	OFF	---	OFF / ON
Bbb05	Compressor 1 Force to	Manual continuous capacity request for compressor 1 (line 1)	0.0	%	0.0...100.0
Bbb06	Oil cool pump Force to	Manual request for oil cooling pump (line 1)	0.0	%	0.0...100.0
Bbb07	Compressor 1 Force to	Manual continuous capacity request for compressor 1 (line 2)	0.0	%	0.0...100.0
Bbb08	Oil cool pump Force to	Manual request for oil cooling pump (line 2)	0.0	%	0.0...100.0
Bbb09	Fan1 Force to	Manual continuous capacity request for fan 1 (line 1)	0.0	%	0.0...100.0
Bbb10	Heat reclaim pump force	Manual request for heat recovery pump (line 1)	0.0	%	0.0...100.0
Bbb11	Fan1 Force to	Manual continuous capacity request for fan 1 (line 2)	0.0	%	0.0...100.0
Bbb12	Heat reclaim pump force	Manual request for heat recovery pump (line 2)	0.0	%	v
Bc01	Test Dout Timeout	Enable DO test mode Test mode duration after last button pressed	NO 10	---	NO / YES 0...500
Bc02	Test Aout Timeout	Enable AO test mode Test mode duration after last button pressed	NO 10	---	NO / YES 0...500
Bca10	DO1	DO 1 logic for test DO 1 value for test	NO OFF	---	NO / NC OFF / ON
...	---	...
Bca26	DO29	DO 29 logic for test DO 29 value for test	NO OFF	---	NO / NC OFF / ON
Bcb10	AO1	AO 1 value for test	0.0	---	0.0...100.0
...	---	...
Bcb12	AO6	AO 6 value for test	0.0	---	0.0...100.0

Mask index	Display description	Description	Default	UOM	Values
------------	---------------------	-------------	---------	-----	--------

 C. Compressors(*) (The I/Os available depend on the selected configuration, the following are just some examples. For the complete list of I/O positions available see Appendix A.5)

Caa01	DI	Alarm 1 for compressor 1 DI position (line 1)	03	---	---,01...18,B1...B10(****)	
	Status (display only)	Status of alarm 1 for compressor 1 DI (line 1)	---	---	Closed / Open	
	Logic	Logic of alarm 1 for compressor 1 DI (line 1)	NC	---	NC / NO	
	Function (display only)	Alarm 1 for compressor 1 function status (line 1)	---	---	Not active / Active	
...	---	...	
Caa08	Line relay DO	Compressor 1 part winding or star DO position and status (On/Off) display (line 1)	...	---	---,01...29(****)	
	Part winding DO/Star relay DO (*)	Compressor 1 delta DO position and status (On/Off) display (line 1)	...	---	---,01...29(****)	
	---/ Delta relay DO (*)	Compressor 1 line DO position and status (On/Off) display (line 1)	...	---	---,01...29(****)	
	Logic	DO logic to start compressor 1 (line 1)	NC	---	NC / NO	
Caa09	DO	Unloader 1 for compressor 1 DO position (line 1)	---	---	---,01...29(****)	
	Status (display only)	Status of unloader 1 for compressor 1 DI (line 1)	---	---	Closed / Open	
	Logic	Logic of unloader 1 for compressor 1 DI (line 1)	NC	---	NC / NO	
	Function (display only)	Unloader 1 for compressor 1 function status (line 1)	---	---	Not active / Active	
...	---	...	
Caa14	AO	Compressor modulating device AO position (line 1)	0	---	---,01...06(****)	
	Type (****)	Type of output, PWM / phase control for compressor modulating device (line 1)	FCS1*-CON-VONOFF	---	FCS1*-CONVONOFF FCS3*-CONV010"	
	Status (display only)	Modulating device output value (line 1)	0	%	0.0...100.0	
...	---	...	
Caaal	---	Suction pressure probe position (line1)	B1	---	---,B1...B10(****)	
	---	Suct pressure probe type (line 1)	4-20mA	---	---	
	---	---	---	---	0-1V 0-10V 4-20mA 0-5V	
	---	(display only)	Suction temperature value (line 1)	---	...	(**)
	Upper value	Suct pressure maximum limit (line 1)	7,0 barg	(**)
	Lower value	Suct pressure minimum limit (line 1)	-0,5 barg	(**)
	Calibration	Suction pressure probe adjustment (line 1)	0,0 barg	(**)
...	---	...	
Cab01	Regulation by	Compressor control by temperature or pressure (line 1)	PRESSURE	---	PRESSURE TEMPERATURE	
	Regulation type	Compressor control type (line 1)	NEUTRAL ZONE	---	PROPORTIONAL BAND NEUTRAL ZONE	
Cab02	Minimum	Compressor setpoint lower limit (line 1)	(**)	
Cab03	Maximum	Compressor setpoint higher limit (line 1)	(**)	
Cab03	Setpoint	Compressor setpoint (line 1)	(**)	

Mask index	Display description	Description	Default	UOM	Values
Cab04/Cab6 (**)	Reg.type	Type for proportional control (line 1)	PROPORT.	---	PROPORTIONAL PROP.+INT.
	Integral time	Integral time for proportional control (line 1)	300	s	0...999
Cab05/Cab7 (**)	Differential	Differential for proportional control (line 1)	... (**) (**)
	NZ diff.	Neutral zone control differential (line 1)	... (**) (**)
Cab08/Cab10 (**)	Activ.diff.	Neutral zone control differential for device activation (line 1)	... (**) (**)
	Deact.diff.	Neutral zone control differential for device deactivation (line 1)	... (**) (**)
	En.force off power	Enable capacity immediate decreasing to 0 (line 1)	NO	---	NO / YES
Cab09/Cab11 (**)	Setp.for force off	Threshold for capacity decreasing to 0 (line 1)	... (**) (**)
	Power load to 100% min time	Minimum time to increase capacity request to 100%, Neutral zone control (suction line 1)	15	s	0...9999
Cab12	Power load to 100% max time	Maximum time to increase capacity request to 100%, Neutral zone control (suction line 1)	90	s	0...9999
	Power unload to 0% min time	Minimum time to decrease capacity request to 0%, Neutral zone control (suction line 1)	30	s	0...9999
Cab13	Power unload to 0% max time	Maximum time to decrease capacity request to 0%, Neutral zone control (suction line 1)	180	s	0...9999
	Enable Aux cont.	Enable auxiliary control	NO	---	NO/YES
Cab20	Probe type	Probe used for auxiliary control	PRESSURE	---	PRESSURE/TEMPERATURE
	Refrig. type	Type of refrigerant in auxiliary circuit	R404A	---	R22 - R134a - R404A - R407C - R410A - R507A - R290 - R600 - R600a - R717 -R744 - R728 - R1270 - R417A - R422D -R413A - R422A - R423A - R407A - R427A - R245Fa - R407F - R32\
	Working hours Compressor 1	Compressor 1 operating hours (line 1)	---	h	0...999999
Cac01	(Check in...)	Compressor 1 remaining operating hours (line 1)	...	h	0...999999
	Compressor 2	Compressor 2 operating hours (line 1)	---	h	0...999999
...	(Check in...)	Compressor 2 remaining operating hours (line 1)	...	h	0...999999

Cac11	Working hours Compressor 11	Compressor 11 operating hours (line 1)	---	h	0...999999
	(Check in...)	Compressor 11 remaining operating hours (line 1)	...	h	0...999999
	Compressor 12	Compressor 12 operating hours (line 1)	---	h	0...999999
Cac13	(Check in...)	Compressor 12 remaining operating hours (line 1)	...	h	0...999999
	Compressor threshold working hours	Compressor maintenance threshold hours (line 1)	88000	h	0...999999
Cac14	Compressor hours reset	Reset compressor operating hours (line 1)	N	---	NO / YES
Cad01	Enable suction setpoint compensation	Enable setpoint compensation (suction line 1)	NO	---	NO / YES
	Enable compensation by analog IN	Enable setpoint compensation by probe (suction line 1)	NO	---	NO / YES
Cad02	Winter offset	Offset applied for Winter period	0.0	...	-999.9...999.9
	Closing offset	Offset applied for closing period	0.0	...	-999.9...999.9
Cad03	Enable setpoint compensation by scheduler	Enable scheduler setpoint compensation (suction line 1)	NO	---	NO / YES
Cad04	Activ.Time Bands	Day of the week	---	---	MON, TUE, ...SUN
	TB1: --:-- -> --:--	Time band 1 enabling and definition: start hour and minute, end hour and minute (suction line 1)	---

	TB4: --:-- -> --:--	Time band 4 enabling and definition: start hour and minute, end hour and minute (suction line 1)	---
Cad04	Changes	Time band change action	---	---	---
	Copy to	Copy settings to other days	0	---	CONFIRM&SAVE LOAD PREVIOUS CLEAR ALL MONDAY... SUNDAY; MON-FRI; MON-SAT; SAT&SUN; ALL DAYS
Cad05	Change set by DI	Enable setpoint compensation by digital input (suct/cond line 1)	NO	---	NO / YES
	---	Position of the probe for suction pressure setpoint compensation (line1)	---	---	---, B1...B10 (****)
Cad06	---	Type of the probe for suction pressure setpoint compensation (line1)	4-20mA	---	---
	---	Compensation value (line 1)	---	...	0-1V - 0-10V- 4-20mA- 0-5V
	---	Maximum value of compensation (line 1)	---	...	-99.9...99.9
	---	Minimum value of compensation (line 1)	---	...	-99.9...99.9
Cad08	Enable floating suction setpoint	Enable floating setpoint (suction line 1)	NO	---	NO / YES
Cad09	Maximum floating setpoint	Max compressor floating setpoint settable (line 1)	... (**) (**)
	Minimum floating setpoint	Minimum compressor floating setpoint settable (line 1)	... (**) (**)
Cad10	Max.setpoint variation admitted	Maximum delta admitted for floating setpoint (suction line 1)	... (**) (**)
	Offline decreasing time	Reduction time when supervisor is offline for floating setpoint (suction line 1)	0	min	0...999
Cad11	Enable interactions with pLoads	Enable interactions with pLoads (line 1)	NO	---	NO / YES
	Pressure threshold disabled	Suction pressure threshold for disabling pLoads (line 1)	...(**)	...	0.0 to 99.9
	Reactivate delay	pLoads activation delay, previously disabled by a threshold	60	s	60...9999

Mask index	Display description	Description	Default	UOM	Values
Cad12	Config. action 1	Configuration of action associated with the first digital input connected to pLoads (line 1)	NO ACTION	---	NO ACTIONLIMIT TO CURRENT CAPACITYLIMIT CAPACITY TODEC. CAPACITY BY
	---	Percentage value to limit capacity to or reduce capacity by if the "LIMIT CAPACITY TO" or "LIMIT CAPACITY BY" actions have been configured respectively (line 1)	0.0	%	0.0 to 100.0
	Config. action 2	Configuration of action associated with the second digital input connected to pLoads (line 1)	NO ACTION	---	NO ACTIONLIMIT TO CURRENT CAPACITYLIMIT CAPACITY TODEC. CAPACITY BY
	---	Percentage value to limit capacity to or reduce capacity by if the "LIMIT CAPACITY TO" or "LIMIT CAPACITY BY" actions have been configured respectively (line 1)	0.0	%	0.0 to 100.0
Cad13	Enable supervisor action	Enable pLoads action from supervisor (line 1)	NO	---	NO / YES
	Enable	Enable calculation of power consumption	NO	---	NO / YES
	Load	Number of phases	SINGLE-PHASE	---	SINGLE-PHASE/THREE-PHASE
	Voltage	Mains voltage	400	V	0 to 999
	Cos(phi)	Displacement (cosφ)	1.0	---	0.0 to 1.0
	Reset counter	Reset current power counter	NO	---	NO / YES
Cae01	Number of alarms for each compressor	Number of alarms for each compressor (line 1)	1/4 (*)	---	0...4/7 (*)
Cae02	Alarm1 description	Selection of the first compressor alarm description: Generic, Overload, High pressure, Low pressure, Oil (line 1)	...	---	<input checked="" type="checkbox"/> (Not available) <input type="checkbox"/> (Not selected) <input checked="" type="checkbox"/> (Selected)
Cae03	Alarm1 description (*)	Selection of the first compressor alarm description: Rotation, Oil warning (line 1)	...	---	<input checked="" type="checkbox"/> (Not available) <input type="checkbox"/> (Not selected) <input checked="" type="checkbox"/> (Selected)
Cae04	Activ.delay	Activation delay for compressor alarm 1 during working (line 1)	0	s	0...999
	Start up delay	Activation delay for compressor alarm 1 at start up (line 1)	0	s	0...999
	Reset	Type of reset for compressor alarm 1 (line 1)	AUT.	---	AUT. / MAN.
	Priority	Type of priority for compressor alarm 1 (line 1)	SERIOUS	---	LIGHT / SERIOUS
...	---	---	---
Cae24	Suction pressure/temperature high alarm	Type of high suction pressure/temperature alarm threshold	ABSOLUTE	---	ABSOLUTE / RELATIVE
	Threshold	High suction pressure/temperature alarm threshold	... (**) (**)
Cae25	Alarm diff.	High suction pressure/temperature alarm differential	... (**) (**)
	Alarm delay	High suction pressure/temperature alarm delay	120	s	0...999
Cae26	Suction pressure/temperature low alarm	Type of low suction pressure/temperature alarm threshold	ABSOLUTE	---	ABSOLUTE / RELATIVE
	Threshold	Low suction pressure/temperature alarm threshold	... (**) (**)
Cae27	Alarm diff.	Low suction pressure/temperature alarm differential	... (**) (**)
	Alarm delay	Low suction pressure/temperature alarm delay	30	s	0...999
Cae28	Enable oil temperature alarm management (*)	Enable Digital Scroll™ oil temperature alarm (line 1)	NO	---	NO / YES
	Enable discharge temp. alarm management (*)	Enable Digital Scroll™ discharge temperature alarm (line 1)	NO	---	NO / YES
Cae29	Low superheat alarm threshold	Threshold for low superheat alarm (line 1)	3,0	K	0.0...99.9
	Alarm diff.	Low superheat alarm differential (line 1)	1,0	K	0.0...9.9
	Switch OFF comp.	Enable compressor off for low superheat alarm (line 1)	NO	---	NO / YES
	Reset	Type of low superheat alarm reset (line 1)	MANUAL	---	MANUAL / AUTO
Cae30	Alarm delay	Low superheat alarm delay (line 1)	30	s	0...999
	Time of semi-automatic alarm evaluation	Time of semi-automatic alarm evaluation for screw compressors out of envelope (line 1)	2	min	0...999
	N° of retries before alarm becomes manual	Number of retries before alarm becomes manual (line 1)	3	---	0...9
	Switch off comp.1	Enable compressor 1 off for compressor inverter warning (line 1)	NO	---	NO / YES
Cae40	Reset	Type of compressor inverter warning reset (line 1)	MANUAL	---	MANUAL/AUTO
	Alarm delay	Compressor inverter warning activation delay (line 1)	0	s	0...999
Caf02	Compressors type	Type of compressors (line 1)	RECIPROCATING	---	RECIPROCATING SCROLL SCREW
	Compressors number	Number of compressors (line 1)	2/3 (*)	---	1...6/12 (*)
Caf03	Cmp1,...	Enable compressors (line 1)	DIS	---	DIS / EN
Caf04	Refrigerant type	Type of refrigerant (suction Line 1)	R404A	---	R22 - R134a - R404A - R407C - R410A - R507A - R290 - R600 - R600a - R717 -R744 - R728 - R1270 - R417A - R422D -R413A - R422A - R423A - R407A - R427A - R245Fa - R407F - R32
	Min on time	Minimum compressor on time (line 1)	30	s	0...999
	Min off time	Minimum compressor off time (line 1)	120	s	0...999
	Min time to start same compressor	Minimum time between same compressor starts (line 1)	360	s	0...999
Caf06	Ignition type	Type of compressors start up	DIRECT	---	DIRECT PART WINDING STAR DELTA
Caf07	Star time	Star relay run time	0	ms	0...9999
	Star line delay	Delay between star and line relay	0	ms	0...9999
	Star delta delay	Delay between star and delta relay	0	ms	0...9999
Caf08	Partwinding delay	Partwinding delay	0	ms	0...9999
Caf09	Equalization	Enable compressors equalization at start up	NO	---	NO / YES
	Equalizat.time	Equalization duration	0	s	0...999

Mask index	Display description	Description	Default	UOM	Values
Caf10	Devices rotation type	Type of rotation	FIFO	---	----- FIFO LIFO TIME CUSTOM
Caf11	Dev. unload sequence	Unloader sequence in relation to compressor activation (C=compressor, p=unloader)	CpppCp	---	----- CCppppp CpCpCp
Caf12	Load up time	Delay between different compressor starts	10	s	0...999
	Load down time	Delay between different compressor stops	0	s	0...999
	Unloader delay	Delay between stages	0	s	0...999
Caf13	Custom rotation Switch ON order	Order of switch ON for compressor custom rotation	1	---	1...16
Caf14	Custom rotation Switch OFF order	Order of switch OFF for compressor custom rotation	1	---	1...16
Caf15	Modulate speed device	Compressor driver type (line 1)	NONE	---	NONE INVERTER DIGITAL SCROLL CONTINUOUS SCREW
Caf16	Min. frequency	Minimum inverter frequency	30	Hz	0...150
	Max. frequency	Maximum inverter frequency	60	Hz	0...150
Caf17	Min on time	Compressor controlled by inverter minimum ON time (line 1)	30	s	0...999
	Min off time	Compressor controlled by inverter minimum OFF time (line 1)	60	s	0...999
	Min time to start same compressor	Compressor controlled by inverter minimum time between same compressor starts (line 1)	180	s	0...999
Caf18	Digital Scroll™ comp. valve regulation	Digital Scroll™ comp. valve control type (line 1)	OPTIMISED CONTROL	---	OPTIMISED CONTROL VARIABLE CYCLE TIME FIXED CYCLE TIME
	Cycle time	Cycle time value (line 1)	13	s	12...20
Caf19	Oil dilution	Digital Scroll™, enable oil temperature alarm (line 1)	ENABLE	---	DISABLE/ENABLE
	Disch.temper.	Digital Scroll™, enable discharge temperature alarm (line 1)	ENABLE	---	DISABLE/ENABLE
Caf20	Compr.Manufacturer	Compressor manufacturer for screw compressors	GENERIC	---	GENERIC / BITZER REFCOMP / HANBELL
	Compressor series	Compressor series	...(***)	---	...(***)
Caf21	Number of valves	Number of valves used for capacity control	3	---	1...4
	Stages configuration	Stage configuration for screw compressor 1	25/50/75 /100	%	100; 50/100; 50/75/100; 25/50/75/100; 33/66/100
Caf22	Common time	Enable common delay time (from one stage to the following) for screw compressor 1	ENABLE	---	DISABLE/ENABLE
	Common time/time between steps	Common delay time (from one stage and the following) for screw compressor 1	0	s	0...999
	From...to...	Minimum compressor delay time in order to reach each capacity stage from previous for screw compressor 1	...	s	0...999
Caf23	Intermittent valve time	Intermittent on/off time for capacity control valves for screw compressor 1	10	s	0...99
Caf24	Valve conf.	Configuration of the behaviour of the valves during start/stop and stages for screw compressor 1	...	---	O (ON) X (OFF) I (Intermittent) P (Pulsing)
Caf25	Limit comp.permanence at min power	Enable time limit at minimum capacity for screw compressor 1	ENABLE	---	DISABLE ENABLE
	Max.perman.time	Max time for compressor operation at minimum capacity for screw compressor 1	60	s	0...9999
	Limitat.on for	Time to return to minimum after the compressor was forced to second stage after staying at minimum for max. time for screw compressor 1	0	s	0...9999
Caf26	Min.output power	Minimum compressor capacity in case of high capacity range (usually 25%), only for continuous compressors	25	%	0...100
Caf27	Compressor start-up phase duration	Start-up phase time (after electric start-up)	10	s	0...999
	Maximum time to reach -maximum power	Maximum time in order to reach maximum compressor capacity (continuous capacity control)	120	s	0...999
	-minimum power	Minimum time in order to reach minimum compressor capacity (continuous capacity control)	120	s	0...999
Caf28	Intermittent	Intermittent on/off time for capacity control valves	10	s	0...99
	Pulse period	Pulsing period for valves (for continuous compressors)	3	s	1...10
	Min.Puls.Incr.	Minimum pulse time for increase capacity (valves control)	0,5	s	0,0...9,9
	Max.Puls.Incr.	Maximum pulse time for increase capacity (valves control)	1,0	s	0,0...9,9
	Min.Puls.Decr.	Minimum pulse time for decrease capacity (valves control)	0,5	s	0,0...9,9
Caf29	Max.Puls.Decr.	Maximum pulse time for decrease capacity (valves control)	1,0	s	0,0...9,9
	Valve conf.	Configuration of the behaviour of the valves during start/stop, incr.min% to 100%, decr.100% to min%, standby, decr.100% to 50%	...	---	O (ON) X (OFF) I (Intermittent) P (Pulsing)
Caf36	Number of valves	Number of control capacity valves for screw compressor 2	3	---	1...4
	Stages configuration	Stage configuration for screw compressor 2	25/50/75/100	%	100; 50/100; 50/75/100; 25/50/75/100; 33/66/100
...	---	...
Caf90	Different sizes	Enable compressors of different sizes (line 1)	NO	---	NO / YES
	Different number of valves	Enable compressor capacity control (line 1)	NO	---	NO / YES
Caf91	S1	Enable size and size for compressor group 1 (line 1)	YES 10.0	---	NO / YES 0.0...500.0
	---	...
	S4	Enable size and size for compressor group 4 (line 1)	NO	---	NO / YES 0.0...500.0

Mask index	Display description	Description	Default	UOM	Values
Caf92	S1	Enable stages and stages for compressor group 1 (line 1)	YES 100	--- %	NO/YES 100; 50/100; 50/75/100; 25/50/75/100; 33/66/100

Caf93	S4	Enable stages and stages for compressor group 4 (line 1))	NO	---	NO / YES
	---	S1...S4
Caf95	C01	Size group for compressor 1 (line 1) or presence of inverter	S1	---	S1...S4/INV
	---	...
Caf95	C12	Size group for compressor 6 (line 1)	S1	---	S1...S4
	Min on time	Minimum Digital Scroll™ compressor On time (line 1)	60	s	0...999
	Min off time	Minimum Digital Scroll™ compressor Off time(line 1)	180	s	0...999
	Min time to start same compressor	Minimum time between starts for Digital Scroll™ compressor (line 1)	360	s	0...999
	Reactivate start-up procedure after	Digital Scroll™ compressor start-up procedure reactivation time (line 1)	480	min	0...9999
Cag01	Minimum voltage	Voltage corresponding to the minimum capacity of the inverter (line 1)	0.0	V	0.0... 10.0
	Maximum voltage	Voltage corresponding to the maximum capacity of the inverter (line 1)	10.0	V	0.0... 10.0
	Nominal freq.	Nominal frequency (nominal capacity at nominal frequency) (line 1)	50	Hz	0...150
	Nominal power	Nominal capacity for compressor managed by inverter at nominal frequency (line 1)	10.0	kW	0.0... 500.0
Cag02	Rising time	Time to pass from min capacity to max capacity for modulat. device (line 1)	90	s	0...600
	Falling time	Time to pass from max capacity to min capacity for modul. device (line 1)	30	s	0...600
Cag03	Enable compressor modulation inside neutral zone	Enable compressor 1 modulation inside Neutral zone (line 1)	YES	---	NO / YES
Cag04	Enable suction press. backup probe	Enable screens for suction pressure backup probe configuration (line 1)	NO	---	NO / YES
Cag05	Request in case of regulat. probe fault	Compressor forcing value in case of suction probes fault (line 1)	50.0	%	0.0... 100.0
Cag06	Enable anti liquid return valve	Enable liquid non return function (line 1)	NO	---	NO / YES
Cag07	Enable compressor envelope management (*)	Enable compressor envelope management (screw only). <i>For details on configuration contact Carel.</i>	NO	---	NO / YES

The following parameters refer to line 2, for details see the corresponding parameters for line 1 above

Cba01	DI	Alarm 1 for compressor 1 DI position (line 2)	03	---	---,01...18,B1...B10 (****)
	Status (display only)	Status of alarm 1 for compressor 1 DI (line 2)	---	---	Closed / Open
	Logic	Logic of alarm 1 for compressor 1 DI (line 2)	NC	---	NC / NO
	Function (display only)	Alarm 1 for compressor 1 function status (line 2)	---	---	Not active / Active
...
Cbb01	Regulation by	Compressor control by temperature or pressure (line 2)	PRESSURE	---	PRESSURE / TEMPERATURE
	Regulation type	Compressor control type (line 2)	NEUTRAL ZONE	---	PROPORTIONAL BAND NEUTRAL ZONE
...	---	---	...
Cbc01	Working hours Compressor 1	Compressor 1 max operating hours (line 2)	---	---	0...999999
...	---	---	...
Cbd01	Enable suction setpoint compensation	Enable setpoint compensation (suction line 2)	NO	---	NO / YES
	Enable compensation by analog IN	Enable setpoint compensation by probe (suction line 2)	NO	---	NO / YES
...	---	---	...
Cbe01	Number of alarms for each compressor	Number of alarms for each compressor (line 2)	1	---	0 to 4
...	---	---	...
Cbf02	Compressors type	Type of compressors (line 2)	RECIPROCATING	---	RECIPROCATING SCROLL
	Compressors number	Number of compressors (line 2)	2/3 (*)	---	1...12
...	---	---	...
Cbg01	Minimum voltage	Voltage corresponding at the minimum capacity of the inverter (line 2)	0.0	Hz	0.0... 10.0
	Maximum voltage	Voltage corresponding at the maximum capacity of the inverter (line 2)	10.0	Hz	0.0... 10.0
	Nominal freq.	Nominal frequency (nominal capacity at nominal frequency) (line 2)	50	Hz	0...150
	Nominal power	Nominal capacity for compressor managed by inverter at nominal frequency (line 2)	10.0	kW	0.0... 500.0
...	---	---	...

Mask index	Display description	Description	Default	UOM	Values
------------	---------------------	-------------	---------	-----	--------

 **D. Condensers** (The I/Os available depend on the selected configuration, the following are just some examples. For the complete list of I/O positions available see Appendix A.5)

Daa01	DI	Fan 1 overload DI position (line 1)	...	---	---,01...18,B1...B10 (****)
	Status (display only)	Status of fan 1 overload DI (line 1)	---	---	Closed / Open
	Logic	Logic of fan 1 overload DI (line 1)	NC	---	NC / NO
	Function (display only)	Fan 1 overload function status (line 1)	---	---	Not active / Active
...	---	---	...
Daa39	---	Condenser probe position (line 1)	B1	---	---, B1...B10 (****)
	---	Condenser probe type (line 1)	4-20mA	---	0-1V 0-10V 4-20mA 0-5V
	--- (display only)	Condensing pressure value (line 1)	---(**)
	Max limit	Maximum condensing pressure value (line 1)	30.0 barg(**)
	Min limit	Minimum condensing pressure value (line 1)	0,0 barg(**)
	Calib.	Condensing pressure probe calibration (line 1)	0,0 barg(**)
...	---	---	...

Mask index	Display description	Description	Default	UOM	Values
Daa21	DO	Fan 1 DO position (line 1)	03	---	---,01...29 (****)
	Status (display only)	Status of fan 1 DO (line 1)	---	---	Closed / Open
	Logic	Logic of fan 1 DO (line 1)	NC	---	NC / NO
	Function (display only)	Fan 1 function status (line 1)	---	---	Not active / Active
...
Daa38	AO	Inverter fan AO position (line 1)	0	---	---,01...06 (****)
	Type (****)	Type of output, PWM / phase control per AO fan inverters (line 1)	FC31*-CON-VONOFF	---	FC31*-CONVONOFF; "-----"; MCHRTF*"; FCS3*-CONV010"
	Status (display only)	Inverter fan output value (line 1)	0	%	0.0...100.0
...
Dab01	Regulation by	Condenser control by temperature or pressure (line 1)	PRESSURE	---	PRESSURE/TEMPERATURE
	Regulation type	Condenser control type (line 1)	PROPORTI. BAND	---	PROPORTIONAL BAND NEUTRAL ZONE
Dab02	Minimum	Condenser setpoint lower limit (line 1)	... (**) (**)
Dab02	Maximum	Condensers setpoint higher limit (line 1)	... (**) (**)
Dab03	Setpoint	Condenser setpoint (line 1)	... (**) (**)
Dab04	Fans work only when at least one compressor works	Enable fan operation linked to compressor operation	NO	---	NO / YES
	Cut_Off enable	Enable fan cut-off function	NO	---	NO / YES
Dab05	Cut-Off request	Cut-off value	0.0	%	0.0...100.0
	Diff.	Cut-off differential	... (**) (**)
	Hysteresis	Cut-off hysteresis	... (**) (**)
Dab6/ Dab8 (**)	Reg.type	Type for proportional control (condenser line 1)	PROP.	---	PROP. PROP.+INT.
	Integral time	Integral time for prop. control (cond. line 1)	300	s	0...999
Dab7/ Dab9 (**)	Differential	Differential for proportional control (cond. line 1)	... (**) (**)
Dab10/Dab11 (**)	NZ diff.	Neutral zone control differential (line 1)	... (**) (**)
	Activ.diff.	Neutral zone control differential for device activation (line 1)	... (**) (**)
	Deact.diff.	Neutral zone control differential for device deactivation (line 1)	... (**) (**)
Dab12/Dab13 (**)	En.force off power	Enable capacity immediate decreasing to 0 (line 1)	NO	---	NO / YES
	Setp.for force off	Threshold for capacity decreasing to 0 (line 1)	... (**) (**)
Dab14	Power load to 100% min time	Minimum time to increase capacity request to 100%, Neutral zone control (condenser line 1)	15	s	0...9999
	Power load to 100% max time	Maximum time to increase capacity request to 100%, Neutral zone control (condenser line 1)	90	s	0...9999
Dab15	Power unload to 0% min time	Minimum time to decrease capacity request to 0%, Neutral zone control (condenser line 1)	30	s	0...9999
	Power unload to 0% max time	Maximum time to decrease capacity request to 0%, Neutral zone control (condenser line 1)	180	s	0...9999
Dad01	Enable condensing setpoint compensation	Enable setpoint compensation (condenser line 1)	NO	---	NO / YES
Dad02	Winter offset	Enable setpoint compensation (condenser line 1)	0.0	...	-999.9...999.9
	Closing offset	Offset applied for Winter period	0.0	...	-999.9...999.9
Dad03	Enable setpoint compensation by scheduler	Enable scheduler setpoint compensation (condenser line 1)	NO	---	NO / YES
Dad04	Activ.Time Bands	Day of the week	---	---	MON, ...SUN
	TB1: --:-- -> --:--	Time band 1 enabling and definition: start hour and minute, end hour and minute (suction line 1)	---

	TB4: --:-- -> --:--	Time band 4 enabling and definition: start hour and minute, end hour and minute (suction line 1)	---
	Changes	Time band changes action	---	---	---
Copy to	Copy settings to other days	0	---	MONDAY...SUNDAY; MON-FRI; MON-SAT; SAT&SUN; ALL DAYS	
Dad05	Enable floating condensing setpoint	Enable floating setpoint (condenser line 1)	NO	---	NO / YES
Dad06	Offset for external temperature	Temperature delta for floating setpoint (condenser line 1)	0.0	...	-9.9...9.9
	Controlled by: -Digital input	Enable floating condensing from digital input	NO	---	NO / YES
Dad07	Change set by digital input	Enable setpoint compensation by digital input (suction/condensing line 1)	NO	---	NO / YES
Dae01	Cond.pressure/temperature high alarm	Type of high condensing pressure/temperature alarm threshold (line 1)	ABSOLUTE	---	ABSOLUTE / RELATIVE
	Threshold	High condensing pressure/temperature alarm threshold (line 1)	24.0 barg (**)
Dae02	Cond.pressure/temperature alarm diff.	High condensing pressure/temperature alarm differential (line 1)	1.0 barg (**)
	Alarm delay	High condensing pressure/temperature alarm delay (line 1)	60	s	0...999
Dae03	Cond.pressure/temperature low alarm	Type of low condensing pressure/temperature alarm threshold (line 1)	ABSOLUTE	---	ABSOLUTE / RELATIVE
	Threshold	Low condensing pressure/temperature alarm threshold (line 1)	7.0 barg (**)
Dae04	Cond.pressure/temperature alarm diff.	Low condensing pressure/temperature alarm differential (line 1)	1.0 barg (**)
	Alarm delay	Low condensing pressure/temperature alarm delay (line 1)	30	s	0...999
Dae05	Common fan overload	Common fan overload (line 1)	YES	---	NO / YES
	Delay	Common fan overload alarm activation delay	AUTOMATIC	---	AUTOMATIC / MANUAL
	Reset	Type of common fan overload alarm reset	0	s	0 to 500
Daf01	Number of present fans	Number of fans (line 1)	3	---	0 to 16
Daf02	Fan1, Fan2, ...	Enable fans 1 to 12 (line 1)	EN	---	DIS / EN
Daf03	Fan13, Fan14, ...	Enable fans 13 to 16 (line 1)	EN	---	DIS / EN

Mask index	Display description	Description	Default	UOM	Values
Daf04	Refrigerant type	Type of refrigerant (condenser line 1)	R404A	---	R22 - R134a - R404A - R407C - R410A - R507A - R290 - R600 - R600a - R717 - R744 - R728 - R1270 - R417A - R422D - R413A - R422A - R423A - R407A - R427A - R245Fa - R407F - R32
Daf05	Devices rotation type	Type of rotation devices (condenser line 1)	FIFO	---	----- FIFO LIFO TIME CUSTOM
Daf07, Daf08	Custom rotation Switch ON order	Switch ON order for fans with custom rotation (condenser line 1)	1	---	1...16
Daf09, Daf10	Custom rotation Switch OFF order	Switch OFF order for fans with custom rotation (condenser line 1)	1	---	1...16
Dag01	Modulate speed device	Fan driver type (line 1)	NONE	---	NONE INVETER PHASE CONTROL
	Type (****)	Type of output, PWM / phase control for condenser modulating device (line 1)	----	---	---- MCHRTF* FCS3*-CONV010
Dag02	Neutral zone req.	Fan control also inside Neutral zone (line 1)	NO	---	NO / YES
	Min.out value	Minimum voltage for compressor inverter (line 1)	0.0	V	0.0 to 9.9
	Max.out value	Maximum voltage for compressor inverter (line 1)	10.0	V	0.0 to 99.9
	Min. power refer.	Minimum capacity of fan modulating device (line 1)	60	%	0...100
Dag03	Max. power refer.	Maximum capacity of fan modulating device (line 1)	100	%	0...99.9
	Rising time	Time to pass from min capacity to max capacity for fan modulating device (line 1)	1200	s	0 to 32000
	Falling time	Time to pass from max capacity to min capacity for fan modulating device (line 1)	1200	s	0 to 32000
Dag04	Num.control.fans	Number of fans under inverter (only for alarm enabling)	1	---	0 to 16
	Split Condenser	Enable split condenser (line 1)	NO	---	NO / YES
	Controlled by: -Digital input	Split Condenser controlled by digital input (line 1)	---	---	NO / YES
	-External temp.	Split Condenser controlled by outside temperature (line 1)	---	---	NO / YES
Dag05	-Scheduler	Split Condenser controlled by scheduler (line 1)	---	---	NO / YES
	Est. Temp.Thr.	Split condenser by outside temperature management setpoint (line 1)	10.0 °C	...	-99.9...99.9
Dag06	Est. Temp.Diff.	Split condenser by outside temperature management differential (line 1)	2.5 °C	...	-99.9...99.9
	Type	Fans enabled with split condenser (line 1)	CUSTOM	---	CUSTOM ODD EVEN GREATER THAN LESS THAN
	---	Only when enabling type is GREATER THAN or LESS THAN, number of fans to consider for splitting (line 1)	0	---	0 to 16
Dag09	Disable split condenser as first stage of HP pressostat for	Disable split condenser when high condensing pressure prevent occurs (line 1)	NO	---	NO / YES
		Duration of split condenser deactivation for high condensing pressure prevent (line 1)	0	h	0 to 24
Dag10	Anti-noise	Enable silencer (line 1)	DISAB.	---	DISABLE / ENABLE
	Max output	Maximum request allowed when silencer function is active (line 1)	75.0 %	%	0.0...100.0
	Controlled by: -Digital input	Silencer controlled by digital input (condenser line 1)	NO	---	NO / YES
	-Scheduler	Silencer controlled by scheduler (condenser line 1)	NO	---	NO / YES
Dag12	Activ.Time Bands	Day of the week	---	---	MON, ..., SUN
	TB1: --- --> ---	Time band 1 enabling and definition: start hour and minute, end hour and minute (condenser line 1)	---
	---
	TB4: --- --> ---	Time band 4 enabling and definition: start hour and minute, end hour and minute (condenser line 1)	---
	Changes	Time band changes action	---	---	---
	Copy to	Copy settings to other days	0	---	MONDAY...SUNDAY; MON-FRI; MON-SAT; SAT&SUN; ALL DAYS
Dag13	Speed Up	Enable speed up (condenser line 1)	YES	---	NO / YES
	Speed Up time	Speed up time (condenser line 1)	5	s	0...60
	Ext.Temp.Manage	Enable speed up management by outside temperature (condenser line 1)	DIS	---	DIS / EN
	Ext.Temp.Thresh.	Outside temperature threshold for speed up management (condenser line 1)	25.0 °C	...	-99.9...99.9
	Ext.Temp.Diff.	Outside temperature differential for speed up management (condenser line 1)	2.5 °C	...	-99.9...99.9
Dag14	Enable condensing press. backup probe	Enable the screens for condensing pressure backup probe configuration (condenser line 1)	NO	---	NO / YES
Dag15	Request in case of egulat. probes fault	Value of fans forcing in case of condensing probes fault (line 1)	50.0	%	0.0...100.0

The following parameters refer to line 2, for details see the corresponding parameters for line 1 above

Dba01	DI	Fan 1 overload DI position (line 2)	...	---	---, 01...18, B1...B10 (****)
	Status (display only)	Status of fan 1 overload DI (line 2)	---	---	Closed / Open
	Logic	Logic of fan 1 overload DI (line 2)	NC	---	NC / NO
	Function (display only)	Fan 1 overload function status (line 2)	---	---	Not active Active
---	---	---	---	---	---

Mask index	Display description	Description	Default	UOM	Values
Dbb01	Regulation by	Condenser control by temperature or pressure (line 2)	PRESSURE	---	PRESSURE TEMPERATURE
	Regulation type	Condenser control type (line 2)	NEUTRAL ZONE	---	PROPORTIONAL BAND NEUTRAL ZONE
...
Dbd01	Enable condensing setpoint compensation	Enable setpoint compensation (condenser line 2)	NO	---	NO YES

Dbe01	Cond.temperature/pressure high alarm	Type of high condensing pressure/temperature alarm threshold (line 2)	ABSOLUTE	---	ABSOLUTE RELATIVE
	Threshold	High condensing pressure/temperature alarm threshold (line 2)	24,0 barg (**)
...
Dbf01	Number of present fans	Number of fans (line 2)	3	---	0 to 16

Dbg01	Modulate speed device	Fan driver type (line 2)	NONE	---	NONE INVETER PHASE CONTROL
	Type (****)	Type of output, PWM / phase control for condenser modulating device (line 2)	---	---	MCHRTF* FCS3*-CONV010
...

Mask index	Display description	Description	Default	UOM	Values
------------	---------------------	-------------	---------	-----	--------

 E. Other functions. (The I/Os available depend on the selected configuration, the following are just some examples. For the complete list of I/O positions available see Appendix A.5)

Eaaa04	---	Oil temperature probe position (line 1)	B1	---	---, B1...B10 (****)
	---	Oil temperature probe type (line 1)	4-20mA	---	---
	---	Oil temperature probe value (line 1)	--- (**)
	Upper value	Oil temperature probe max. limit (line 1)	30.0 barg (**)
	Lower value	Oil temperature probe min. limit (line 1)	0.0 barg (**)
...
Eaaa45	DO	Oil level valve DO position, compressor 6 (line 1)	03	---	---, 01...29 (****)
	Status (display only)	Oil level valve DO status, compressor 6 (line 1)	---	---	Closed / Open
	Logic	Oil level valve DO logic, compressor 6 (line 1)	NC	---	NC / NO
	Function (display only)	Oil level function status, compressor 6 (line 1)	---	---	Not active / Active
Eaab04	Common oil cooler	Enable common oil cooling (line 1)	YES	---	NO / YES
	Oil pumps number	Number of oil pumps for common oil cooler (line 1)	0	---	0 to 1 (Analog output) 0 to 2 (Digital outputs)
	Enable Aout pump	Enable AO of common oil cooler pump (line 1)	YES	---	NO (Digital outputs) YES (Analog output)
Eaab05	Setpoint	Common oil cooler setpoint (line 1)	0.0 °C (**)
	Differential	Common oil cooler differential (line 1)	0.0 °C	...	-9.9...9.9
Eaab06	Pump start delay	Time delay before the start-up of pump 2 after pump1 turns on (line 1)	0	s	0...999
Eaab07	Oil pumps number	Screw compressors: number of oil cooler pumps enabled (line 1)	0	---	0 to 1 (Analog output) 0 to 2 (Digital outputs)
	Enable Aout pump	Screw compressors: enable AO for oil cooler pump (line 1)	YES	---	NO (Digital outputs) YES (Analog output)
Eaab08	Setpoint	Screw compressors: oil temperature setpoint (line 1)	0.0	°C/°F	...
	Differential	Screw compressors: oil temperature differential (line 1)	0.0	°C/°F	...
Eaab09	Threshold	Common oil high temperature alarm threshold (line 1)	100.0 °C	°C/°F	...
	Differential	Common oil high temperature alarm differential (line 1)	10.0 °C	°C/°F	...
	Delay	Common oil high temperature alarm delay (line 1)	0	s	0 to 32767
Eaab10	En.oil lev.manag.	Enable oil level management (line 1)	NO	---	NO / YES
	Num.Alarm oil level	Number of compressor alarm associated with oil level (line 1)	0	---	0 to 4/7 (*)
Eaab11	Time open	Oil level valve opening time (line 1)	0	s	0...999
	Time close	Oil level valve closing time (line 1)	0	s	0...999
Ebaa01	DO	Subcooling valve DO position (line 1)	...	---	---, 01...29 (****)
	Status (display only)	Status of subcooling valve DO (line 1)	---	---	Closed / Open
	Logic	Logic of subcooling valve (line 1)	NO	---	NC / NO
	Function (display only)	Subcooling valve function status (line 1)	---	---	Not active / Active
Ebab01	Subcooling control	Enable subcooling function (line 1)	NO	---	NO / YES
	---	Subcooling control type (line 1)	BY COND. & LIQUID TEMP.	---	BY COND.& LIQUID TEMP. ONLY BY LIQUID TEMP.
	Threshold	Threshold for subcooling control (line 1)	0.0 °C	...	-9999.9...9999.9
Ecaa01	Subcool.value (display only)	Subcooling value (line 1)	0.0 °C	...	-999.9...999.9
	---	Discharge temperature probe position, compressor 1 (line 1)	B1	---	---, B1...B10 (****)
	---	Type of discharge temperature probe, compressor 1 (line 1)	4-20mA	---	---
	---	Discharge temperature value, compressor 1 (line 1)	--- (**)
	Upper value	Maximum discharge temperature value, compressor 1 (line 1)	30.0 barg (**)
...
Ecaa12	Lower value	Minimum discharge temperature value, compressor 1 (line 1)	0.0 barg (**)
	Calibration	Discharge temperature probe calibration, compressor 1 (line 1)	0.0 barg (**)

	DO	Economizer valve DO position, compressor 6 (line 1)	...	---	---, 01...29 (****)
Ecab04 (*)	Status (display only)	Economizer valve DO status, compressor 6 (line 1)	---	---	Closed / Open
	Logic	Economizer valve DO logic, compressor 6 (line 1)	NO	---	NC / NO
	Function (display only)	Economizer valve function status, compressor 6 (line 1)	---	---	Not active / Active
Ecab04 (*)	Economizer	Enable economizer function (line 1)	NO	---	NO / YES
	Compr.Power Thr.	Capacity percentage threshold for economizer activation (line 1)	0	%	0...100
	Press.Lim.	Condensing temperature threshold for economizer activation (line 1)	0.0 °C	...	-999.9...999.9
Disch.T.Thr.	Discharge temperature threshold for economizer activation (line 1)	0.0 °C	...	-999.9...999.9	

Mask index	Display description	Description	Default	UOM	Values
Ecab05 (*)	Economizer	Enable economizer function for screw compressor 1 (line 1)	NO	---	NO / YES
	Setpoint	Setpoint for economizer function with discharge temperature for screw compressor 1	... (**) (**)
	Differential	Differential for economizer function with discharge temperature for screw compressor 1	... (**) (**)
Ecab06 (*)	Min.power activ.	Minimum screw compressor 1 capacity for economizer activation	75	%	0; 25; 50; 75; 100
	Cond.press.check	Enable economizer function with condensing temperature for screw compressor 1	DIS	---	DIS / EN
	Setpoint	Setpoint for economizer function with condensing temperature for screw compressor 1	60.0	°C/°F	...
	Differential	Differential for economizer function with condensing temperature for screw compressor 1	5.0	°C/°F	...
Edaa01	---	Discharge temperature probe position, compressor 1 (line 1)	B1	---	---, B1...B10 (****)
	---	Compressor 1 discharge temperature probe position (line 1)	4-20mA	---	---
	---	Compressor 1 discharge temperature probe type (line 1)	--- (**)
	Upper value	Compressor 1 discharge temperature probe value (line 1)	30.0 barg (**)
	Lower value	Compressor 1 discharge temperature probe max. limit (line 1)	0.0 barg (**)
	Calibration	Compressor 1 discharge temperature probe min. limit (line 1)	0.0 barg (**)
	...	Compressor 1 discharge temperature probe adjustment (line 1)
Edaa12	DO	Injection valve DO position, compressor 6 (line 1)	...	---	---, 01...29 (****)
	Status (display only)	Injection valve DO status, compressor 6 (line 1)	---	---	Closed / Open
	Logic	Injection valve DO logic, compressor 6 (line 1)	NO	---	NC / NO
	Function (display only)	Injection valve function status, compressor 6 (line 1)	---	---	Not active / Active
Edab01/ Edab03 (*)	Liquid Injection	Enable liquid injection function (line 1)	DIS	---	DIS / EN
	Threshold	Liquid injection set point (line 1)	70.0 °C (**)
	Differential	Liquid injection differential (line 1)	5,0 (**)
Eeaa02	DI	Heat recovery from digital input DI position (line 1)	...	---	---, 01...18, B1...B10 (****)
	Status (display only)	Status of heat recovery DI (line 1)	---	---	Closed / Open
	Logic	Logic of heat recovery DI (line 1)	NC	---	NC NO
	Function (display only)	Status of heat recovery from digital input DI function (line 1)	---	---	Not active / Active
Eeaa03	DO	Heat recovery pump DO position (line 1)	---	---	---, 01...29
	Status (display only)	Heat recovery pump DO status (line 1)	---	---	Closed / Open
	Logic	Heat recovery pump DO logic (line 1)	NC	---	NC / NO
	Function (display only)	Heat recovery pump status (line 1)	---	---	Not active / Active
Eeaa04	AO	Heat recovery damper AO position (line 1)	---	---	---, 01...29
	Type (****)	Type of output, PWM / phase control for heat recovery damper AO (line 1)	FCS1*-CON-VONOFF	---	---- FCS1*-CONVONOFF MCHRTF*
Eeaa05	Status	Heat recovery damper AO status (line 1)	---	---	FCS3*-CONV010
	---	Heat recovery outlet temperature probe position (line 1)	B1	---	---, B1...B10 (****)
	---	Type of heat recovery outlet temperature probe (line 1)	4-20mA	---	---
	---	Heat recovery outlet temperature value (line 1)	--- (**)
	Upper value	Maximum heat recovery outlet temperature value (line 1)	30.0 barg (**)
	Lower value	Minimum heat recovery outlet temperature value (line 1)	0.0 barg (**)
	Calibration	Heat recovery outlet temperature probe calibration (line 1)	0.0 barg (**)
Eeab01	Enable Heat Reclaim	Enable heat recovery function (line 1)	NO	---	NO / YES
Eeab02	Condensing pressure Lower Limit	Condensing pressure lower limit for heat recovery (line 1)	0.0 barg (**)
Eeab03	Modulation by temperat.	Enable heat recovery control by discharge temperature (line 1)	NO	---	NO / YES
Eeab04	Setpoint	Heat recovery: discharge temperature setpoint (line 1)	0.0 °C (**)
	Differential	Heat recovery: discharge temperature differential (line 1)	0.0 °C	...	0.0 ... 99.9
Eeab05	Disable floating condensing pressure	Disable floating condensing pressure when heat reclaim is active	NO	---	NO / YES
	Setpoint offset	Offset that must be applied to the condensing setpoint instead of floating condensing when heat reclaim is active	---	...	-99.9...99.9
Eeab06	Enable activation by scheduler	Enable heat recovery control by scheduler (line 1)	NO	---	NO / YES
Eeab07	Active.Time Bands	Week of the day	---	---	MON, ..., SUN
	TB1: --:-- --:--	Time band 1 enabling and definition: start hour and minute, end hour and minute (condenser line 1)	---

	TB4: --:-- --:--	Time band 4 enabling and definition: start hour and minute, end hour and minute (condenser line 1)	---
	Changes	Time band changes action	---	---	---
Efa05	Copy to	Copy settings to other days	0	---	CONFIRM&SAVE LOAD PREVIOUS CLEAR ALL
	Gen.Funct.1	Enable generic stage function 1	DISAB.	---	MONDAY...SUNDAY; MON-FRI; MON-SAT; SAT&SUN; ALL DAYS
Efa06	---	DISABLE / ENABLE
	Gen.Funct.5	Enable generic stage function 5	DISAB.	---	DISABLE / ENABLE
Efa07	Regulation variable Mode	Control variable for generic stage function 1 Direct or reverse control	---	---	DIRECT / REVERSE
	Enable	Enabling variable for generic stage function 1	---	---	...
Efa08	Description	Enable description change	SKIP	---	SKIP / CHANGE
	-----	Description	---	---	...
Efa08	Setpoint	Setpoint for generic stage function 1	0.0 °C (**)
	Differential	Differential for generic stage function 1	0.0 °C (**)

Mask index	Display description	Description	Default	UOM	Values	
Efa09	High alarm	High alarm enabling for generic stage function 1	DISAB.	---	DISABLE / ENABLE	
	High alarm	High alarm threshold for generic stage function 1	0.0 °C (**)	
	Delay time	High alarm delay for generic stage function 1	0	s	0...9999	
	Alarm type	Low alarm enabling for generic stage function 1	LIGHT	---	LIGHT / SERIOUS	
	Low alarm	Low alarm threshold for generic stage function 1	DISAB.	---	DISABLE / ENABLE	
	Low alarm	Low alarm delay for generic stage function 1	0.0 °C (**)	
	Delay time	Low alarm delay for generic stage function 1	0	s	0...9999	
...	Alarm type	Type of low alarm for generic stage function 1	LIGHT	---	LIGHT / SERIOUS	
...	
Efb05	Gen.Modulat.1	Enable generic modulating function 1 management	DISAB.	---	DISABLE / ENABLE	
	Gen.Modulat.2	Enable generic modulating function 2 management	DISAB.	---	DISABLE / ENABLE	
Efb06	Regulation variable	Control variable for generic modulating function 1	---	---	---	
	Mode	Direct or reverse modulation	DIRECT	---	DIRECT / REVERSE	
Efb07	Enable	Enabling variable for generic modulating function 1	---	---	---	
	Description	Enable description change	SKIP	---	SKIP / CHANGE	
...	-----	Description	---	---	---	
Efb08	Setpoint	Setpoint for generic modulating function 1	0.0 °C (**)	
	Differential	Differential for generic modulating function 1	0.0 °C (**)	
Efb09	High alarm	High alarm enabling for generic modulating function 1	DISAB.	---	DISABLE / ENABLE	
	High alarm	High alarm threshold for generic modulating function 1	0.0 °C (**)	
	Delay time	High alarm delay for generic modulating function 1	0	s	0...9999	
	Alarm type	Low alarm enabling for generic modulating function 1	LIGHT	---	LIGHT / SERIOUS	
Efb10	Out upper limit	Output upper limit for generic modulating function 1	100.0	%	0...100	
	Out lower limit	Output lower limit for generic modulating function 1	0.0	%	0...100	
	Enable cutoff	Enable cut off function for generic modulating function 1	NO	---	NO / YES	
	Cutoff diff.	Cut off differential for generic modulating function 1	0.0 °C (**)	
...	Cutoff hys.	Cut off hysteresis for generic modulating function 1	0.0 °C (**)	
Efb20	Low alarm	Low alarm enabling for generic modulating function 1	DISAB.	---	DISABLE / ENABLE	
	Low alarm	Low alarm threshold for generic modulating function 1	0.0 °C (**)	
	Delay time	Low alarm delay for generic modulating function 1	0	s	0...9999	
...	Alarm type	Low alarm type for generic modulating function 1	LIGHT	---	LIGHT / SERIOUS	
...	
Efc05	Gen.alarm 1	Enable generic alarm function 1 management	DISAB.	---	DISABLE / ENABLE	
	Gen.alarm 2	Enable generic alarm function 2 management	DISAB.	---	DISABLE / ENABLE	
Efc06	Regulation variable	Monitored variable for generic alarm function 1	---	---	---	
	Enable	Enabling variable for generic alarm function 1	---	---	---	
	Description	Enable description change	SKIP	---	SKIP / CHANGE	
...	-----	Description	---	---	---	
Efc07	Alarm type	Alarm type for generic alarm function 1	LIGHT	---	LIGHT / SERIOUS	
	Delay time	Delay for generic alarm function 1	0	s	0...9999	
...	
Efd05	Generic Function Scheduler	Enable generic scheduler function	DISAB.	---	DISABLE / ENABLE	
	Gen.func.scheduling connected to global scheduling	Generic scheduler function considers the same special days and periods of global scheduler	NO	---	NO / YES	
Efd06	Enable	Enabling variable for generic scheduler function	---	---	---	
	Activ.Time Bands	Day of the week	---	---	MON, ..., SUN	
Efd07	TB1: --:-- -> --:--	Time band 1 enabling and definition: start hour and minute, end hour and minute (suction line 1)	---	---	---	
	---	---	---	
	TB4: --:-- -> --:--	Time band 4 enabling and definition: start hour and minute, end hour and minute (suction line 1)	---	---	---	
	Changes	Time band changes action	---	---	---	
...	Copy to	Copy settings to other days	0	---	CONFIRM&SAVE LOAD PREVIOUS CLEAR ALL MONDAY...SUNDAY; MON-FRI; MON-SAT; SAT&SUN; ALL DAYS	
Efe05	Gen.A Measure	Generic analogue input A unit of measure selection	°C	---	°C; °F; barg; psig; %; ppm -	
...	
Efe06/Efe07 (**)	---	Generic probe A position	B1	---	---, B1...B10 (****)	
	---	Generic probe A type	4-20mA	---	... (**)	
	---	Generic probe A value	---	---	... (**)	
	---	Upper value	Generic probe A max. limit	30.0 barg (**)
	---	Lower value	Generic probe A min. limit	0.0 barg (**)
	---	Calibration	Generic probe A adjustment	0.0 barg (**)
...	
Efe16	DI	Generic digital input F DI position	---	---	---, 01...18, B1...B10 (****)	
	Status (display only)	Status of generic digital input F DI	---	---	Closed / Open	
	Logic	Logic of generic digital input F DI	NC	---	NC / NO	
	Function (display only)	Status of generic digital input F DI	---	---	Not active / Active	
...	
Efe21	DO	Generic stage 1 DO position	---	---	---, 01...29 (****)	
	Status (display only)	Status of generic stage 1 DO	---	---	Closed / Open	
	Logic	Logic of generic stage 1 DO	NO	---	NC / NO	
...	Function (display only)	Generic stage 1 DO function status	---	---	Not active / Active	
...	
Efe29	Modulating.1	Generic modulating 1 AO position	0	---	---, 01...06 (****)	
	Type (****)	Type of output, PWM / phase control for generic modulating function 1 AO (line 1)	FCS1*-CON-VONOFF	---	FCS1*-CONVONOFF; "-----"; MCHRTF**;" FCS3*-CONV010"	
	Status (display only)	Generic modulating 1 output value	0	%	0.0...100.0	
...	
Egaa01	DI	ChillBooster fault DI position (line 1)	---	---	---, 01...18, B1...B10 (****)	
	Status (display only)	Status of ChillBooster fault DI (line 1)	---	---	Closed / Open	
	Logic	Logic of ChillBooster fault DI (line 1)	NC	---	NC / NO	
	Function (display only)	Status of ChillBooster fault (line 1)	---	---	Not active / Active	

Mask index	Display description	Description	Default	UOM	Values
Egaa02	DO	ChillBooster DO position (line 1)	---	---	---, 01...29 (****)
	Status (display only)	Status of ChillBooster DO (line 1)	---	---	Closed / Open
	Logic	Logic of ChillBooster DO (line 1)	NO	---	NC / NO
Egab01	Function (display only)	Status of ChillBooster function (line 1)	---	---	Not active / Active
	Device present	Enable ChillBooster function (line 1)	NO	---	NO / YES
Egab02	Deactivation when fan-spower falls under	Fan capacity under which ChillBooster is deactivated (line 1)	95	%	0...100
	Before the activation fans at max for	Fans work at maximum capacity at least for this time before ChillBooster activation (line 1)	5	min	0 to 300
Egab03	Ext.Temp.Thr.	Outside temperature threshold for ChillBooster activation (line 1)	30.0 °C	---	... (**)
	Sanitary proc. start at	Enable hygiene procedure (line 1)	Disab.	---	DISABLE / ENABLE
	Duration	Hygiene procedure starting time (line 1)	00:00	---	---
Egab04	Ext.temp.thr	Hygiene procedure duration (line 1)	0	min	0 to 30
	ChillBooster requires maintenance after	Outside temperature threshold for hygiene procedure activati. (line 1)	5.0 °C	---	... (**)
Ehb01	Reset maintenance time	ChillBooster maximum running time (line 1)	200	h	0...999
	Avoid simultaneous pulses betw.lines	ChillBooster maintenance time reset (line 1)	NO	---	NO / YES
Ehb03	Delay	Enable simultaneous compressor start up inhibition	NO	---	NO / YES
	Force off L2 Comp.s for line 1 fault	Delay between start up for compressors on different lines	0	s	0...999
Ehb04	Delay	Enable line 2 compressor switch OFF due to line 1 compressor fault	NO	---	NO / YES
	Switch on L1 Comp.s for L2 activation	Delay for line 2 compressor switch off after serious alarm on line 1 compressors	0	s	0...999
	Switch on period	Enable line 1 compressor switch ON due to line 2 compressor switch ON	NO	---	NO / YES
Ehb05	Force off line 2 if line 1 is off	Delay for line1 compressor switch on for line 2 compressor switch on	30	s	0...999
	Enable min threshold for L1 activation	Enable line 2 compressor switch OFF due to line 1 switch OFF	NO	---	NO / YES
Eia02	Threshold	Enable L1 activation by DSS only when suction pressure is greater than a minimum threshold	NO	---	NO / YES
	Setpoint SH	Minimum threshold for line 1 activation by DSS	---	---	... (**)
	LowSH thres.	PID control set point (valve 1)	11.0	K	-40.0...180.0
Eia04	LOP thresh.	Low superheat protection threshold (valve 1)	5.0	K	-40.0...180.0
	MOP thresh.	Low operating pressure protection threshold (valve 1)	-50.0	---	-60.0...200.0
	Setpoint SH	Maximum operating pressure protection threshold (valve 1)	50.0	---	-60.0...200.0
Eib02	LOP thresh.	PID control set point (valve 2)	11.0	K	-40.0...180.0
	MOP thresh.	Low superheat protection threshold (valve 2)	5.0	K	-40.0...180.0
	LOP thresh.	Low operating pressure protection threshold (valve 2)	-50.0	---	-60.0...200.0
Eib04	MOP thresh.	Maximum operating pressure protection threshold (valve 2)	50.0	---	-60.0...200.0
	Enable manual Valve position	Enable manual positioning (valve 1)	NO	---	NO/YES
Eic02	Manual valve position:	Manual position (valve 1)	0	---	Min / Max
	Enable manual Valve position	Enable manual positioning (valve 2)	NO	---	NO/YES
Eic03	Manual valve position:	Manual position (valve 2)	0	---	Min / Max
	S1 offset	Probe S1 reading offset (valve 1)	0.0	Barg/psig	
Eic04	S1 probe (display)	Value read by probe S1 (valve 1)	---	Barg/psig	
	S2 offset	Probe S2 reading offset (valve 1)	0.0	°C/°F	
	S2 probe (display)	Value read by probe S2 (valve 1)	---	°C/°F	
Eic05	S3 offset	Probe S3 reading offset (valve 1)	0.0	Barg/psig	
	S3 probe (display)	Value read by probe S3 (valve 1)	---	Barg/psig	
	S4 offset	Probe S4 reading offset (valve 1)	0.0	°C/°F	
Eic06	S4 probe (display)	Value read by probe S4 (valve 1)	---	°C/°F	
	Alarm:	Abilita l'allarme sonda S1 (valvola 1)			
	EN:		EN/DIS.		
Eic07	Type:	Type of probe S1 (valve 1)	4-20mA		4-20mA / 4-20mA REMOTE / 4-20mA EXTERNAL / 0-5V RAT.
	Min.:	Minimum probe S1 reading (valve 1)	-1.0	Barg/psig	-20.0...200.0
	Max.:	Maximum probe S1 reading (valve 1)	9.3	Barg/psig	-20.0...200.0
Eic08	Alarm min.:	Minimum probe S1 alarm threshold (valve 1)	-1.0	Barg/psig	-20.0...200.0
	Alarm max.:	Maximum probe S1 alarm threshold (valve 1)	9.3	Barg/psig	-20.0...200.0
	Alarm:	Enable probe S2 alarm (valve 1)			
Eic09	EN:		EN/DIS.		
	Type:	Type of probe S2 (valve 1)	CAREL NTC		CAREL NTC / 0-10V EXT. SIGNAL / NTC SPKP**T0 / CAREL NTC-HT
	Alarm min.:	Minimum probe S2 alarm threshold (valve 1)	-50.0	°C/°F	-60.0...200.0
Eic10	Alarm max.:	Maximum probe S2 alarm threshold (valve 1)	105.0	°C/°F	-60.0...200.0
	Alarm:	Enable probe S3 alarm (valve 1)			
	EN:		EN/DIS.		
Eic11	Type:	Type of probe S3 (valve 1)	4-20mA		4-20mA / 4-20mA REMOTE / 4-20mA EXTERNAL / 0-5V RAT.
	Min.:	Minimum probe S3 reading (valve 1)	-1.0	Barg/psig	-20.0...200.0
	Max.:	Maximum probe S3 reading (valve 1)	30.0	Barg/psig	-20.0...200.0
Eic12	Alarm min.:	Minimum probe S3 alarm threshold (valve 1)	-1.0	Barg/psig	-20.0...200.0
	Alarm max.:	Maximum probe S3 alarm threshold (valve 1)	30.0	Barg/psig	-20.0...200.0
	Alarm:	Enable probe S4 alarm (valve 1)			
Eic13	EN:		EN/DIS.		
	Type:	Type of probe S4 (valve 1)	CAREL NTC		CAREL NTC / NTC SPKP**T0 / CAREL NTC-HT
	Alarm min.:	Minimum probe S4 alarm threshold (valve 1)	-50.0	°C/°F	-60.0...200.0
Eic14	Alarm max.:	Maximum probe S4 alarm threshold (valve 1)	105.0	°C/°F	-60.0...200.0

Mask index	Display description	Description	Default	UOM	Values
Eic08	ID1 configuration:	Configuration of action of digital input 1 on driver (valve 1)	REG. BACKUP		DISABLED / REG. SAFETY / REG. BACKUP / START/STOP REG. / VALVE FORCED 100% OPEN / BATTERY ALARM MNG. / VALVE REGULATION OPT. AFTER DEFROST
	ID2 configuration:	Configuration of action of digital input 2 on driver (valve 1)	DISABLED		DISABLED / REG. SAFETY / REG. BACKUP / START/STOP REG. / VALVE FORCED 100% OPEN / BATTERY ALARM MNG. / VALVE REGULATION OPT. AFTER DEFROST
Eic09	DI1:	Digital input 1 status (valve 1)	---		
	DI2:	Digital input 2 status (valve 1)	---		
Eic10	Valve A relay config.:	Configuration of digital output1 (valve 1)	ALARM RELAY		DISABLED / ALARM RELAY / SOLENOID VALVE RELAY / VALVE + ALARM RELAY / REVERSED ALARM RELAY / VALVE POSITION RELAY
Eic11	Valve B relay config.:	Configuration of digital output 2 (valve 1)	ALARM RELAY		DISABLED / ALARM RELAY / SOLENOID VALVE RELAY / VALVE + ALARM RELAY / REVERSED ALARM RELAY / VALVE POSITION RELAY
Eic12	S1 offset	Probe S1 reading offset (valve 2)	0.0	Barg/psig	
	S1 probe (display)	Value read by probe S1 (valve 2)	---	Barg/psig	
	S2 offset	Probe S2 reading offset (valve 2)	0.0	°C/°F	
	S2 probe (display)	Value read by probe S2 (valve 2)	---	°C/°F	
Eic13	S3 offset	Probe S3 reading offset (valve 2)	0.0	Barg/psig	
	S3 probe (display)	Value read by probe S3 (valve 2)	---	Barg/psig	
	S4 offset	Probe S4 reading offset (valve 2)	0.0	°C/°F	
	S4 probe (display)	Value read by probe S4 (valve 2)	---	°C/°F	
Eic14	Alarm:	Enable probe S1 alarm (valve 2)			
	EN:		EN./DIS.		
	Type:	Type of probe S1 (valve 2)	4-20mA		4-20mA / 4-20mA REMOTE / 4-20mA EXTERNAL / 0-5V RAT.
	Min.:	Minimum probe S1 reading (valve 2)	-1.0	Barg/psig	-20.0...200.0
	Max.:	Maximum probe S1 reading (valve 2)	9.3	Barg/psig	-20.0...200.0
	Alarm min.:	Minimum probe S1 alarm threshold (valve 2)	-1.0	Barg/psig	-20.0...200.0
Eic15	Alarm max.:	Maximum probe S1 alarm threshold (valve 2)	9.3	Barg/psig	-20.0...200.0
	Alarm:	Enable probe S2 alarm (valve 2)			
	EN:		EN./DIS.		
	Type:	Type of probe S2 (valve 2)	CAREL NTC		CAREL NTC / 0-10V EXT. SIGNAL / NTC SPKP**T0 / CAREL NTC-HT
	Alarm min.:	Minimum probe S2 alarm threshold (valve 2)	-50.0	°C/°F	-60.0...200.0
	Alarm max.:	Maximum probe S2 alarm threshold (valve 2)	105.0	°C/°F	-60.0...200.0
Eic16	Alarm:	Enable probe S3 alarm (valve 2)			
	EN:		EN./DIS.		
	Type:	Type of probe S3 (valve 2)	4-20mA		4-20mA / 4-20mA REMOTE / 4-20mA EXTERNAL / 0-5V RAT.
	Min.:	Minimum probe S3 reading (valve 2)	-1.0	Barg/psig	-20.0...200.0
	Max.:	Maximum probe S3 reading (valve 2)	30.0	Barg/psig	-20.0...200.0
	Alarm min.:	Minimum probe S3 alarm threshold (valve 2)	-1.0	Barg/psig	-20.0...200.0
Eic17	Alarm max.:	Maximum probe S3 alarm threshold (valve 2)	30.0	Barg/psig	-20.0...200.0
	Alarm:	Enable probe S4 alarm (valve 2)			
	EN:		EN./DIS.		
	Type:	Type of probe S4 (valve 2)	CAREL NTC		CAREL NTC / NTC SPKP**T0 / CAREL NTC-HT
	Alarm min.:	Minimum probe S4 alarm threshold (valve 2)	-50.0	°C/°F	-60.0...200.0
	Alarm max.:	Maximum probe S4 alarm threshold (valve 2)	105.0	°C/°F	-60.0...200.0
Eic18	ID1 configuration:	Configuration of action of digital input 1 on driver (valve 2)	REG. BACKUP		DISABLED / REG. SAFETY / REG. BACKUP / START/STOP REG. / VALVE FORCED 100% OPEN / BATTERY ALARM MNG. / VALVE REGULATION OPT. AFTER DEFROST
	ID2 configuration:	Configuration of action of digital input 2 on driver (valve 2)	DISABLED		DISABLED / REG. SAFETY / REG. BACKUP / START/STOP REG. / VALVE FORCED 100% OPEN / BATTERY ALARM MNG. / VALVE REGULATION OPT. AFTER DEFROST
Eic19	DI1:	Digital input 1 status (valve 2)	---		
	DI2:	Digital input 2 status (valve 2)	---		
Eic20	Valve A relay config.:	Configuration of digital output1 (valve 2)	ALARM RELAY		DISABLED / ALARM RELAY / SOLENOID VALVE RELAY / VALVE + ALARM RELAY / REVERSED ALARM RELAY / VALVE POSITION RELAY
Eic21	Valve B relay config.:	Configuration of digital output 2 (valve 2)	ALARM RELAY		DISABLED / ALARM RELAY / SOLENOID VALVE RELAY / VALVE + ALARM RELAY / REVERSED ALARM RELAY / VALVE POSITION RELAY
Eid02	Valve A opening at start-up	Valve opening at start of control (valve 1)	50	%	0...100
Eid04	Valve A opened in stand-by	Enable valve opening with control not active (valve 1)	NO		NO/YES
	Start-up delay after defrost	Start control delay after defrost (valve 1)	10	min	0...60
	Valve A preposit. delay	Stationary time when valve pre-positions (valve 1)	6	s	0...18000

Mask index	Display description	Description	Default	UOM	Values
Eid06	Prop Gain:	Control proportional gain (valve 1)	15.0		0.0...800.0
	Integral time:	Control integral time (valve 1)	150	s	0...1000
	Derivat.time:	Control derivative time (valve 1)	5.0	s	0...1000
Eid08	LowSH protect.:	Integral time with low superheat protection (valve 1)	10.0	s	0.0...800.0
	LOP protection:	Integral time with low operating pressure protection (valve 1)	10.0	s	0.0...800.0
	MOP protection:	Integral time with maximum operating pressure protection (valve 1)	20.0	s	0.0...800.0
Eid10	Threshold:	High condensing temperature protection activation threshold (valve 1)	30.0	°C/°F	-60.0...200.0
	Integr.time:	Integral time with high condensing temperature protection (valve 1)	0.5	s	0.0...800.0
	Alarm timeout	High condensing temperature alarm delay (valve 1)	600	s	0...18000
Eid11	LowSH:	Low superheat alarm delay (valve 1)	300	s	0...18000
	LOP:	Low operating pressure alarm delay (valve 1)	300	s	0...18000
	MOP:	Maximum operating pressure alarm delay (valve 1)	600	s	0...18000
Eid13	Threshold	Low suction temperature protection threshold (valve 1)	-50.0	°C/°F	-60.0...200.0
	Timeout	Low suction temperature alarm delay (valve 1)	300	s	0...18000
Eid15	Valve A opening at start-up	Valve opening at start of control (valve 2)	50	%	0...100
Eid17	Valve A opened in stand-by	Enable valve opening with control not active (valve 2)	NO		NO/YES
	Start-up delay after defrost	Start control delay after defrost (valve 2)	10	min	0...60
	Valve A preposit. delay	Stationary time when valve pre-positions (valve 2)	6	s	0...18000
Eid19	Prop Gain:	Control proportional gain (valve 2)	15.0		0.0...800.0
	Integral time:	Control integral time (valve 2)	150	s	0...1000
	Derivat.time:	Control derivative time (valve 2)	5.0	s	0...1000
Eid21	LowSH protect.:	Integral time with low superheat protection (valve 2)	10.0	s	0.0...800.0
	LOP protection:	Integral time with low operating pressure protection (valve 2)	10.0	s	0.0...800.0
	MOP protection:	Integral time with maximum operating pressure protection (valve 2)	20.0	s	0.0...800.0
Eid23	Threshold:	High condensing temperature protection activation threshold (valve 2)	30.0	°C/°F	-60.0...200.0
	Integr.time:	Integral time with high condensing temperature protection (valve 2)	0.5	s	0.0...800.0
	Alarm timeout	High condensing temperature alarm delay (valve 2)	600	s	0...18000
Eid24	LowSH:	Low superheat alarm delay (valve 2)	300	s	0...18000
	LOP:	Low operating pressure alarm delay (valve 2)	300	s	0...18000
	MOP:	Maximum operating pressure alarm delay (valve 2)	600	s	0...18000
Eid26	Threshold	Low suction temperature protection threshold (valve 2)	-50.0	°C/°F	-60.0...200.0
	Timeout	Low suction temperature alarm delay (valve 2)	300	s	0...18000
Eie02	Min.steps	Minimum step configuration, valve 1	50		0...9999
	Max.steps	Maximum step configuration, valve 1	480		0...9999
	Closing steps	Closing step configuration, valve 1	500		0...9999
Eie04	Min.steps	Minimum step configuration, valve 2	50		0...9999
	Max.steps	Maximum step configuration, valve 2	480		0...9999
	Closing steps	Closing step configuration, valve 2	500		0...9999
Eif01	Enable EVD in PLB x	Enable the EVD management on current board	NO		NO/YES
	EVD valves number	Number of drivers managed	1		1 / 2
	EVS 1 Address	Serial address of driver 1	198		0...207
	EVS 2 Address	Serial address of driver 2	199		0...207
Eif02	Defaults:	Run driver parameter setting procedure	NO		
	Force Parameters:	Override driver parameter settings	NO		
	Regulation based on:	Select cooling capacity used for control	LINE 1 COMP		LINE 1 COMP. / LINE 2 COMP
Eif03	Valve:	Type of valve connected to the driver	CAREL EXV		USER DEFINED / CAREL EXV / ALCO EX4 / ALCO EX5 / ALCO EX6 / ALCO EX7 / ALCO EX8 CAREL RECOMMENDED / ALCO EX8 ALCO SPECIFICATION / SPORLAN SEI 0.5-11 / SPORLAN SER 1.5-20 / SPORLAN SEI 30 / SPORLAN SEI 50 / SPORLAN SEH 100 / SPORLAN SEH 175 / Danfoss ETS 12.5-25B / Danfoss ETS 50B / Danfoss ETS 100B / Danfoss ETS 250 / Danfoss ETS 400 / TWO CAREL EXV TOGETHER / SPORLAN SER(I) G, J, K / Danfoss CCM 10-20-30 / Danfoss CCM 40
Eif05	Main Regulation:	Main control for the valve, for details refer to manual +0300005EN	R404 CONDENSER FOR SUBCRITICAL CO2		Possible control functions in manual +0300005EN
	Auxiliary regulation:	Safety or auxiliary control	INVERSE HIGH CONDENS. TEMP. PROTECTION ON S3		Possible control functions in manual +0300005EN
Eif06	Auxiliary refrigerant:	Refrigerant used for P -> T conversion of probe S3 with high condensing temperature protection	R744		
Eif09	S1 probe alarm manag:	Type of action in the event of probe S1 fault	VALVE AT FIXED POS.		NO ACTION / VALVE FORCE CLOSED / VALVE AT FIXED POS / USE BACKUP S3
	S2 probe alarm manag:	Type of action in the event of probe S2 fault	VALVE AT FIXED POS.		NO ACTION / VALVE FORCE CLOSED / VALVE AT FIXED POS / USE BACKUP S4
Eif11	DC power supply	Configure the type of power supply used for the driver	NO		NO / YES

Mask index	Display description	Description	Default	UOM	Values
Eif12	Valve:	Type of valve connected to the driver	CAREL EXV		USER DEFINED / CAREL EXV / ALCO EX4 / ALCO EX5 / ALCO EX6 / ALCO EX7 / ALCO EX8 CAREL RECOMMENDED / ALCO EX8 ALCO SPECIFICATION / SPORLAN SEI 0.5-11 / SPORLAN SER 1.5-20 / SPORLAN SEI 30 / SPORLAN SEI 50 / SPORLAN SEH 100 / SPORLAN SEH 175 / Danfoss ETS 12.5-25B / Danfoss ETS 50B / Danfoss ETS 100B / Danfoss ETS 250 / Danfoss ETS 400 / TWO CAREL EXV TOGETHER / SPORLAN SER(I) G, J, K / Danfoss CCM 10-20-30 / Danfoss CCM 40
Eif14	Main Regulation:	Main control for the valve, for details refer to manual +0300005EN	R404 CONDENSER FOR SUBCRITICAL CO2		Possible control functions in manual +0300005EN
	Auxiliary regulation:	Safety or auxiliary control	INVERSE HIGH CONDENS. TEMP. PROTECTION ON S3		Possible control functions in manual +0300005EN
Eif15	Auxiliary refrigerant:	Refrigerant used for P -> T conversion of probe S3 with high condensing temperature protection	R744		
Eif18	S1 probe alarm manag:	Type of action in the event of probe S1 fault	VALVE AT FIXED POS.		NO ACTION / VALVE FORCE CLOSED / VALVE AT FIXED POS / USE BACKUP S3
	S2 probe alarm manag:	Type of action in the event of probe S2 fault	VALVE AT FIXED POS.		NO ACTION / VALVE FORCE CLOSED / VALVE AT FIXED POS / USE BACKUP S4
Eif20	DC power supply	Configure the type of power supply used for the driver	NO		NO / YES

The following parameters refer to line 2, for details see the corresponding parameters for line 1 above

Eaba04	---	Oil temperature probe position (line 2)	B1	---	---, B1...B10 (****)
	---	Oil temperature probe type (line 2)	4-20mA	---	---
	---	Oil temperature probe value (line 2)	---	---	---
	---	Oil temperature probe max. limit (line 2)	30.0 barg	---	---
	---	Oil temperature probe min. limit (line 2)	0.0 barg	---	---
	---	Oil temperature probe adjustment (line 2)	0.0 barg	---	---
Eabb04	Oil pumps number	Number of oil pumps for common oil cooler (line 2)	0	---	0 to 1 (digital input) 0 to 2 (Digital outputs)
	Enable Aout pump	Enable AO of common oil cooler pump (line 2)	YES	---	NO (Digital outputs) YES (digital input)
Ebba01	DO	Subcooling valve DO position (line 2)	---	---	---
	Status (display only)	Status of subcooling valve DO (line 2)	---	---	---
	Logic	Logic of subcooling valve (line 2)	NO	---	Closed / Open NC / NO
	Function (display only)	Subcooling valve function status (line 2)	---	---	Not active / Active
Ebbb01	Subcooling control	Enable subcooling function (line 2)	NO	---	NO / YES
	---	Subcooling control type (line 2)	COND& LIQUID TEMP.	---	COND&LIQUID TEMP. LIQUID TEMP. ONLY
	Threshold	Threshold for subcooling control (line 2)	0.0 °C	---	---
Ecbb04	Subcool.value (display only)	Value of subcooling (line 2)	0.0 °C	---	---
	---	---	---	---	---
	Economizer	Enable economizer function (line 2)	NO	---	NO / YES
	Compr.Power Thr.	Capacity percent threshold for economizer activation (line 2)	0	%	0...100
Edba01	Press.Lim.	Condensing temperature threshold for economizer activation (line 2)	0.0 °C	---	---
	Disch.T.Thr.	Discharge temperature threshold for economizer activation (line 2)	0.0 °C	---	---
Edba01	---	Compressor 1 discharge temperature probe position (line 2)	B1	---	---
	---	Compressor 1 discharge temperature probe type (line 2)	4-20mA	---	---
	---	Compressor 1 discharge temperature probe value (line 2)	---	---	---
	Upper value	Compressor 1 discharge temperature probe max. limit (line 2)	30.0 barg	---	---
Edbb01	Lower value	Compressor 1 discharge temperature probe min. limit (line 2)	0.0 barg	---	---
	Calibration	Compressor 1 discharge temperature probe adjustment (line 2)	0.0 barg	---	---
Eeba02	---	---	---	---	---
	Liquid Injection	Enable liquid injection function (line 2)	DIS	---	DIS / EN
	Threshold	Liquid injection setpoint (line 2)	70.0 °C	---	---
Eebb01	Differential	Liquid injection differential (line 2)	5,0	---	---
	---	---	---	---	---
	DI	Heat recovery from digital input DI position (line 2)	---	---	---
Egba01	Status	Status of heat recovery DI (line 2)	---	---	---
	Logic	Logic of heat recovery DI (line 2)	NC	---	NC / NO
Egba01	Function	Status of heat recovery from digital input DI function (line 2)	---	---	Not active / Active
	Enable Heat Reclaim	Enable heat recovery function (line 2)	NO	---	NO / YES
Egba01	---	---	---	---	---
	DI	ChillBooster fault DI position (line 2)	---	---	---
	Status	Status of ChillBooster fault DI (line 2)	---	---	---
	Logic	Logic of ChillBooster fault DI (line 2)	NC	---	NC / NO
	Function	Status of ChillBooster fault DI (line 2)	---	---	Not active / Active

Mask index	Display description	Description	Default	UOM	Values
...
Egbb01	Device present Deactivation when fan-power falls under	ChillBooster function enable (line 2) Fans capacity under which ChillBooster is deactivated (line 2)	NO 95	--- %	NO / YES 0...100
...

Mask index	Display description	Description	Default	UOM	Values
------------	---------------------	-------------	---------	-----	--------



F.settings

Faaa01	Summer/Winter Special days Holiday periods	Enable Summer/Winter period management (line 1) Enable special days management (line 1) Enable holiday period management (line 1)	NO NO NO	--- --- ---	NO / YES NO / YES NO / YES
Faaa02	Begin End	Summer period beginning date (line 1) Summer period end date (line 1)	--- ---	--- ---	01/Gen...31/Dic 01/Gen...31/Dic
Faaa03	Day 01	Special day 1 date (line 1)	---	---	01/Gen...31/Dic
...
Faaa04	Day 10	Special day 10 date (line 1)	---	---	01/Gen...31/Dic
Faaa05	P1	Holiday period P1 beginning date (line 1)	---	---	01/Gen...31/Dic
	---	Holiday period P1 end date (line 1)	---	---	01/Gen...31/Dic
	---	---	---	---	---
	P5	Holiday period P5 beginning date (line 1)	---	---	01/Gen...31/Dic
Faaa05	---	Holiday period P5 end date (line 1)	---	---	01/Gen...31/Dic
	---	---	---	---	---
Faab01	Date format	Date format	DD/MM/YY	---	DD/MM/YY MM/DD/YY YY/MM/DD
Faab02/Faab03/ Faab04	Hour	Hour and minute
	Date	Date
	Day (display only)	Day of the week calculated from current date	Monday... Sunday
Faab05	Daily saving time	Enable daylight saving time	DISABLE	---	DISABLE / ENABLE
	Transition time	Offset time	60	---	0 to 240
	Start, ...	Starting week, day and month and hour for daylight saving time
	End, ...	End week, day and month and hour for daylight saving time
Fb01	Language	Current language	ENGLISH	---	...
Fb02	Disable language mask at start-up	Disable the change language screen at start-up	YES	---	NO / YES
Fb03	Countdown	Starting value for countdown, time change language screen active.	60	s	0...60
	Main mask selection	Main screen selection	LINE 1	---	LINE 1 / LINE 2 DOUBLE SUCTION DOUBLE CONDENSER
Fca01	Address	Address of the controller in a supervisory system network (line 1)	196	---	0 to 207
	Protocol	Supervisor communication protocol (line 1)	pRACK MANAGER	---	-- CAREL SLAVE LOCAL CAREL SLAVE REMOTE MODBUS SLAVE pRACK MANAGER CAREL SLAVE GSM
	Baudrate	Supervisor communication baud rate (line 1)	19200	---	1200 to 19200
Fca02	Address	Address of the controller in a supervisory system network (line 1)	1	---	0...207
	Protocol	Supervisor communication protocol (line 1)	CAREL	---	-- CAREL SLAVE LOCAL MODBUS SLAVE pRACK MANAGER
	Baudrate	Supervisor communication baud rate (line 1)	19200	---	1200...19200
Fd01	Insert password	Password	0000	---	0...9999
Fd02	Logged as (display only)	Current password level	---	---	User, Service, Manufacturer
	Logout	Logout	NO	---	NO / YES
Fd03	User	User password	0000	---	0...9999
	Service	Service password	1234	---	0...9999
	Manufacturer	Manufacturer password	1234	---	0...9999

The following parameters refer to line 2, for details see the corresponding parameters for line 1 above

Fcb01	Address	Enable summer/winter period management (line 2)	196	---	0 to 207
	Protocol	Enable special days management (line 2)	pRACK MANAGER	---	-- CAREL SLAVE LOCAL CAREL SLAVE REMOTE MODBUS SLAVE pRACK MANAGER CAREL SLAVE GSM
Fcb01	Baudrate	Enable holiday period management (line 2)	19200	---	1200 to 19200
	Address	Enable summer/winter period management (line 2)	1	---	0...207
	Protocol	Enable special days management (line 2)	---	---	-- CAREL SLAVE LOCAL MODBUS SLAVE pRACK MANAGER
	Baudrate	Enable holiday period management (line 2)	19200	---	1200...19200

Mask index	Display description	Description	Default	UOM	Values
------------	---------------------	-------------	---------	-----	--------



G.Safety

Gba01	Prevent enable	Enable condensing pressure prevent (line 1)	NO	---	NO / YES
Gba02	Setpoint	Condensing pressure prevent threshold (line 1)	0.0 barg (**)
	Differential	Condensing pressure prevent differential (line 1)	0.0 barg	...	0.0 to 99.9
	Decrease compressor power time	Decreasing capacity time (line 1)	0	s	0...999
Gba03	Enable Heat Reclaim as first prevent step	Enabling heat recovery as first stage for condensing HP prevent (line 1)	NO	---	NO / YES
	Offset HeatR.	Offset between heat recovery and prevent setpoint (line 1)	0.0 barg	...	0.0 to 99.9

Mask index	Display description	Description	Default	UOM	Values
Gba04	Enable ChillBooster as first prevent step	Enable ChillBooster as first stage for condensing HP prevent (line 1)	NO	---	NO / YES
	Offset Chill.	Offset between ChillBooster and prevent setpoint (line 1)	0.0 barg	...	0.0 to 99.9
Gba05	Prevent max.num	Maximum number of prevent allowed before locking compressor (line 1)	3	---	1...5
	Prevent max.number evaluation time	Prevent maximum number evaluation time	60	h	0...999
	Reset automatic prevent	Reset number of prevent (line 1)	NO	---	NO / YES
Gba07	Max.num prevent	Maximum number of prevent allowed before locking compressor (line 1, auxiliary regulation)	3	---	1...5
	Tempo di valutaz.num. max prevent	Prevent maximum number evaluation time (auxiliary regulation)	60	h	0...999
	Riabilita prevent automatico	Reset number of prevent (line 1, auxiliary regulation)	NO	---	NO / SI
Gba08	Threshold:	Threshold for low pressure prevent with auxiliary regulation	0.5	Barg/psig	-1.0...150.0
	Band:	Differential for the prevent re-enter	0.1	Barg/psig	0.0...60.0
	Minimum Power request:	Minimum power request in prevent	20.0	%	0.0...100.0
Gba09	Align Pow.Req at the end of prevent	At the end of prevent action power request is calculated starting from the last request value and not from the value available before the prevent action	NO		NO / YES
	Use Suction UoM	Unit selection for prevent threshold and differential	NO		NO / YES
Gca01	Common HP type	Type of reset for common HP alarm (line 1)	AUTO	---	AUTO / MAN
	Common HP delay	Common high pressure delay (line 1)	10	s	0...999
Gca02	Common LP start delay	Low common condensing pressure delay at start up (line 1)	60	s	0...999
	Common LP delay	Low common condensing pressure delay during operation (line 1)	20	s	0...999
Gca03	Time of semi-automatic alarm evaluation	Period of LP evaluation (line 1)	120	min	0...999
	N° of reties before alarm becomes manual	Number of LP in period after which the alarm becomes manual (line 1)	5	---	0...999
Gca04	Liquid alarm delay	Liquid level alarm delay (line 1)	0	s	0...999
	Oil alarm delay	Common oil alarm delay (line 1)	0	s	0...999
Gca05	Output alarms relays activation with	Select alarm relay output activation for active alarms or alarms not reset	Active alarms		Active alarms Alarms not reset

The following parameters refer to line 2, for details see the corresponding parameters for line 1 above

Gbb01	Prevent enable	Enable condensing pressure prevent (line 2)	NO	---	NO / YES
...	---	...
Gcb01	Common HP type	Type of reset for common HP alarm (line 2)	AUTO	---	AUTO / MAN
	Common HP delay	Common high pressure delay (line 2)	10	s	0...999
...	---	...

Mask index	Display description	Description	Default	UOM	Values
H. Info					
H01 (display only)	Ver.	Software version and date	...	---	...
	Bios	Bios version and date	...	---	...
	Boot	Boot version and date	...	---	...
H02 (display only)	Board type	Type of hardware	...	---	...
	Board size	Hardware size	...	---	...
	Total flash	Flash memory size	---	kB	...
	RAM	RAM size	---	kB	...
	Built-In type	Type of built-in display	---	---	None / PGD1
	Main cycle	Number of cycles per second and software cycle time	---	cycles/s ms	...

Mask index	Display description	Description	Default	UOM	Values
I. Setup					
la01	Pre-configuration	Pre-configuration selected	01. RS2	---	--NOT USED-- 01. RS2 02. RS3 03. RS3p 04. RS3i 05. RS4 06. RS4i 07. SL3d 08. SL5d 09. SW1 10. SW2 11. SW3 12. d-RS2 13. d-RS3 14. d-RS4
la02 (disp. only)	Boards necessary	pLAN boards required for the selected pre-configuration	---	---	---
la03 (disp. only)	Suction line	Number of suction lines featured in the pre-configuration	---	---	0 to 2
	Condenser line	Number of condenser lines featured in the pre-configuration	---	---	0 to 2
la04 (display only)	Num.Comp. L1	Number of compressors featured in the pre-configuration (line 1)	...	---	1...12
	Comp.type L1	Type of compressors featured in the pre-configuration (line 1)	RECIPROCATING	---	RECIPROCATING / SCROLL SCREW
	Num.Comp. L2	Number of compressors featured in the pre-configuration (line 2)	...	---	1...12
la05 (display only)	Comp.type L2	Type of compressors featured in the pre-configuration (line 2)	RECIPROCATING	---	RECIPROCATING / SCROLL
	Num.alarms per comp.	Number of alarms for compressor featured in the pre-configuration	1/4 (*)	---	0 to 4/7 (*)
	Cond.Gen.Alarm	Enable common condenser alarm	EN	---	EN/DIS
	HP comm.pressostat	Enable common HP pressure switch	EN	---	EN/DIS
lb01	LP comm.pressostat	Enable common LP pressure switch	EN	---	EN/DIS
	Type of Installation	Type of system	SUCTION + CONDENSER	---	SUCTION / CONDENSER SUCTION + CONDENSER
lb02	Measure Units	Unit of measure	°C/barg	---	°C/barg / °F/psig

Mask index	Display description	Description	Default	UOM	Values
lb03	Compressors type	Type of compressors (line 1)	RECIPROCATING	---	RECIPROCATING SCROLL / SCREW
	Compressors number	Number of compressors (line 1)	2/3 (*)	---	1...6/12 (*)
lb04	Number of alarms for each compressor	Number of alarms for each compressor (line 1)	1	---	0 to 4/7 (*)
lb05	Modulate speed device	Modulating speed device for first compressor (line 1)	None	---	NONE / INVERTER ---/DIGITAL SCROLL(*) ---/STEPLESS*)
lb30	Compressors sizes	Compressors sizes (line 1)	SAME CAPACITY & SAME STAGE CONF.	---	SAME CAPAC&SAME STAGE CONF. SAME CAPAC&DIFF. STAGE CONF. DEFINE SIZES
lb34	S1	Enable size and size for compressor group 1 (line 1)	YES 10.0	--- kW	NO / YES 0.0...500.0
	---	...
lb35	S4	Enable size and size for compressor group 4 (line 1)	NO ---	--- kW	NO / YES 0.0...500.0
	---	...
lb36	S1	Enable stages and stages for compressor group 1 (line 1)	YES 100	--- %	NO / YES 100; 50/100; 50/75/100; 25/50/75/100; 33/66/100
	---	...
lb36	S4	Enable stages and stages for compressor group 4 (line 1)	NO ---	--- kW	NO / YES 100; 50/100; 50/75/100; 25/50/75/100; 33/66/100
	---	...
lb10	C01	Size group for compressor 1 (line 1) or presence of inverter	S1	---	S1...S4/INV
	---	...
lb10	C12	Size group for compressor 12 (line 1)	S1	---	S1...S4
	---	...
lb10	Compr.Manufacturer	Compressor manufacturer for screw compressors	Generic	---	GENERIC BITZER REFCOMP HANBELL
	Compressor series	Compressor series	... (***)	---	... (***)
lb11	Compressors sizes	Compressor sizes (line 1)	SAME CAPACITY	---	SAME CAPACITY / DEFINE SIZES
lb16	S1	Enable size and size for compressor group 1 (line 1)	YES ---	--- kW	NO / YES 0.0...500.0
	---	...
---	S4	Enable size and size for compressor group 4 (line 1)	NO ---	--- kW	NO / YES 0.0...500.0
	---	...
lb17	C01	Size group for compressor 1 (line 1) or presence of inverter	S1	---	S1...S4/INV
	---	...
lb20	C06	Size group for compressor 12 (line 1)	S1	---	S1...S4
	---	...
lb21	Compressors sizes	Compressors sizes (line 1)	SAME CAPACITY	---	SAME CAPACITY / DEFINE SIZES
	S1	Enable size and size for compressor group 1 (line 1)	YES ---	--- kW	NO / YES 0.0...500.0
lb22	---	...
	S4	Enable size and size for compressor group 4 (line 1)	NO ---	--- kW	NO / YES 0.0...500.0
lb40	C01	Size group for compressor 1 (line 1) or presence of inverter	S1	---	S1...S4/INV
	---	...
lb40	C12	Size group for compressor 6 (line 1)	S1	---	S1...S4
	---	...
lb40	Regulation by	Compressor control by temperature or pressure (line 1)	PRESSURE	---	PRESSURE / TEMPERATURE
	Measure unit	Unit of measure (line 1)	barg	---	...
lb40	Refrigerant	Type of refrigerant (suction Line 1)	R404A	---	R22 - R134a - R404A - R407C - R410A - R507A - R290 - R600 - R600a - R717 -R744 - R728 - R1270 - R417A - R422D -R413A - R422A - R423A - R407A - R427A - R245Fa - R407F - R32
	---	...
lb41	Regulation type	Compressor control type (line 1)	NEUTRAL_ZONE	---	PROPORTIONAL BAND NEUTRAL_ZONE
	Enable integral time action	Enable integral time for proportional suction line control (line 1)	NO	---	NO / YES
lb42	Setpoint	Setpoint without compensation (suction line 1)	3,5 barg	... (**)	... (**)
	Differential	Differential (suction line 1)	0,3 barg	... (**)	... (**)
lb43	Configure another suction line	Second suction line configuration	NO	---	NO / YES
lb45	Dedicated pRack board for suction line	Suction lines on different boards	NO	---	NO / YES
lb50	Compressors type	Type of compressors (line 2)	RECIPROCATING	---	RECIPROCATING / SCROLL
	Compressors number	Number of compressors (line 2)	3	---	1...12
lb51	Number of alarms for each compressor	Number of alarms for each compressor (line 2)	1	---	0 to 4
lb52	Modulate speed device	Modulating speed device for first compressor (line 2)	NONE	---	NONE INVERTER ---/DIGITAL SCROLL(*)
lb70	Compressors sizes	Compressors sizes (line 1)	SAME CAPACITY	---	SAME CAPAC&SAME STAGE CONF. SAME CAPAC&DIFF. STAGE CONF. DEFINE SIZES
lb74	S1	Enable size and size for compressor group 1 (line 1)	YES ---	--- kW	NO / YES 0.0...500.0
	---	...
lb74	S4	Enable size and size for compressor group 4 (line 1)	NO ---	--- kW	NO / YES 0.0...500.0
	---	...

Mask index	Display description	Description	Default	UOM	Values
lb75	S1	Enable stages and stages for compressor group 1 (line 1)	YES 100	---	NO / YES 100; 50/100; 50/75/100; 25/50/75/100; 33/66/100
	---	...
lb76	S4	Enable stages and stages for compressor group 4 (line 1))	NO ---	---	NO / YES S1...S4
	---	...
lb60	C01	Size group for compressor 1 (line 1) or presence of inverter	S1	---	S1...S4/INV
	---	...
lb61	C12	Size group for compressor 6 (line 1)	S1	---	S1...S4
	---	...
lb62	Compressors sizes	Compressors sizes (line 1)	SAME CAPACITY	---	SAME CAPACITY DEFINE SIZES
	---	...
lb61	S1	Enable size and size for compressor group 1 (line 1)	YES ---	---	NO / YES 0.0...500.0
	---	...
lb62	S4	Enable size and size for compressor group 4 (line 1)	NO ---	---	NO / YES 0.0...500.0
	---	...
lb80	C01	Size group for compressor 1 (line 1) or presence of inverter	S1	---	S1...S4/INV
	---	...
	C12	Size group for compressor 6 (line 1)	S1	---	S1...S4
lb80	Regulation by	Compressor control by temperature or pressure (line 1)	PRESSURE	---	PRESSURE / TEMPERATURE
	Measure unit	Unit of measure (line 1)	barg	---	...
	Refrigerant	Type of refrigerant (suction Line 1)	R404A	---	R22 - R134a - R404A - R407C - R410A - R507A - R290 - R600 - R600a - R717 -R744 - R728 - R1270 - R417A - R422D -R413A - R422A - R423A - R407A - R427A - R245Fa - R407F - R32
lb81	Regulation type	Compressor control type (line 1)	NEUTRAL ZONE	---	PROPORTIONAL BAND NEUTRAL ZONE
	Enable integral time action	Enable integral time for proportional suction line control (line 2)	NO	---	NO / YES
lb82	Setpoint	Setpoint without compensation (suction line 2)	3.5 barg	... (**)	... (**)
	Differential	Differential (suction line 2)	0.3 barg	... (**)	... (**)
lb90	Dedicated pRack board for condenser line	Suct.line(s) and cond.line(s) on different boards, that is, condenser line(s) on dedicated board	NO	---	NO / YES
lb91	Fans number	Number of fans (line 1)	3	---	0 to 16
lb92	Modulate speed device	Fan modulating speed device (line 1)	NONE	---	NONE INVERTER PHASE CONTROL
lb93	Regulation by	Fans control by temperature or pressure value (line 1)	PRESSURE	---	PRESSURE / TEMPERATURE
	Measure unit	Unit of measure (line 1)	barg	---	...
	Refrigerant	Type of refrigerant (condenser line 1)	R404A	---	R22 - R134a - R404A - R407C - R410A - R507A - R290 - R600 - R600a - R717 -R744 - R728 - R1270 - R417A - R422D -R413A - R422A - R423A - R407A - R427A - R245Fa - R407F - R32
lb94	Regulation type	Fan control type (line 1)	PROPORTIONAL BAND	---	PROPORTIONAL BAND NEUTRAL ZONE
	Enable integral time action	Enable integral time for proportional band control	NO	---	NO / YES
lb95	Setpoint	Setpoint without compensation (condenser line 1)	12,0 barg	... (**)	... (**)
	Differential	Differential (condenser line 1)	2,0 barg	... (**)	... (**)
lb96	Configure another condensing line	Second condenser line configuration	NO	---	NO / YES
lb1a	Fans number	Number of fans (line 2)	3	---	0...16
...	---	...
lb1e	Differential	Differential (condenser line 2)	2,0 barg	... (**)	... (**)
lc01	Type of Installation	Type of plant	SUCTION + CONDENSER	---	SUCTION CONDENSER SUCTION + CONDENSER
lc02	Measure Units	Unit of measure	°C/barg	---	°C/barg / °F/psig
lc03	Number of suction lines	Number of suction lines	1	---	0...2
lc04	Dedicated pRack board for suction line	Suction lines are on different boards	NO	---	NO / YES
lc05	Compressors type	Type of compressors (line 1)	RECIPROCATING	---	RECIPROCATING / SCROLL SCREW
	Compressors number	Number of compressors (line 1)	4	---	1...6/12 (*)
lc06	Compressors type	Type of compressors (line 2)	RECIPROCATING	---	RECIPROCATING / SCROLL SCREW
	Compressors number	Number of compressors (line 2)	0	---	1...6
lc07	Number of condensing lines	Number of condenser lines in the system	1	---	0...2
lc08	Line 1	Number of fans (line 1)	4	---	0...16
	Line 2	Number of fans (line 2)	0	---	0...16
lc09	Dedicated pRack board for condenser line	Condenser lines are on different boards	NO	---	NO / YES
lc10 (display only)	Boards necessary	pLAN boards required for the selected pre-configuration	---	---	---
ld01	Save configuration	Save Manufacturer configuration	NO	---	NO / YES
	Load configuration	Manual installation of Manufacturer configuration	NO	---	NO / YES
ld02	Restore Carel default	Manual installation of Carel default values	NO	---	NO / YES

Tab. 7.a

(*) Depending on the type of compressor
 (**) Depending on the unit of measure selected
 (***) Depending on the compressor manufacturer, see relative paragraph
 (****) Depending on the hardware size

8. ALARMS





pRack pR300 can manage both alarms relating to the status of the digital inputs and to operation of the system. For each alarm, the following are controlled:

- The actions on the devices, if necessary
- The output relays (one global and two with different priorities, if configured)
- The red LED on the terminal and the buzzer, where present
- The type of acknowledgement (automatic, manual, semiautomatic)
- Any activation delay

The complete list of alarms, with the related information as described above, is available in Appendix A.4.

8.1 Alarm management

All alarms feature the following behaviour:

- When an alarm is activated, the red LED flashes and the buzzer is activated (where present); the output relays corresponding to the global alarm and to any alarms with priority are activated (if configured)
- Pressing the  (Alarm) button, the red LED stays on steady, the buzzer is muted and the alarm screen is shown
- If there is more than one active alarm, these can be scrolled using  (Up)  (Down). This condition is signalled by an arrow at the bottom right of the screen
- Pressing the  (Alarm) button again for at least 3 seconds acknowledges the alarms manually, and these are cleared from the display unless others are active (they are saved in the log)

8.1.1 Priority



For certain alarms, the alarm output relay can be set with two types of priority:

- R1: serious alarm
- R2: normal alarm

The corresponding relays, once configured, are activated when an alarm with the corresponding priority occurs. For the other alarms, the priority is fixed and is associated by default with one of the two relays.

8.1.2 Acknowledgement



The alarms can have manual, automatic or semiautomatic acknowledgement:

- Manual: the alarm is acknowledged by pressing the  (Alarm) button twice, the first time displays the corresponding alarm screen and mutes the buzzer, the second (extended, for at least 3 seconds) cancels the alarm (which is saved in the log). If the alarm is still active, acknowledgement has no effect and the signal is shown again.
- Automatic: when the alarm condition ceases, the alarm is automatically reset, the LED comes on steady and the corresponding screen remains displayed until the  (Alarm) button is pressed and held; the alarm is saved in the log.
- Semiautomatic: acknowledgement is automatic, until a maximum number of activations in set time. If the number reaches the maximum set, acknowledgement becomes manual.

For manual acknowledgement, the functions associated with the alarm are not reactivated until acknowledgement has been completed, while for automatic acknowledgement they're reactivated as soon as the alarm condition ceases.

8.1.3 Log

The alarm log can be accessed:

- from branch G.a of the main menu
- by pressing the  (Alarm) button and then  (Enter) when there are no active alarms
- by pressing  (Enter) after having scrolled all the alarms.

The alarm log screens show:

1. Order of activation (no. 01 is the oldest alarm)
2. Hour and date the alarm was activated
3. Short description
4. Main values recorded at the moment the alarm was activated (suction pressure and condensing pressure)

 **Note:** A maximum of 50 alarms can be logged; after this limit any new events overwrite the oldest ones, which are therefore deleted.

8.2 Compressor alarms

The number of alarms for each compressor can be set during the configuration phase using the Wizard or subsequently from branch C.a.e/ C.b.e of the main menu. The number of alarms is the same for all the compressors on the same line.

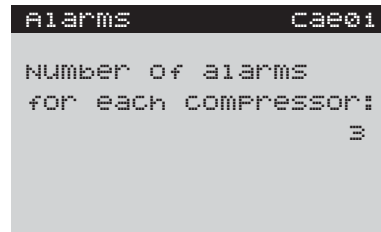

 **Note:** The maximum number of alarms that can be configured for each compressor depends not only on the type of compressor, but also on the size of pRack and the number of compressors fitted.

After having selected the number of alarms (maximum 4 for the reciprocating or scroll compressors and 7 for screw compressors), the settings can be configured for each alarm, choosing a description from the options shown in the table, the output relay, the type of reset, delay and priority. The effect of the alarm on the devices is set and involves stopping the compressor, except for the oil warning.

Possible descriptions for compressor alarms

Reciprocating or scroll	Screw
Generic	Generic
Overload	Overload
High pressure	High pressure
Low pressure	Low pressure
Oil	Oil
	Screw rotation
	Oil warning (Filter Blocked)

Tab. 8.a

An example of a screen for selecting the description of the alarm is shown in the figure:

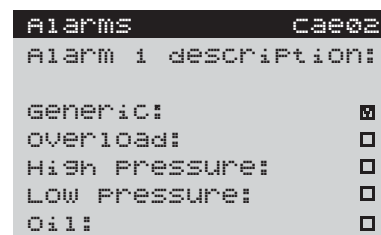

After having selected the 'generic' description, no other description can be selected. In general, the descriptions are divided into four groups:

- generic
- others (overload, oil, high pressure , low pressure)
- screw rotation
- oil warning

After a description has been selected for a certain group, descriptions from a different group can not be selected for that alarm.

For example, generic only, or overload + oil, or rotation only or overload + high pressure., etc. can be selected.

Each alarm will have one alarm screen, which will show all the descriptions associated to that alarm.

Based on the number of alarms selected, the descriptions associated by default are shown in the table below

Default descriptions based on the number of alarms

Number of alarms	Descriptions
1	Generic
2	Overload
	HP-LP
3	Overload
	HP-LP
	Oil
4	Overload
	HP
	LP
	Oil
5	Overload
	HP
	LP
	Oil
	Oil warning
6	Overload
	HP
	LP
	Oil
	Oil warning
	Rotation
7	Overload
	HP
	LP
	Oil
	Oil warning
	Rotation
	Generic

Tab. 8.b

Note: for oil alarms, special management is available whereby the alarm is interpreted as an oil level alarm. When the alarm is activated, a number of attempts are made to restore the level for a set time before the alarm is signalled and the compressor stopped; see paragraph 6.6.1 for details.

If a modulating device is used for the compressors, further alarms become available:

- compressor inverter warning, common for the entire suction line, when the device is an inverter
- oil sump temperature alarm, high discharge temperature and oil dilution, for Digital Scroll™ compressors

For each compressor, two alarm variables are sent to the supervisor, one for each priority. As well as the alarm signal, the description of the alarm is also sent to the supervisor, using the values shown in the table:

The supervisor can interpret the variables sent by pRack pR300 and provide the correct description of the alarm.

8.3 Pressure and prevent alarms

pRack pR300 can manage pressure alarms from a pressure switch or probe, according to the following diagram.

Alarms from pressure switch:

- Low suction pressure
- High condensing pressure

Alarms from probe:

- Low suction pressure
- High suction pressure
- Low condensing pressure
- High condensing pressure

One possible example for the low pressure alarms is shown in the figure:

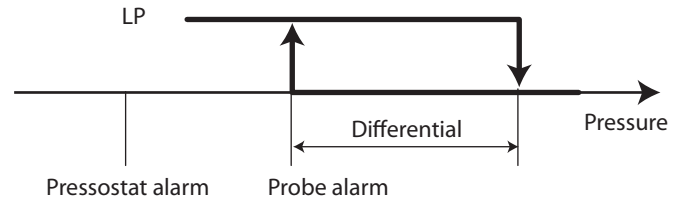

Fig. 8.a

In addition, the high pressure alarm features a prevent function, available by manually overriding the devices as well as using additional functions, such as heat recovery and ChillBooster.

Operation of the alarms and prevent function is described below.

8.3.1 Pressure alarms from pressure switch

The parameters corresponding to these alarms can be set in branch G.c.a/G.c.b of the main menu.

Low suction pressure from pressure switch

The low suction pressure alarm from pressure switch has the effect of stopping all the compressors without observing the various times, therefore when the digital input configured as low pressure switch is activated, all the compressors on the line affected are stopped immediately.

This alarm features semiautomatic reset, and both the monitoring time and the number of activations in the specified period can be set. If the number of activations is higher, reset becomes manual.

In addition, the delay after which the alarm is activated on both start-up and during operation can be set.

The delay at start-up only applies to unit start-up and not compressor power-up.

High condensing pressure from pressure switch

The high condensing pressure alarm from pressure switch has the effect of stopping all the compressors without observing the various times and forcing the fans on at maximum speed, therefore when the digital input configured as high pressure switch is activated, all the compressors on the line affected are stopped immediately and the fans operate at maximum output.

This alarm features manual or automatic reset, as configured by the user. The delay after which the alarm is activated can also be set

8.3.2 Pressure alarms from probe

The parameters corresponding to these alarms can be set in branch C.a.e/C.b.e of the main menu for the suction pressure and D.a.e/D.b.e for the condensing pressure.

For these types of alarms, reset is automatic and the activation threshold and differential can be set, as well as the type of threshold, which may be absolute or relative to the control set point. The figure shows an example of setting the threshold to relative.

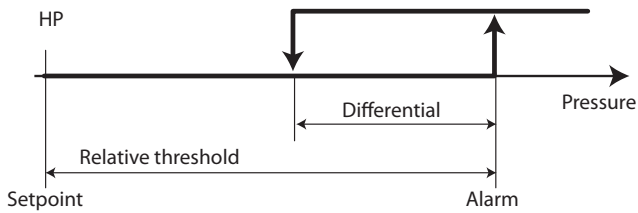

Fig. 8.b

Note: for temperature control, the alarms from probe are managed based on temperature even when pressure probes are fitted.

The effects of the different pressure alarms from probe are described below.

Low suction pressure from probe

The low suction pressure alarm from probe has the effect of stopping all the compressors, ignoring the times.

High suction pressure from probe

The high suction pressure alarm from probe has the effect of forcing all the compressors on, ignoring the control times, but observing the compressor protection times.

Low condensing pressure from probe

The low condensing pressure alarm from probe has the effect of stopping all the fans, ignoring the times.

High condensing pressure from probe

The high condensing pressure alarm from probe has the effect of forcing all the fans on and stopping all the compressors, ignoring the times.

8.3.3 High pressure prevention

pRack pR300 can manage 3 types of high condensing pressure prevention actions, involving:

- overriding the compressors and fans
- activating heat recovery
- activating ChillBooster

Prevent by overriding the compressors and fans

The parameters relating to this function can be set in branch G.b.a/G.b.b of the main menu.

The effect of this type of prevent action is to force all the fans on at maximum and switch all the compressors off, except for the minimum capacity stage, ignoring the control times but observing the compressor protection times. The minimum capacity stage means one compressor in the case of compressors without capacity control and modulation devices, or the minimum capacity stage for capacity-controlled compressors (e.g. 25%), or alternatively the minimum output of the modulation device in the case of inverters, Digital Scroll™ compressors or screw compressors with continuous modulation.

As well as the activation threshold, which is always absolute, and the activation differential, a compressor deactivation time can be set, corresponding to the time needed to switch off all the compressors, except for the minimum capacity stage.

In addition, both the monitoring time and the number of activations in the specified period can be set. If the number of activations is higher, reset becomes manual.

Prevent by activating heat recovery

The parameters corresponding to this function can be set in branch G.b.a/G.b.b of the main menu, if the heat recovery function is present.

As well as enabling the function, an offset from the activation threshold for the prevent by overriding devices function must be set. The activation differential for this function is the same as set for the prevent by overriding devices function.

When reaching the threshold, pRack pR300 activates the heat recovery function, if the conditions allow; see paragraph 6.6.3 for details.

Prevent by activating ChillBooster

The parameters relating to this function can be set in branch G.b.a/G.b.b of the main menu, if the ChillBooster function is present.

As well as enabling the function, an offset from the activation threshold for the prevent by overriding devices function must be set. The activation differential for this function is the same as set for the prevent by overriding devices function.

When reaching the threshold, pRack pR300 force activates the ChillBooster, if the conditions allow; see paragraph 6.6.5 for details.

The following figure illustrates the activation thresholds for the prevent function and the safety devices:

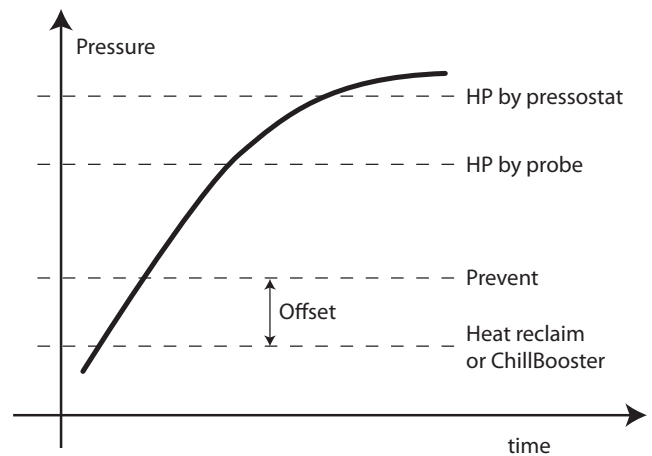

Fig. 8.c

8.3.4 Prevent low suction pressure

pR300 offers the possibility to reduce compressor capacity in the event of low suction pressure. The parameters relating to this function can be set in branch G.b.a/G.b.b of the main menu.

The effect of this function is to operate the compressors at a set percentage of capacity as soon as pressure falls below the prevent set point and related differential (screen Gab06)

In addition to the activation threshold, which is always absolute, and the activation differential, a compressor deactivation time can be set, corresponding to the time needed to switch off all the compressors except for the minimum capacity step.

The evaluation time and number of activations allowed in a certain time period can also be set. If the number of activations exceeds the setting, manual reset is required (screen Gab07)

When the prevent function is activated, an alarm icon is shown on the main screen, and a warning screen appears in the alarms.

Prevent low suction pressure with auxiliary control

Advanced configurations are available when using auxiliary control, so as to ensure a better response when activated.

If the suction pressure falls below the set threshold (screen Gba08), compressor capacity is reduced proportionally to the limit set point.

Normally, when the prevent function ends, the current capacity is instantly brought to the level needed to meet the control request.

If the parameter "Align request after prevent" is enabled (screen Gba09), the current request is aligned with the limit value.

9. SUPERVISORY AND COMMISSIONING SYSTEMS

pRack pR300 can be connected to various supervisory systems, specifically the Carel and Modbus communication protocols can be used. For the Carel protocol, the PlantVisor PRO and PlantWatch PRO models are available.

In addition, pRack pR300 can be connected to the pRack Manager commissioning software.

9.1 PlantVisor PRO and PlantWatch PRO supervisory systems

Connection to Carel PlantVisor PRO and PlantWatch PRO supervisor systems uses the RS485 card already fitted on some models of pRack pR300. For details on the models of card available, see Chapter 1.

Note: In general, the pRack boards that manage the suction lines must be fitted with the supervisor connection card, consequently boards with pLAN address 1 or 2.

Three different models of PlantVisor PRO and PlantWatch PRO are available, used to supervise system configurations with one or two lines:

- L1 – one line: can be used for system configurations with just one suction and/or condenser line.
- L2 – one line: can be used for system configurations with two suction and/or condenser lines, and the two suction lines are managed by separate boards.
- Two lines: can be used for system configurations with two suction and/or condenser lines, and the two suction lines are managed by the same board.

Important: model L2 – One line must be used only in association with model L1 – One line. For supervision of system configurations with just one line only model L1 – One line can be used.

Tutorial: the rule applied for using the models is summarised below:

- configuration with board with pLAN address 2 → separate models
- configuration without board with pLAN address 2 → one model only

A connection example for using PlantVisor PRO and PlantWatch PRO is shown in the figure.

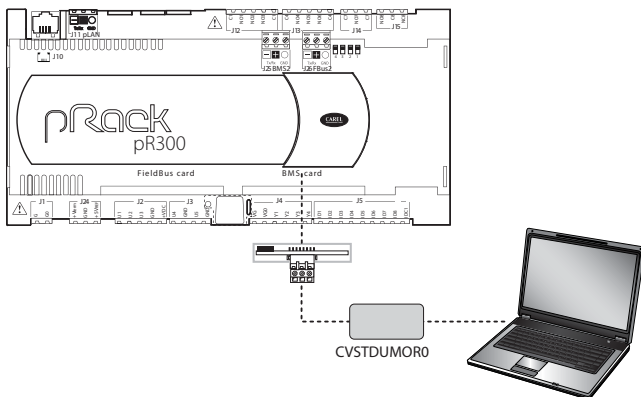

Fig. 9.a

The complete list of supervisor variables, with the corresponding addresses and descriptions, can be supplied upon request.

9.2 Commissioning software

pRack Manager is configuration and real-time monitoring software used to check the operation of pRack pR300, for commissioning, debug and maintenance operations.

The software is available on the internet at <http://ksa.CAREL.com> in the section “download à support à software utilities”. The installation includes, in addition to the program, the user manual and the necessary drivers.

pRack Manager can be used to set the configuration parameters, modify the values of volatile and permanent variables, save graphs of the main system values to file, manually manage the unit I/Os using simulation files and monitor/reset alarms on the unit where the device is installed.

pRack pR300 is able to virtualise all the inputs and outputs, both digital and analogue, therefore each input and output can be overridden by pRack Manager.

pRack Manager manages <file name>.DEV files that contain the user parameter configurations and that can be downloaded from the pRack pR300 board and then subsequently uploaded.

To use the pRack Manager program, a serial converter output RS485 with CVSTDUTLF0 (telephone connector) or CVSTDUMORO (3 pin terminal) must be connected to the board.

The connection to pRack Manager can be made:

1. Via the RS485 serial port used for the “pLAN” connection
2. Via the BMS serial port with RS485 serial card and activating the pRack Manager protocol by parameter on screen Fca01 or connecting pRack Manager and selecting SearchDevice = Auto (BMS or FB) on the “Connection settings” tab. In this case, the connection is established after around 15-20 seconds.

Important: the BMS serial port should only be used for monitoring the variables, while to update the software use the RS485 serial port dedicated to the pLAN connection.

The following figure shows an example of connection to the PC via the RS485 serial port used for the “pLAN” connection

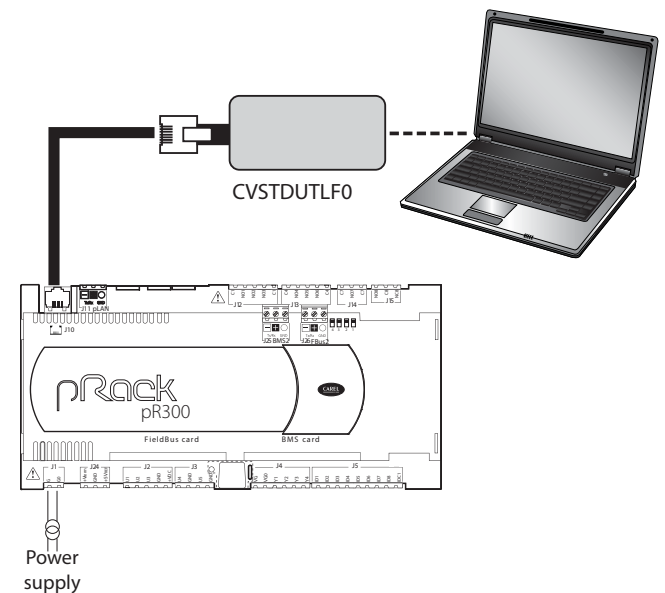

Fig. 9.b

Note: for further details see the pRack Manager program online help.

10. UPDATING THE SOFTWARE

The pRack pR300 boards are supplied with the software already loaded. If an update is required, the following can be used:

- pRack Manager
- SmartKey programming key

Note: The pRack pR300 software is protected by digital signature and cannot be loaded onto hardware other than pRack pR300 (e.g. pCO3), otherwise after 5 minutes of operation the software locks up, all the relays open and the warning "INVALID OEM IDENTIFIER" is shown.

The update files are available at <http://ksa.CAREL.com>.

Important: each version of the pRack pR300 software is associated with a specific controller firmware version (BIOS), therefore if updating the version, always check and where necessary update the BIOS on the board. The appropriate BIOS version is supplied together with the pRack pR300 update files.

10.1 Updating using pRack Manager

The software resident in the pRack pR300 boards can be updated from a PC.

For the connection procedure see Chapter 9, while for further details see the pRack Manager program online help.

Note: The pCOload program can also be used to update the pRack pR300 software, however Winload cannot be used.

10.2 Updating using SmartKey

The SMARTKEY programming key can copy the contents of one pRack pR300 board to another identical board, using the telephone connector on the terminal (the pLAN must be disconnected).

From a PC, with the SmartKey Programmer software running, the key can be configured to perform specific operations: acquire log files, program applications, etc.

The SmartKey Programmer software is installed together with pRack Manager.

The following figure shows the connection of the SmartKey to the PC using the PCOS00AKY0 converter.

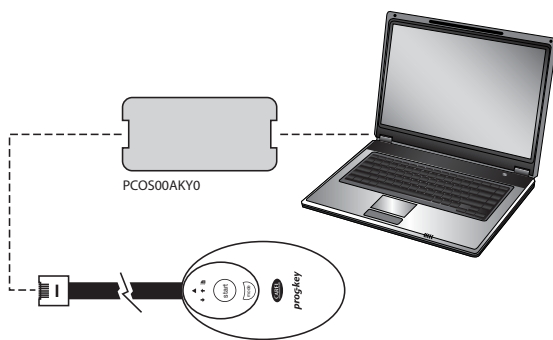

Fig. 10.a

Note: for further details on using the SmartKey, see the corresponding instruction sheet. For details on the SmartKey Programmer see the online manual.

10.3 Pendrive: operating instructions

10.3.1 File extensions, names and contents

Various types of files can be uploaded and downloaded and are distinguished by their extension.

File names

In order to be recognised, the names of the directories and files on the pendrive must have no more than 8 characters; the controller makes no distinction between upper-case and lower-case characters. However, during DOWNLOAD the names of the directories created by the controller on the pendrive are always in upper-case.

FILE TYPES FOR UPLOAD

File extension	Description
.IUP	Contains the definitions of the screens on the terminal
.BLB	Contains the application
.BIN	Contains the application (with pLAN table)
.BLX	Contains the Logique of atoms custom in C language
.GRP	Contains the graphics
.DEV	Contains the preset configuration parameter values
PVT,LCT	Contains the descriptions of the public variables to be logged. Generated by I Tool, this is used by the LogEditor module and must be loaded together with the LCT file

Downloaded files are saved in directories created automatically, with the following name format:

NAMXY_WZ

Where:

NAM: identifies the type of data downloaded (LOG for logs, BKP for the application, DEV for the buffer memory, CPY for all the data from the controller).

XY: progressive number from 0 to 99

WZ: controller pLAN address.

Example: a directory named LOG00_01 contains the log files (LOG) downloaded from a device whose pLAN address is 1. Since the key contained no directory of this type before download, it is indicated with 00.

Important: No more than 100 files of the same type can be downloaded to the pendrive, as the directories created can only be numbered with XY=00 to 99.

FILE TYPES FOR DOWNLOAD (controller pLAN address = 1)

File extension	Directory name	Description
.DWL	LOG00_01	Logged data
.DWL,.DEV,.LCT,.PVT	BKP00_01	Application
.DEV	DEV00_01	Non-volatile parameters
.DWL,.DEV,.LCT,.PVT	CPY00_01	All data on the controller

Tab. 10.c

The downloaded files to have fixed names. In particular, the application file is called "ppl-pRack.dwl", the BIOS file "bios-pRack.bin", the files containing the logs and related information are "logs.dwl", "logs.lot" and "logs.pvt", respectively. Finally, the buffer memory is saved to the file on the pendrive.

Menu access

The following are the steps for accessing the pendrive management menu. Procedure:

1. Connect the pendrive to the master port.

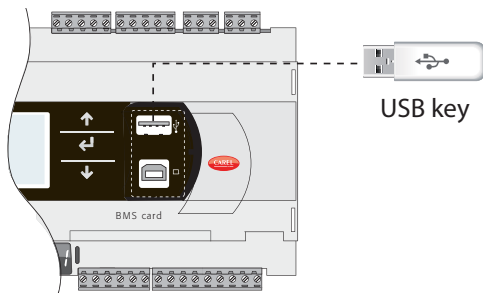

Fig. 10.b

2. Press Alarm and Enter together for 3 seconds to enter the option menu. Select FLASH/USB memory and press Enter to confirm.

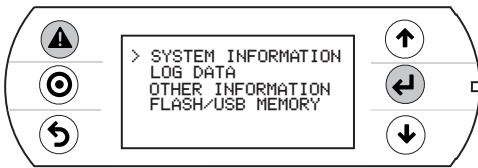

Fig. 10.c

3. Select USB pen drive and press Enter to confirm.

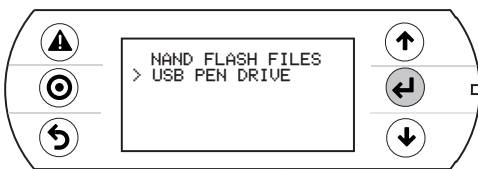

Fig. 10.d

Important: Wait a few seconds after the pendrive has been plugged in for it to be recognised by the controller. If the message "No USB disk or PC connected" is displayed momentarily with the request to connect a pendrive key or computer USB cable, wait a few seconds until the recognition message is shown ("USB disk found") and the following screen appears.

4. Select UPLOAD.



Fig. 10.e

10.3.2 Upload

An application plus BIOS or buffer memory (parameters) can be uploaded from the pendrive. The following modes are available: automatic, autorun and manual. Automatic and autorun modes require using configuration files.

Configuration file structure

Configuration files must start with the string "[FUNCTION]" followed by a string that identifies the function, as shown in the table.

Function	String
UPLOAD an application or a BIOS file plus an application	Upload application
UPLOAD non-volatile memory (.dev)	Upload non volatile memory
UPLOAD the entire contents of the pRack	Copy pRack upload

After the description of the desired function, various options are available:

1. To copy the complete contents of the directory, simply write the name of the directory (e.g. the entire contents of the CHILLER directory):

```
[FUNCTION]
Upload non volatile memory

[DIR]
CHILLER
```

2. To copy just 1 file in a directory, enter the file's name (e.g. the CHILLER.DEV file in the CHILLER directory).

```
[FUNCTION]
Upload non volatile memory

[DIR]
CHILLER

CHILLER.DEV
```

To show a string on the display describing the operation being performed, add the "[NAM]" instruction, followed by the string to display. The following file will display the string:

```
"UPL CHILLER.DEV"

[FUNCTION]
Upload non volatile memory

[DIR]
CHILLER

[NAM]
UPL CHILLER.DEV

CHILLER.DEV
```

3. To select only some of the files in the same directory, list them after a label. The following labels are allowed and **must be entered in the order shown in the table:**

UPLOAD file labels

No.	Label	File type	No.	Label	File type
1	[BIO] (*)	file.bin	6	[PVT]	file.pvt
2	[IUP]	file.iup	7	[LCT]	file.lct
3	[BIN]	file.bin, blb	8	[OED]	file.oed
4	[DEV]	file.dev	9	[SGN]	file.sgn
5	[GRP]	file.grp			

(*) BIO = BIOS file



Notes:

- to get the .bin file from the BIOS in the format available on <http://ksa.carel.com> (.os file), unzip the .os file;
- the [IUP] label can be followed by one or more ".iup" files.



Important:

- the order in which the file names are entered is fundamental and must not be changed;
- do not enter empty lines or spaces in the file (e.g. at the end of a line);
- each file after the last line of code must contain a "carriage return" character (CR↵), as shown in the following example.

Example: The following file will upload the BIOS and an application.

```
[FUNCTION] ↵
Upload application ↵
↵
[DIR] ↵
NEW AHU ↵
↵
[NAM] ↵
BIOS+APPL+LOGSv58B36 ↵
↵
bisn509.bin ↵
↵
[IUP] ↵
AHU_EN.iup ↵
AHU_IT.iup ↵
↵
[BIN] ↵
AHU.blb ↵
↵
[DEV] ↵
AHU.dev ↵
↵
[GRP] ↵
AHU.grp ↵
↵
[PVT] ↵
AHU.pvt ↵
↵
[LCT] ↵
AHU.lct ↵
```

10.3.3 Automatic upload

To automatically upload the parameter memory using the first configuration file shown in the preceding paragraph, access the system menu as previously described and proceed as follows:

1. Select automatic mode. A screen is shown describing the function of the buttons. Press Enter to confirm.

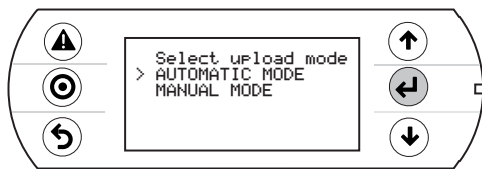

Fig. 10.f

2. Confirm by selecting Prg. A screen is displayed requesting confirmation to upload the non-volatile memory. Press Enter to confirm.

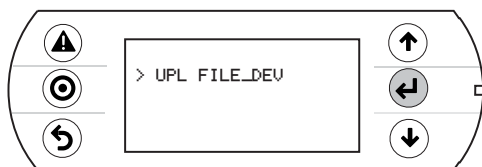

Fig. 10.g

3. At the end a message will ask the user to remove the pendrive.



Fig. 10.h

10.3.4 Upload in autorun mode

Uploading in autorun mode is a special case of uploading in automatic mode. Unlike automatic mode, the user must wait for a specific message to appear on the display to start or disable the operation described in the configuration file. To upload a file in autorun mode, a configuration file must be created and named "autorun.txt".

Example of uploading BIOS+application

The upload involves two steps: first the BIOS is updated and then the application. The information is shown on the pRack's built-in display and on the pGDE terminal, when both are featured.

Procedure:

1. Connect the pendrive to port A.

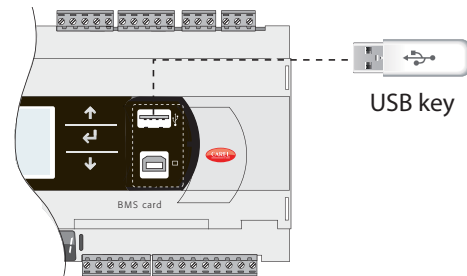

Fig. 10.i

2. After a few seconds, Autorun mode starts. Press Enter to confirm.

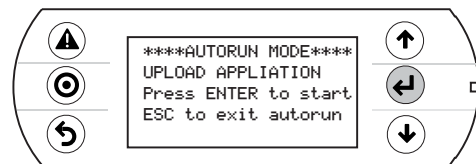

Fig. 10.j

3. The validity of the FW is checked and the BIOS is loaded.

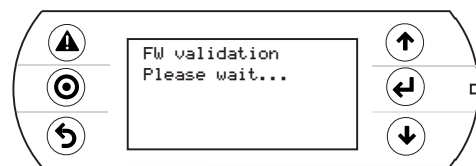

Fig. 10.k

4. The display flashes to indicate that after loading the new BIOS the controller is being reset.



Fig. 10.l

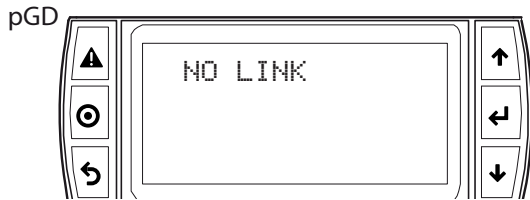

Fig. 10.m

5. The test phase starts.

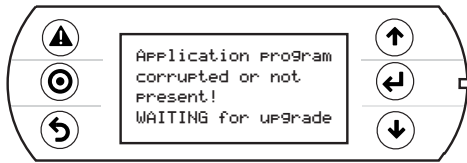

Fig. 10.n

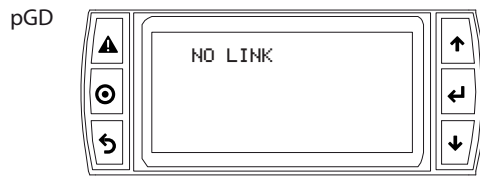

Fig. 10.o

6. The controller warns that no application has been loaded.

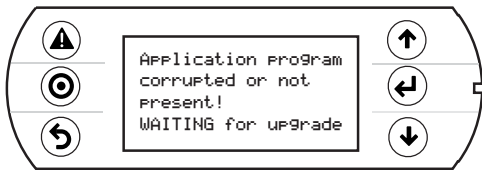

Fig. 10.p

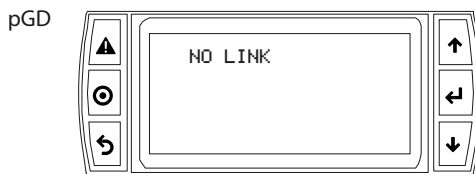

Fig. 10.q

7. The application update then starts.



Fig. 10.r

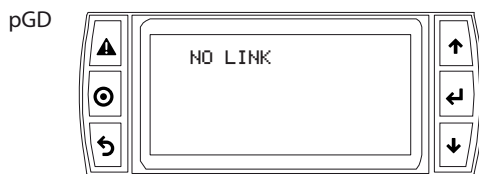

Fig. 10.s

8. Remove the pendrive. The update is complete. Wait for the display to stop flashing, indicating that the controller is being reset before restarting.



Fig. 10.t

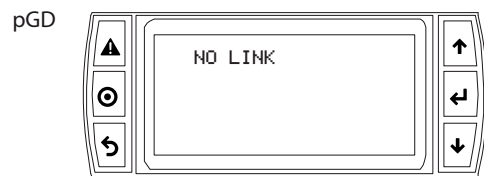

Fig. 10.u

! Important: As can be seen, when updating the BIOS and the application, the pGDE terminal shows the message "NO LINK", meaning that no connection is established. Do not remove the terminal and wait for the end of the update procedure, when the pGDE terminal replicates the messages on the built-in display.

▶ Note: Autorun run is especially useful in those cases in which the same operation needs to be performed on several controllers. For example, to load different applications on controllers connected in a pLAN network, only one autorun file needs to be created; this uploads the various directories contained on the pendrive based on the address of the controllers. The controller with address XY will only load the directory called "nomedir_XY" ["DirName_XY"]. The pendrive then only needs to be plugged into each controller to run the upload, confirming from the shared terminal.

10.3.5 Manual upload

To manually upload the contents of the pendrive the user must access the management menu from the system screens, selecting UPLOAD and then MANUAL. The files are selected by pressing ENTER when the cursor is on the desired file name. A selected file is marked by the symbol "*" on the left. Once the files have been selected (all in the same directory), press PRG to start the upload. To display the contents of a directory press ENTER. To go up one directory level press ESC. Once the upload has started, the messages shown on the screen are the same as in automatic and autorun mode.

10.3.6 Download

As mentioned above, the DOWNLOAD operation can be managed in two ways:

1. Manual mode: follow the steps described in the paragraph "Automatic upload" and select manual operation. Then each file must be selected and downloaded.
2. Autorun mode: prepare a file called "autorun.txt", containing a string that identifies the function to be performed.

Function	String
DOWNLOAD the application	Download application
DOWNLOAD non-volatile memory	Download non volatile memory (.dev)
DOWNLOAD the entire contents of the pRack	Copy pRack download

The result is the creation of files with the required extensions, which will be placed in the respective directories as described in the paragraph "File names". When the operation is completed, the display shows a message with the name of the directory created.



At the end, the screen shows:

P	C	O	W	E	B	C	O	N	F	I	G	E	N	A	B	L	E
U	p	d	a	t	e	c	o	m	p	l	e	t	e				
R	e	b	o	o	t	p	C	O	W	e	b	t	o				
a	p	p	l	y	n	e	w	s	e	t	t	i	n	g			

Configuring pConet

When you select "PCONET settings" the following screen will appear:

B	A	C	n	e	t	I	D	:									
						-	-	-	-	-	-	-					
B	A	C	n	e	t	b	a	u	d	:							
						-	-	-	-	-	-	-					

After a short time the fields are populated with the current parameters. The parameters can now be edited by selecting the respective fields using the ENTER button and setting the desired values using the UP/DOWN buttons. Pressing ENTER repeatedly will display all the parameters available, as listed in the following screen:

B	A	C	n	e	t	M	A	C	:		-	-	-				
M	a	x	M	a	s	t	e	r	s	:		-	-	-			
M	a	x	F	r	a	m	e	s	:		-	-	-	-			

Once the parameters have been chosen they can be updated following the procedure described for configuring pCOWeb.

10.5 Saving parameters between different software versions

The configuration parameters can be saved and loaded after having updated the software. The update requires the files relating to the new version being loaded (files with the following extensions: .iup, .blx, .blb, .grt, .dev) and the connection files (files with the following extensions: .2cf, .2ct, .2cd) for the installed version and the new version.

The connection files must be copied to the "2cf" directory under pRack Manager, for example C:\Program Files\CAREL\pRackManager\2cf.

The update procedure including saving the parameters is as follows (for details on the functions of the pRack Manager software see the online manual):

1. Switch the unit off from the user terminal or supervisor or digital input
2. Connect the PC where pRack Manager is installed using the pLAN serial (disconnect the terminal if necessary) and disconnect any BMS connections
3. Start the pRack Manager software
4. In the "Connection settings" panel, set Baud rate to "Auto" and SearchDevice to "Auto (pLAN)" and select the COM port under PortNumber (if necessary, use the Wizard to detect the correct COM)
5. In Commissioning/Settings select the .2cf file relating to the version on pRack pR300, e.g. 1.0
6. Power down pRack pR300, power up again and wait for the controller to come "On line"
7. In Device Configuration read all the variables and save them to an .txt file (required)
8. Update the software version on pRack pR300, selecting from pRack Load the following update files and selecting "Update graphic resources and "Enable zipped upload":
 - .iup (maximum 2 files)
 - .blx
 - .blb
 - ClearAllx.dev, where x is the pLAN address of the board being updated
9. Wait for the update procedure to end.
10. Power down, disconnect the PC and if necessary reconnect the terminal
11. Power up again and run a quick start-up procedure (pre-configurations or Wizard, confirming the default parameters)
12. Power down

13. Reconnect pRack Manager and power up again
14. In Commissioning/Settings select the .2cf file relating to the new version now loaded on pRack
15. From Device Configuration, import the previously saved .txt file and write all the variables
16. Power down, disconnect the PC and reconnect the terminal if necessary
17. Power up again

At the end of the procedure, pRack pR300 will be programmed with the updated software and the previously configured parameters.

Important: if using the BMS serial port to read/write variables, pRack pR300 continues operating, and therefore software malfunctions may occur. Consequently, use the RS485 serial port provided for the pLAN connection when carrying out the software update operations described above.

Note: to update the software without maintaining the parameter configuration, simply complete steps 1 to 4 and 8 to 10 in the previous procedure. In this case, the unit will need to be reconfigured using the complete start-up procedure.

11. APPENDIX

A.1 System configurations available

The system configurations available are shown in the table:

System configurations:

Configuration number	Description	Suction lines	Condenser lines	Compressors L1/L2	Maximum number of compressors per line L1/L2	Units present in pLAN (in addition to the terminal)	Reference diagram
1	No suction line, one condenser line	0	1	-	-	1	a
2	No suction line, two condenser lines	0	2	-	-	1	a
3	1 suction line (scroll or piston compressors), no condenser line	1	0	scroll, piston	12	1	a
4	1 suction line (scroll or piston compressors), 1 condenser line	1	1	scroll, piston	12	1	a
5	1 suction line (scroll or piston compressors), 1 condenser line on a separate board	1	1	scroll, piston	12	1, 3	b
6	2 suction lines on the same board (scroll or piston compressors), no condenser line	2	0	scroll, piston/ scroll, piston	12/12	1	c
7	2 suction lines on the same board (scroll or piston compressors), 1 condenser line	2	1	scroll, piston/ scroll, piston	12/12	1	c
8	2 suction lines on the same board (scroll or piston compressors), 1 condenser line on a separate board	2	1	scroll, piston/ scroll, piston	12/12	1, 3	e
9	2 suction lines (scroll or piston compressors), 2 condenser lines on the same board	2	2	scroll, piston/ scroll, piston	12/12	1	f
10	2 suction lines on the same board (scroll or piston compressors), 2 condenser lines on separate boards	2	2	scroll, piston/ scroll, piston	12/12	1, 3	g
11	2 suction lines on separate boards (scroll or piston compressors), 1 condenser line on suction line 1 board	2	1	scroll, piston/ scroll, piston	12/12	1, 2	h
12	2 suction lines on separate boards (scroll or piston compressors), 1 condenser line on a separate board	2	1	scroll, piston/ scroll, piston	12/12	1, 2, 3	d
13	2 suction lines on separate boards (scroll or piston compressors), 2 condenser lines (one for each suction line board)	2	2	scroll, piston/ scroll, piston	12/12	1, 2	h
14	2 suction lines on separate boards (scroll or piston compressors), 2 condenser lines on separate boards	2	2	scroll, piston/ scroll, piston	12/12	1, 2, 3, 4	i
15	1 suction line (up to 2 screw compressors), no condenser line	1	0	screw	2	1	a
16	1 suction line (up to 2 screw compressors), 1 condenser line	1	1	screw	2	1	a
17	1 suction line (up to 2 screw compressors), 1 condenser line on a separate board	1	1	screw	2	1, 3	b
18	2 suction lines on separate boards (up to 2 screw compressors on line 1 and scroll or piston compressors on line 2), 1 condenser line on suction line 1 board	2	1	screw/scroll, piston	2/12	1, 2	h
19	2 suction lines on separate boards (up to 2 screw compressors on line 1 and scroll or piston compressors on line 2), 1 condenser line on a separate board	2	1	screw/scroll, piston	2/12	1, 2, 3	d
20	2 suction lines on separate boards (up to 2 screw compressors on line 1 and scroll or piston compressors on line 2), 2 condenser lines (one for each suction line board)	2	2	screw/scroll, piston	2/12	1, 2	h
21	2 suction lines on separate boards (up to 2 screw compressors on line 1 and scroll or piston compressors on line 2), 2 condenser lines on separate boards	2	2	screw/scroll, piston	2/12	1, 2, 3, 4	i
22	2 suction lines on separate boards (scroll or piston compressors), 2 condenser lines (line 1 on separate board, line 2 on board in common with suction)	2	2	scroll, piston/ scroll, piston	2/12	1, 2, 3, 4	l

Tab. A.a

The system configurations available refer to the following diagrams:

- a. up to 1 suction line (scroll or piston compressors) and up to 1 condenser line on just one pRack pR300 board:

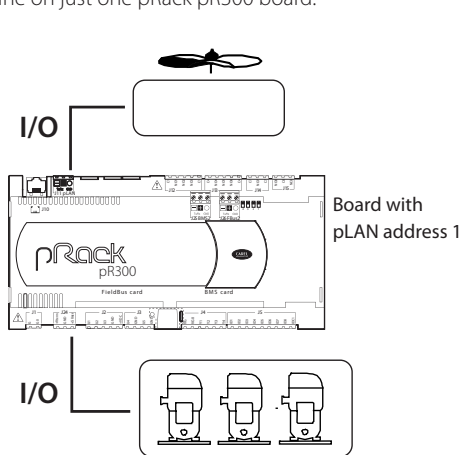

Fig. A.a

- b. 1 suction line (scroll or piston compressors) and 1 condenser line on a separate board:

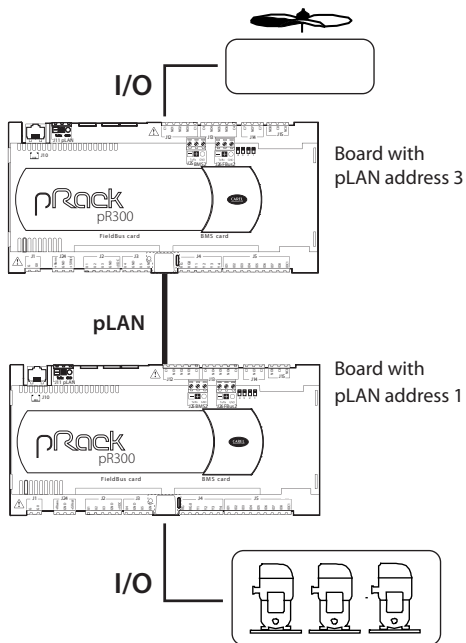

Fig. A.b

- c. 2 suction lines on the same board (scroll or piston compressors), 1 condenser line:

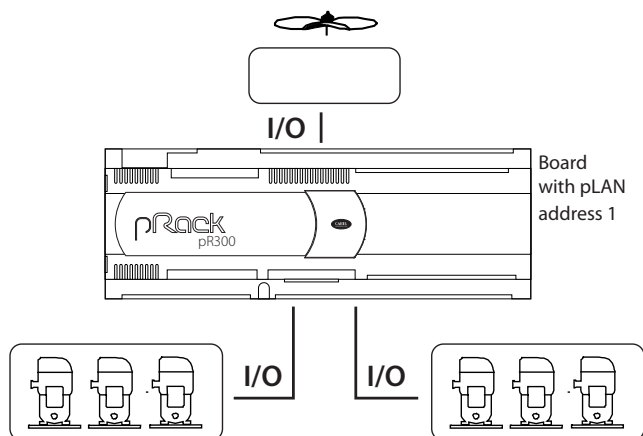

Fig. A.c

- d. 2 suction lines on separate boards (up to 2 screw compressors on line 1 and scroll or piston compressors on line 2), 1 condenser line on a separate board:

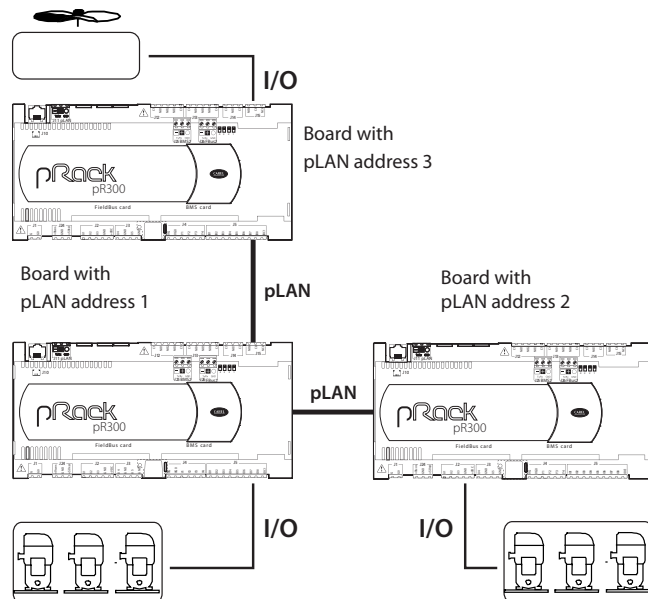

Fig. A.d

- e. 2 suction lines on the same board (scroll or piston compressors), 1 condenser line on a separate board:

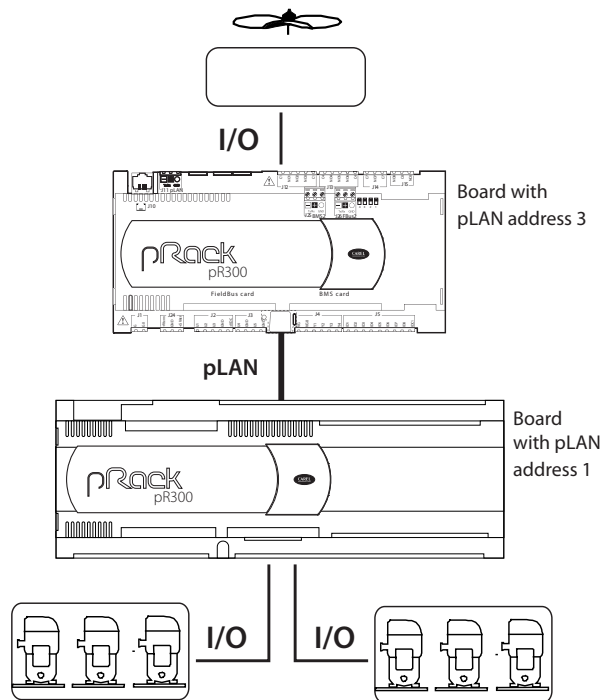

Fig. A.e

- f. 2 suction lines (scroll or piston compressors), 2 condenser lines on the same board:

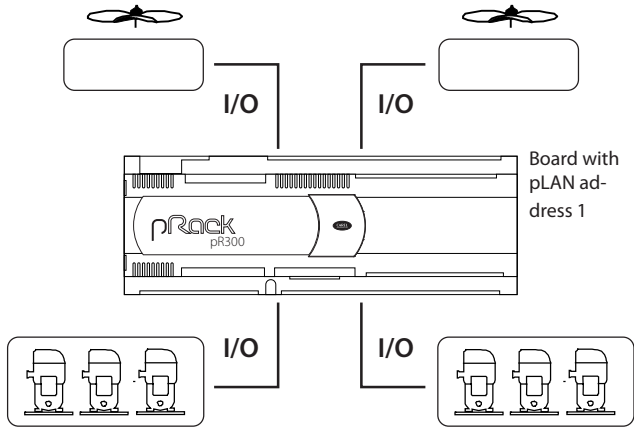

Fig. A.f

- g. 2 suction lines on the same board (scroll or piston compressors), 2 condenser lines on separate boards:

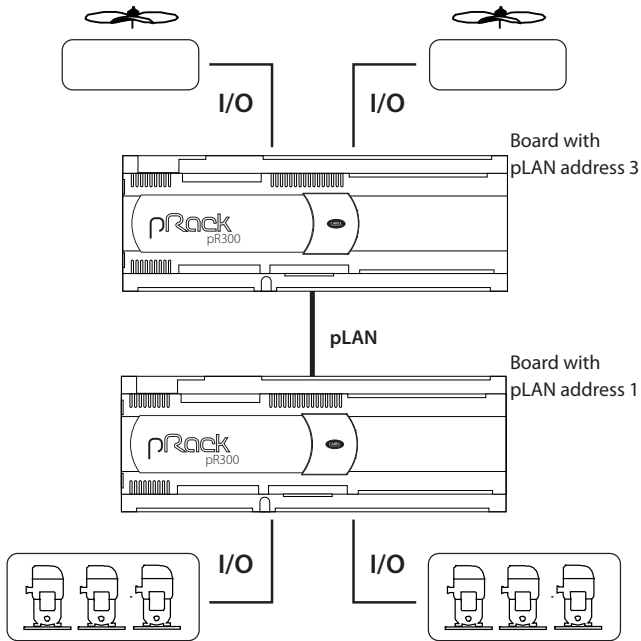

Fig. A.g

- h. 2 suction lines on separate boards (scroll or piston compressors), 2 condenser lines (one for each suction line board)

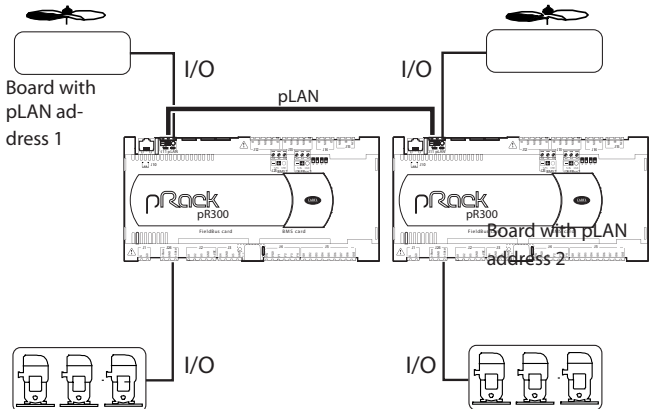

Fig. A.h

- i. 2 suction lines on separate boards (scroll or piston compressors), 2 condenser lines on separate boards

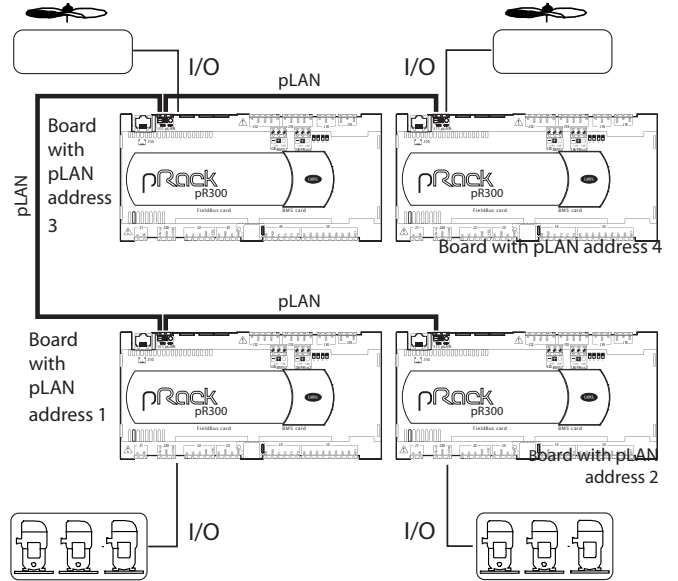

Fig. A.i

- j. 2 suction lines on separate boards (scroll or piston compressors), 2 condenser lines (line 1 on separate board, line 2 on common board with suction)

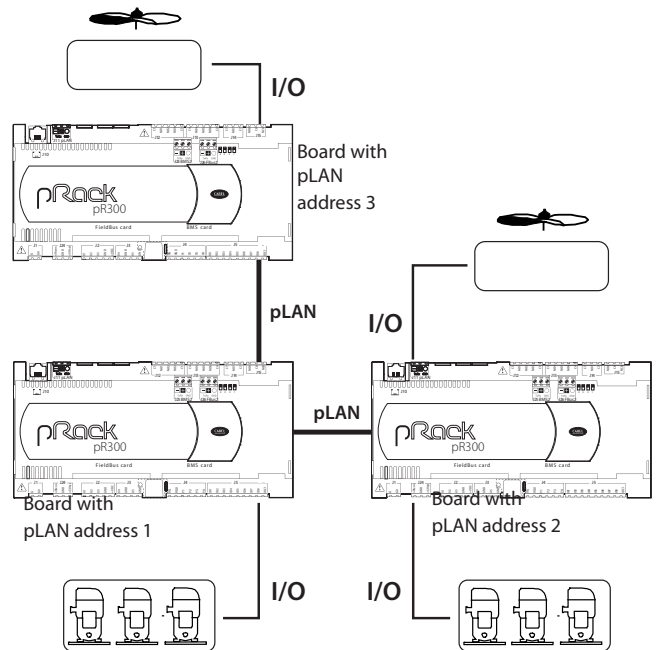

Fig. A.j

A.2 Special configurations for subcritical CO₂ systems, cascade and pumped systems

A.2.1 Cascade

The crucial aspect of this type of system is the cascade heat exchanger, normally a plate heat exchanger, which controls the condensing stage of the CO₂ system. At times there are two heat exchangers, so as to improve control at low loads and increase safety, and these are normally controlled by EXV electronic expansion valves with stepper motors. In these applications, as well as traditional control based on suction superheat, there is also integration with the low temperature rack, directly when the rack controller has a built-in driver, or via serial communication for external EVD EVO drivers. Given the nature of the refrigerant, condensed liquid CO₂ needs to be monitored in order to ensure good performance and protection. Up to 2 heat exchangers can be connected via Fieldbus to the pRack controller, with a driver for each heat exchanger. The drivers are connected to the board that manages the low temperature suction line. Up to 6 control steps can be configured for connecting other drivers controlled via digital input for superheat control. There can be maximum two plate heat exchangers used to condense CO₂, and the expansion valve is managed using the built-in driver on pRack pR300 or external EVD EVO driver suitably integrated into the system (Fieldbus communication over RS485).

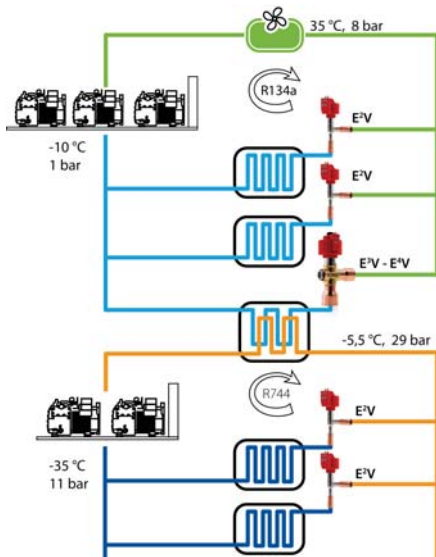

Fig. A.k

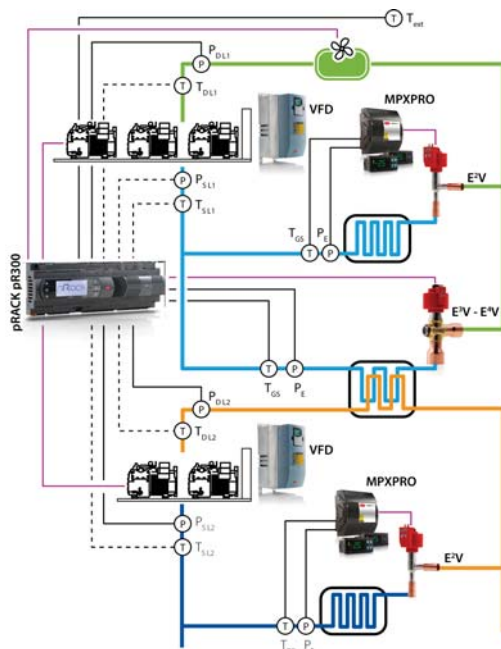

Fig. A.l

Legenda:

ac.	Description	Probe type	Notes
Text	Outside temperature	NTC - HP	
PD _{L1}	Discharge pressure line 1 (medium temperature)	4-20 mA 0-18.2 barg	
TD _{L1}	Discharge temperature line 1 (medium temperature)	NTC - HF	To control discharge temperature (opt.)
PS _{L1}	Suction pressure line 1 (medium temperature)	4-20 mA 0-7 barg	Can be used as backup for PE
TS _{L1}	Suction temperature line 1 (medium temperature)	NTC - HF	To control suction superheat (opt.)
P _E	Heat exchanger evaporation pressure	Ratiometric -1-9.3 barg	
T _{GS}	Heat exchanger superheated gas temperature	NTC - HF	
PD _{L2}	Discharge pressure line 2 (low temperature)	4-20 mA 0-44.8 barg	
TD _{L2}	Discharge temperature line 2 (low temperature)	NTC - HF	To control discharge temperature (opt.)
PS _{L2}	Suction pressure line 2 (low temperature)	4-20 mA 0-44.8 barg	
TS _{L2}	Suction temperature line 2 (low temperature)	NTC - HF	To control suction superheat (opt.)

Tab. 11.b

The exchange of information between compressor rack and heat exchanger allows traditional superheat control to be augmented by factors that are vital for this type of system, such as variation in low temperature compressor rack cooling capacity and the trend in CO₂ condensing pressure. (pRack only sends the control parameters and the cooling capacity to vary). The drivers connected via serial have advantages over external configurations (via digital inputs) as the parameters are easier to set (the driver screens can be accessed directly from the pRack controller) and are more responsive when unit cooling capacity changes considerably due to peaks in demand. The drivers connected via serial can use an estimated percentage of cooling capacity delivered by the circuit to influence normal superheat control.

When the variation in capacity exceeds 10% or when control commences, the driver pre-positions the valve to get closer to the optimum opening. This operation ensures good control of condensing pressure on the low temperature rack (S3 or A, configurable) when compressor on line 2 start. If the compressors on the low temperature rack are controlled by inverter, capacity modulation will be much more linear and anticipation of valve movements will have less influence (in terms of pre-positioning). If using one or more single drivers, the condensing pressure probe can be connected directly to the EVD EVO driver (S3), allowing just one pressure probe to be used for condenser control and for the EVD EVO driver safety procedure, which tends to open the valve when the CO₂ condensing pressure is too high. In this case, the CO₂ condensing pressure probe connected to pRack is optional.

This function can be used with the following configurations:

- pRack pR300 with built-in driver and just one heat exchanger
- pRack pR300 with single external EVD EVO driver
- pRack pR300 with 2 single external EVD EVO drivers
- pRack pR300 with 2 EVD EVO drivers, one of which built-in (only 1 exchanger) and 1 single external.

Note: if serial communication between driver and pRack is interrupted, the condensing pressure probe on the pRack, connected to the driver, will be disconnected and the safety procedures featured on pRack will be activated (alarm signal, use of the backup probe if configured, fan operation overridden to a preset value). One DRIVER is needed for each valve; if a Twin Driver is used, this will be managed as a single driver. The connection should be done on the first valve too (EXV1- J27 if a built-in driver is used).

Details of the pRack configuration Wizard

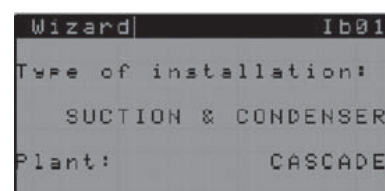

After having selected this type of configuration, the software takes a few seconds to pre-configure some settings relating to a typical cascade system, i.e. the second condenser line; the Wizard will prompt whether to

control the CO₂ condenser using the fans or the new EVS system:

```

Wizard| Ib1f
_2-Condensers config.
Condensing by: EUS
Valves number: 01
EUS ENABLE: YES
ADDRESS: 198
    
```

```

Wizard| Ib19
_2-Condensers config.
Communication Ok
between PCO and EVD
    
```

Note: carefully check the pressure control settings; for general uniformity of the software, automatic set point selection is not featured for the different types of control and different types of refrigerant. For example, the suggested default set point for the low temperature compressors is 3.5 bars; in a cascade system (subcritical CO₂) with R744 natural refrigerant, the reference pressure values are around 11 bars. Together with the set point, the probe limits and probe alarm thresholds will be correctly configured.

- Cascade, 2 suction lines, 2 condenser lines (external driver for managing the heat exchanger on the second line), single board;

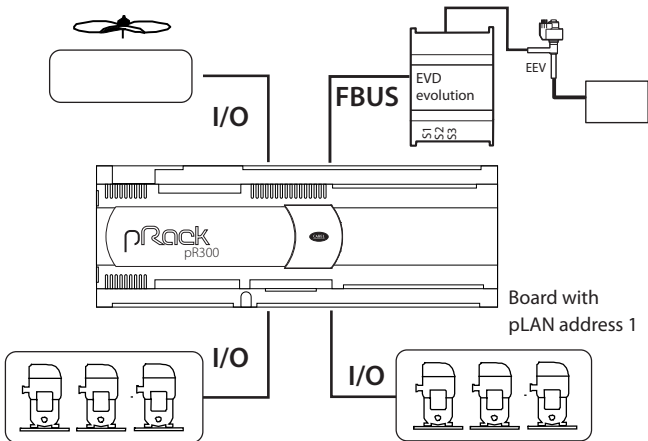

Fig. A.m

- Cascade, 2 suction lines, 2 condenser lines (built-in driver for managing the heat exchanger on the second line), single board;

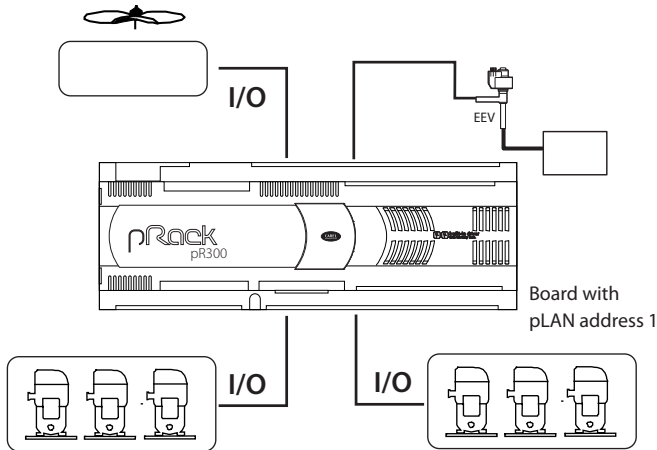

Fig. A.n

- Cascade, 2 suction lines, 2 condenser lines (built-in driver for managing the heat exchanger on the second line), double board;

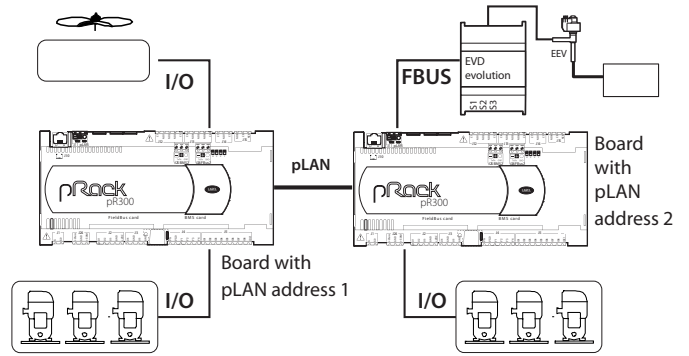

Fig. A.o

- Cascade, 2 suction lines, 2 condenser lines (external driver for managing the heat exchanger on the second line), double board;

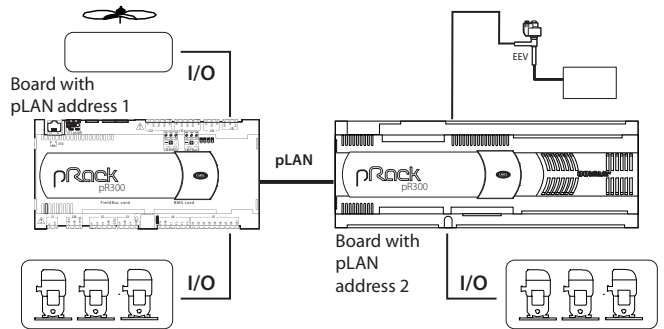

Fig. A.p

A2.2 Pumped

Less used than traditional cascade subcritical systems, this solution limits the use of HFC refrigerants to the equipment rooms. The medium temperature units are supplied with pumped liquid CO₂, while the low temperature units are fitted with expansion valves. The CO₂ is cooled by a dedicated chiller (NH₃ or r134a) inside a tank, normally with a tube bundle evaporator. In addition to traditional systems, these also include management of the pumps that deliver the liquid CO₂ to the medium temperature evaporators, where it does not expand but rather is only superheated and returns to the receiver in a semi-liquid state.

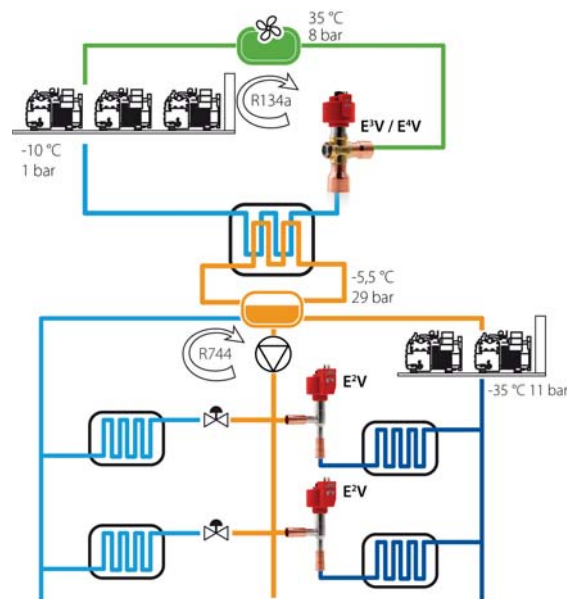

Fig. A.q

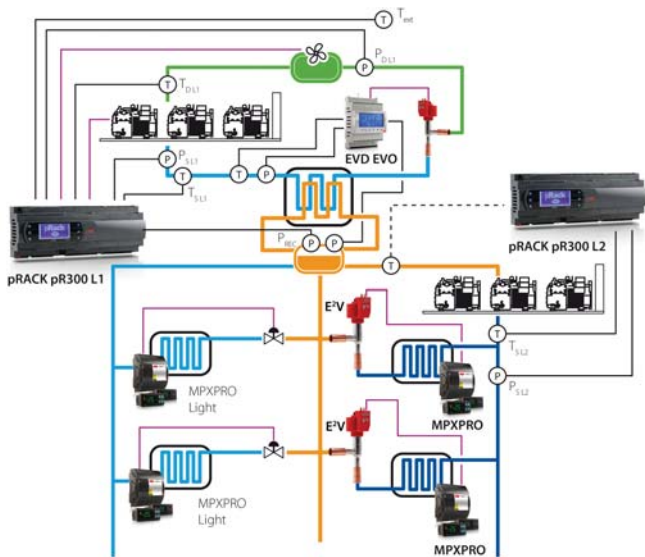

Fig. A.r

pRack pR300 L1 connections

ac.	Description	Probe type	Notes
T _{ext}	Outside temperature	NTC - HP	
PD _{L1}	Condensing pressure line 1 (medium temperature)	4-20 mA 0-18.2barg	
TD _{L1}	Discharge temperature line 1 (medium temperature)	NTC - HF	To control discharge temperature
PS _{L1}	Suction pressure line 1 (medium temperature)	4-20 mA 0-10barg	To control low pressure alarm
TS _{L1}	Suction temperature line 1 (medium temperature)	NTC - HF	To control suction superheat
P _{REC}	CO2 receiver pressure	4-20 mA 0-10barg	To control medium temperature compressors

Tab. 11.b

pRack pR300T L2 connections

ac.	Description	Probe type	Notes
TD _{L2}	Discharge temperature line 2 (low temperature)	NTC - HF	To control discharge temperature (opt.)
PS _{L2}	Suction pressure line 2 (low temperature)	4-20 mA 0-44.8barg	
TS _{L2}	Suction temperature line 2 (low temperature)	NTC - HF	To control suction superheat

Tab. 11.c

EVD EVO connections

ac.	Description	Probe type
P _{REC}	Discharge pressure line 2 (low temperature)	4-20 mA 0-44.8barg
P _E	Heat exchanger evaporation pressure	Ratiometric -1-9.3barg
T _{GS}	Heat exchanger superheated gas temperature	NTC - HF

Tab. 11.d

Dettagli Wizard della configurazione pRack

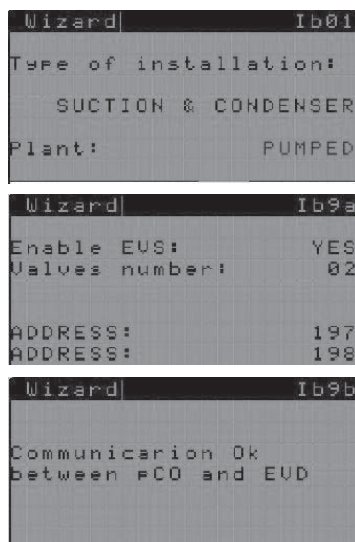

In this type of system, it is important to coordinate operation of the medium temperature rack with tube bundle evaporator control, to prevent low pressure problems. Pressure control inside the receiver is the main task; given the quantity of refrigerant contained and consequently its significant inertia, it is essential to activate the compressors based on the receiver pressure, and medium temperature rack suction pressure will only be monitored for safety, to prevent low pressure problems.

Medium temperature circuit control

Medium temperature circuit control uses a pressure sensor installed on the low temperature receiver; in order to exploit this sensor, pRack needs to use an auxiliary control function available under COMPRESSORS→LINE 1→CONTROL, in screen Cab20

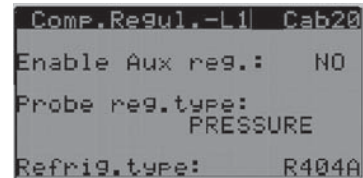

Fig. 11.t

This screen is used to enable the function, set the required type of control and the refrigerant in the auxiliary circuit.

An "auxiliary" control probe needs to be configured under INPUTS/OUTPUTS→STATUS→ANALOG INPUTS in a free position on the controller. The high and low auxiliary pressure/temperature probe alarms need to be set under COMPRESSORS→LINE 1→ALARMS, checking the control parameters.

EVD EVO and EXV drivers

Management of the tube bundle evaporator is critical in these types of applications, and the size of the evaporator, inertia of the load and proximity to the compressors require very fine control, which needs to adapt rapidly when the compressors are started or stopped, respond gradually to changes of load, not flood the compressors, and protect against low suction pressure alarms.

Functions on the EVD EVO driver, such as low superheat, low suction temperature, low suction pressure and high CO₂ condensing pressure protection, therefore need to be correctly calibrated based on system features (number and type of compressors, size of the evaporator and the receiver, whether there are receivers on the suction line, system dynamics). All these settings are found under OTHER FUNCTIONS→EVS on the board that manages suction line 1.

Note: One DRIVER is needed for each valve; if a Twin Driver is used, this will be managed as a single driver. The connection should be done on the first valve too (EXV1- J27 if a built-in driver is used).

- Pumped, 2 suction lines (external driver for managing the heat exchanger on the first line), 1 condenser line, single board;

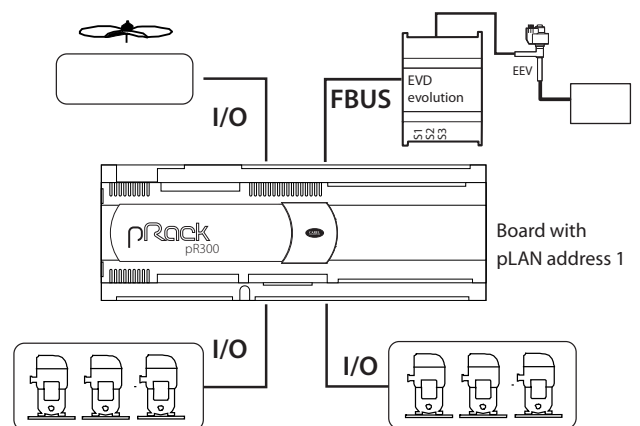

Fig. A.s

- Pumped, 2 suction lines (built-in driver for managing the heat exchanger on the first line), 1 condenser line, single board;

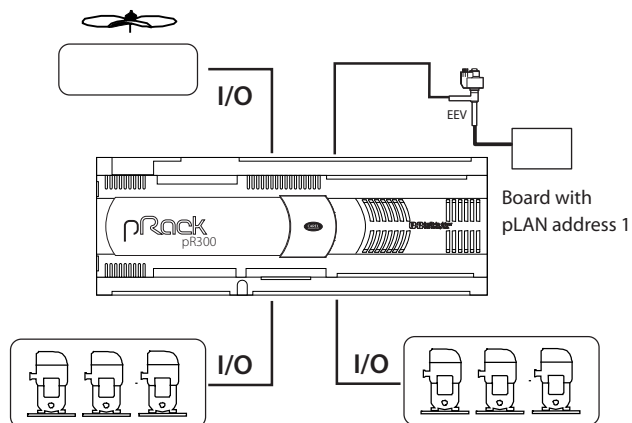

Fig. A.t

- Pumped, 2 suction lines (external driver for managing the heat exchanger on the first line), 1 condenser line, double board

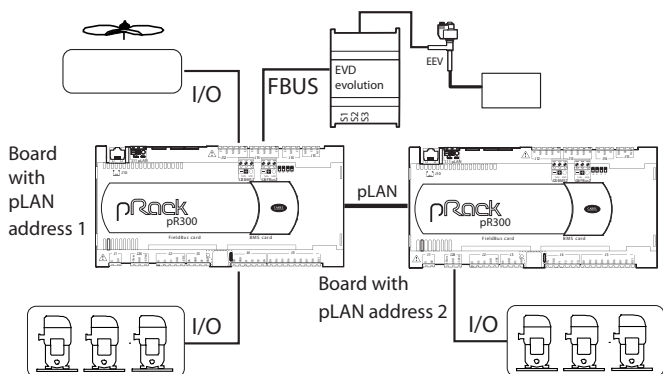

Fig. A.u

- Pumped, 2 suction lines (built-in driver for managing the heat exchanger on the first line), 1 condenser line, double board

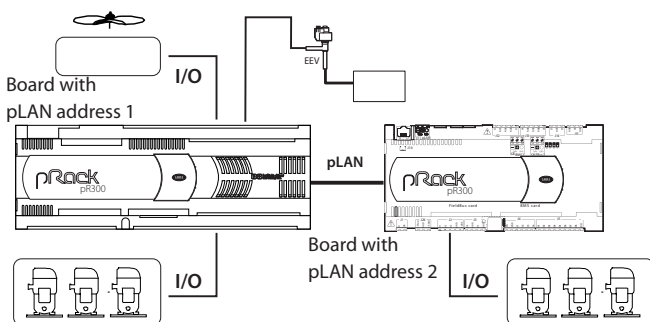

Fig. A.v

Note: don't configure the second condensing line.

A.3 System configurations with more than one pLAN board

If the system configuration involves the connection of more than one board in a pLAN, the addresses must be set correct before select a solution of configuration.

For the addresses to be assigned to the pRack pR300 boards see Appendix A.1.

pRack pR300 can use two user terminals (as well as a built-in terminal) with addresses 31 and 32. The default user terminal address is 32, so only if a second terminal is required must the address of this be set to 31, as described below. The address of the terminal is also required when having to set the address of the pRack pR300 boards, when multiple boards are connected to the pLAN.

After having correctly connected and configured the pLAN network of pRack pR300 boards, the system can be configured as described in paragraph 4.1.

A.3.1 Setting the address of the terminal

The pRack pR300 user terminal is supplied with the default address 32, allowing the terminal to be used without requiring any additional operations; nonetheless, in order to use an additional terminal or configure the pLAN address of the boards, it needs to be changed according to the following procedure:

1. power the terminal via the special telephone connector;
2. press the 3 buttons, **↑**, **↓** and **←** together for at least 5 seconds; the terminal will display a screen similar to the one below, with the cursor flashing in the top left corner:

```
Display address
setting.....:32
I/O Board address:01
```

3. press **←** once: the cursor will move to the "Display address setting" field;
4. select the desired value using **↑** and **↓**, and confirm by pressing **←** again; if the value selected is different from the value saved, the following screen will be displayed and the new value will be saved to the display's permanent memory.

```
Display address
changed
```

Note: if the address field is set to 0, the "I/O Board address" field is no longer displayed, as it has no meaning..

Important

- if the settings are not made correctly, the text and the images on the display will be displayed incorrectly and out of order.
- if during this operation the terminal detects inactivity of the pRack board whose output is being displayed, the display is cleared and a message similar to the one below is shown.

```
Display address
changed
```

If the terminal detects inactivity of the entire pLAN network, that is, it does not receive any messages from the network for 10 seconds consecutively, it clears the display and shows the following message:

```
NO LINK
```

A.3.2 Setting the address of the pRack pR300 board

The pLAN address of the pRack boards can be set from any pGD1 terminal, using the following procedure:

1. set address 0 on the terminal (see the previous paragraph for details on how to set this address);
2. power down the pRack pR300 board;
3. disconnect any pLAN connections to other boards from the pRack pR300 board;
4. connect the terminal to the pRack pR300 board;
5. power up the pRack pR300 board, while pressing the **↑** and **🔔** buttons on the terminal together. After a few seconds the pRack pR300 board begins the start-up sequence and the display shows a screen similar to the one below:

```
#####
Selftest
Please wait
#####
```

6. when this screen is displayed, wait 10 seconds and then release the buttons;
7. the pRack pR300 board interrupts the start-up sequence and shows a configuration screen, similar to the one below:

```
PLAN address: 0
UP: increase
DOWN: decrease
ENTER: save & exit
```

Then set the pLAN address using the **↑** and **↓** buttons on the terminal.
8. Confirm the address by pressing **↵**: the pRack pR300 board completes the start-up sequence and uses the set address.

A3.3 Example of configuring a system with 2 suction and condenser lines using the Wizard

Below is a possible example of using the Wizard to configure a typical system like the one shown in the figure, with 2 suction lines and 2 condenser lines on different boards:

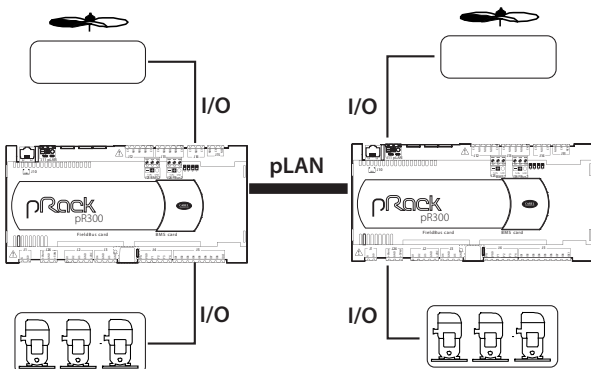

Fig. A.w

The preliminary operations to be completed before configuration are as follows:

1. with the boards not connected in the pLAN, power up the second pRack board and set the pLAN address to 2 (for details see Appendix A.2)
2. power down and connect the two boards in the pLAN, plus any terminals, as described in paragraph 3.7
3. power up the boards and wait for the Wizard selection screen to be displayed

Then select the type of system as SUCTION & CONDENSER:

```
Wizard Ib01
TYPE OF Installation:
SUCTION & CONDENSER
```

Set the type of compressors and control for suction line 1, answering the questions prompted by the pRack pR300 software, e.g.:

```
Wizard Ib03
COMPRESSOR CONFIG.
COMPRESSOR TYPE:
RECIPROCATING
COMPRESSOR NUMBER: 3
```

```
Wizard Ib40
COMPRESSOR CONFIG.
REGULATION BY:
PRESSURE
MEASURE UNIT: BAR3
REFRIGERANT: R404A
```

```
Wizard Ib41
COMPRESSOR CONFIG.
REGULATION TYPE:
PROPORTIONAL BAND
Enable integral time
action: YES
```

After having configured suction line 1, a prompt will be shown to configure another suction line, obviously the answer is YES:

```
Wizard Ib43
COMPRESSOR CONFIG.
Configure another
suction line:
YES
```

To the next question, which prompts if there is a pRack board dedicated to the second line, answer YES; in this way, the pRack pR300 software prepares to configure the board with address 2 in the pLAN:

```
Wizard Ib45
COMPRESSOR CONFIG.
Dedicated PRACK
board for
suction line:
YES
```

After having answered the questions for the configuration of the second suction line, the software then asks if there is a pLAN board dedicated to condenser line 1. In the case shown in the example, answer NO.

```

Wizard                               Ib90
Compressor config.

Dedicated PRack
board for
condensing line:                       NO

```

After having configured condenser line 1, the software asks if condenser line 2 is used; answer YES:

```

Wizard                               Ib96
Configure another
condensing line:                       YES

```

After having configured the second condenser line, the software offers the option to automatically configure the I/Os (choosing YES), as described in par. 4.1.4. If choosing NO, each individual I/O needs to be configured manually at the end of the wizard. In addition, the software asks the user whether or not to display a summary of the settings made:

```

Wizard                               Ib23
Enable I/O config: YES
Visualize Wizard
report?                                NO
(PUSH [DOWN]
to continue)

```

If the settings are correct, the set values can be installed:

```

Wizard                               Ib33
Boards necessary
  1  _ _ _ _
  |
  2  _ _ _ _
All boards Present,
(ENTER) to continue

```

After waiting a few seconds, the unit can be started.

```

Wizard
Successfully Complete

Press (ENTER) to
continue

```

Note: after having configured pRack pR300, the device needs to be switched off and on again to permanently save the new data.

A.4 Alarm table

Code	Description	Reset	Delay	Alarm relay	Action
ALA01	Discharge temperature probe malfunction	Automatic	60s	R2	Related functions disabled
ALA02	Condensing pressure probe malfunction	Automatic	60s	R1	Related functions disabled
ALA03	Outside temperature probe malfunction	Automatic	60s	R2	Related functions disabled
ALA04	Generic probe malfunction A, PLB1	Automatic	60s	R2	Related functions disabled
ALA05	Generic probe malfunction B, PLB1	Automatic	60s	R2	Related functions disabled
ALA06	Generic probe malfunction C, PLB1	Automatic	60s	R2	Related functions disabled
ALA07	Generic probe malfunction D, PLB1	Automatic	60s	R2	Related functions disabled
ALA08	Generic probe malfunction E, PLB1	Automatic	60s	R2	Related functions disabled
ALA09	Generic probe malfunction A, PLB2	Automatic	60s	R2	Related functions disabled
ALA10	Generic probe malfunction B, PLB2	Automatic	60s	R2	Related functions disabled
ALA11	Generic probe malfunction C, PLB2	Automatic	60s	R2	Related functions disabled
ALA12	Generic probe malfunction D, PLB2	Automatic	60s	R2	Related functions disabled
ALA13	Generic probe malfunction E, PLB2	Automatic	60s	R2	Related functions disabled
ALA14	Generic probe malfunction A, PLB3	Automatic	60s	R2	Related functions disabled
ALA15	Generic probe malfunction B, PLB3	Automatic	60s	R2	Related functions disabled
ALA16	Generic probe malfunction C, PLB3	Automatic	60s	R2	Related functions disabled
ALA17	Generic probe malfunction D, PLB3	Automatic	60s	R2	Related functions disabled
ALA18	Generic probe malfunction E, PLB3	Automatic	60s	R2	Related functions disabled
ALA19	Generic probe malfunction A, PLB4	Automatic	60s	R2	Related functions disabled
ALA20	Generic probe malfunction B, PLB4	Automatic	60s	R2	Related functions disabled
ALA21	Generic probe malfunction C, PLB4	Automatic	60s	R2	Related functions disabled
ALA22	Generic probe malfunction D, PLB4	Automatic	60s	R2	Related functions disabled
ALA23	Generic probe malfunction E, PLB4	Automatic	60s	R2	Related functions disabled
ALA24	Suction pressure probe malfunction	Automatic	60s	R1	Related functions disabled
ALA25	Suction temperature probe malfunction	Automatic	60s	R2	Related functions disabled
ALA26	Room temperature probe malfunction	Automatic	60s	R2	Related functions disabled
ALA27	Condensing pressure probe malfunction, line 2	Automatic	60s	R1	Related functions disabled
ALA28	Discharge temperature probe malfunction, line 2	Automatic	60s	R2	Related functions disabled
ALA29	Suction pressure probe malfunction, line 2	Automatic	60s	R1	Related functions disabled
ALA30	Suction temperature probe malfunction, line 2	Automatic	60s	R2	Related functions disabled
ALA31	Condensing pressure backup probe malfunction	Automatic	60s	R2	Related functions disabled
ALA32	Condensing pressure backup probe malfunction, line 2	Automatic	60s	R2	Related functions disabled
ALA33	Suction pressure backup probe malfunction	Automatic	60s	R2	Related functions disabled
ALA34	Suction pressure backup probe malfunction, line 2	Automatic	60s	R2	Related functions disabled
ALA35	Common oil temperature probe malfunction	Automatic	60s	R2	Related functions disabled
ALA36	Common oil temperature probe malfunction, line 2	Automatic	60s	R2	Related functions disabled
ALA39	Discharge temperature probe malfunction, compressors 1 to 6	Automatic	60s	R2	Related functions disabled
ALA40	Discharge temperature probe malfunction, compressors 1 to 6, line 2	Automatic	60s	R2	Related functions disabled
ALA41	Oil temperature probe malfunction compressors 1 to 6, line 1	Automatic	60s	R2	Related functions disabled
ALA42	Oil temperature probe malfunction compressors 1, line 2	Automatic	60s	R2	Related functions disabled
ALB01	Low suction pressure from pressure switch	Semiautomatic	Settable	R1	Shutdown compressor
ALB02	High condensing pressure from pressure switch	Manual/automatic	Settable	R1	Shutdown compressor
ALB03	Low condensing pressure from probe	Automatic	Settable	R1	Force fans to 0%
ALB04	High condensing pressure from probe	Automatic	Settable	R1	Force fans to 100% and compressor stop
ALB05	Liquid level	Automatic	Settable	R2	-
ALB06	Common oil differential	Automatic	Settable	R2	-
ALB07	Common fan circuit breaker	Automatic	Settable	Settable	-
ALB08	Low suction pressure from pressure switch, line 2	Semiautomatic	Settable	R1	Shutdown compressors, line 2
ALB09	High condensing pressure from pressure switch, line 2	Manual/automatic	Settable	R1	Shutdown compressors, line 2
ALB10	Low condensing pressure from probe, line 2	Automatic	Settable	R1	Force fans to 0%, line 2
ALB11	High condensing pressure from probe, line 2	Automatic	Settable	R1	Force fans to 100% and stop compressor, line 2
ALB12	Liquid level, line 2	Automatic	Settable	R2	-
ALB13	Common oil differential, line 2	Automatic	Settable	R2	-
ALB14	Common fan circuit breaker, line 2	Automatic	Settable	Settable	-
ALB15	High suction pressure from probe	Automatic	Settable	R1	-
ALB16	Low suction pressure from probe	Automatic	Settable	R1	-
ALB17	High suction pressure from probe, line 2	Automatic	Settable	R1	-
ALB18	Low suction pressure from probe, line 2	Automatic	Settable	R1	-
ALB21	Shutdown to prevent high pressure	Manual	Settable	R1	Shutdown compressor
ALB22	Shutdown to prevent high pressure, line 2	Manual	Settable	R1	Shutdown compressors, line 2
ALC01	Alarm 1, compressor 1	Manual/automatic	Settable	Settable	Shutdown compressor 1
ALC02	Alarm 2, compressor 1	Manual/automatic	Settable	Settable	Shutdown compressor 1
ALC03	Alarm 3, compressor 1	Manual/automatic	Settable	Settable	Shutdown compressor 1
ALC04	Alarm 4, compressor 1	Manual/automatic	Settable	Settable	Shutdown compressor 1
ALC05	Alarm 5, compressor 1	Manual/automatic	Settable	Settable	Shutdown compressor 1
ALC06	Alarm 6, compressor 1	Manual/automatic	Settable	Settable	Shutdown compressor 1
ALC07	Alarm 7, compressor 1	Manual/automatic	Settable	Settable	Shutdown compressor 1
ALC08	Alarm 1, compressor 2	Manual/automatic	Settable	Settable	Shutdown compressor 2
ALC09	Alarm 2, compressor 2	Manual/automatic	Settable	Settable	Shutdown compressor 2
ALC10	Alarm 3, compressor 2	Manual/automatic	Settable	Settable	Shutdown compressor 2
ALC11	Alarm 4, compressor 2	Manual/automatic	Settable	Settable	Shutdown compressor 2
ALC12	Alarm 5, compressor 2	Manual/automatic	Settable	Settable	Shutdown compressor 2
ALC13	Alarm 6, compressor 2	Manual/automatic	Settable	Settable	Shutdown compressor 2
ALC14	Alarm 7, compressor 2	Manual/automatic	Settable	Settable	Shutdown compressor 2
ALC15	Alarm 1, compressor 3	Manual/automatic	Settable	Settable	Shutdown compressor 3
ALC16	Alarm 2, compressor 3	Manual/automatic	Settable	Settable	Shutdown compressor 3
ALC17	Alarm 3, compressor 3	Manual/automatic	Settable	Settable	Shutdown compressor 3
ALC18	Alarm 4, compressor 3	Manual/automatic	Settable	Settable	Shutdown compressor 3
ALC19	Alarm 5, compressor 3	Manual/automatic	Settable	Settable	Shutdown compressor 3
ALC20	Alarm 6, compressor 3	Manual/automatic	Settable	Settable	Shutdown compressor 3
ALC21	Alarm 7, compressor 3	Manual/automatic	Settable	Settable	Shutdown compressor 3
ALC22	Alarm 1, compressor 4	Manual/automatic	Settable	Settable	Shutdown compressor 4
ALC23	Alarm 2, compressor 4	Manual/automatic	Settable	Settable	Shutdown compressor 4
ALC24	Alarm 3, compressor 4	Manual/automatic	Settable	Settable	Shutdown compressor 4
ALC25	Alarm 4, compressor 4	Manual/automatic	Settable	Settable	Shutdown compressor 4
ALC26	Alarm 5, compressor 4	Manual/automatic	Settable	Settable	Shutdown compressor 4
ALC27	Alarm 6, compressor 4	Manual/automatic	Settable	Settable	Shutdown compressor 4
ALC28	Alarm 7, compressor 4	Manual/automatic	Settable	Settable	Shutdown compressor 5
ALC29	Alarm 1, compressor 5	Manual/automatic	Settable	Settable	Shutdown compressor 5

Code	Description	Reset	Delay	Alarm relay	Action
ALG15	Generic low temperature alarms 1 to 5, PLB1	Manual/automatic	Settable	Settable	-
ALG16	Generic low temperature alarms 1 to 5, PLB2	Manual/automatic	Settable	Settable	-
ALG17	Generic low temperature alarms 1 to 5, PLB3	Manual/automatic	Settable	Settable	-
ALG18	Generic low temperature alarms 1 to 5, PLB4	Manual/automatic	Settable	Settable	-
ALG19	Generic high modulation alarms 6 and 7, PLB1	Manual/automatic	Settable	Settable	-
ALG20	Generic high modulation alarms 6 and 7, PLB2	Manual/automatic	Settable	Settable	-
ALG21	Generic high modulation alarms 6 and 7, PLB3	Manual/automatic	Settable	Settable	-
ALG22	Generic high modulation alarms 6 and 7, PLB4	Manual/automatic	Settable	Settable	-
ALG23	Generic low modulation alarms 6 and 7, PLB1	Manual/automatic	Settable	Settable	-
ALG24	Generic low modulation alarms 6 and 7, PLB2	Manual/automatic	Settable	Settable	-
ALG25	Generic low modulation alarms 6 and 7, PLB3	Manual/automatic	Settable	Settable	-
ALG26	Generic low modulation alarms 6 and 7, PLB4	Manual/automatic	Settable	Settable	-
ALG27	Normal alarm generic functions 8/9, PLB1	Manual/automatic	Settable	Settable	-
ALG28	Serious alarm generic functions 8/9, PLB1	Manual/automatic	Settable	Settable	-
ALG29	Normal alarm generic functions 8/9, PLB2	Manual/automatic	Settable	Settable	-
ALG30	Serious alarm generic functions 8/9, PLB2	Manual/automatic	Settable	Settable	-
ALG31	Normal alarm generic functions 8/9, PLB3	Manual/automatic	Settable	Settable	-
ALG32	Serious alarm generic functions 8/9, PLB3	Manual/automatic	Settable	Settable	-
ALG33	Normal alarm generic functions 8/9, PLB4	Manual/automatic	Settable	Settable	-
ALG34	Serious alarm generic functions 8/9, PLB4	Manual/automatic	Settable	Settable	-
ALH01	ChillBooster fault	Automatic	Settable	R2	Disable ChillBooster
ALH02	ChillBooster fault, line 2	Automatic	Settable	R2	Disable ChillBooster
ALO02	pLAN malfunction	Automatic	60s	R1	Shutdown unit
ALT01	Compressor maintenance request	Manual	-	Not featured	-
ALT02	Compressor maintenance request, line 2	Manual	-	Not featured	-
ALT03	ChillBooster maintenance request	manual	0s	Not featured	-
ALT04	ChillBooster maintenance request, line 2	manual	0s	Not featured	-
ALU01	Configuration not allowed	Automatic	Not featured	Not featured	Shutdown unit
ALU02	Control probes missing	Automatic	Not featured	Not featured	Shutdown unit
ALW01	High pressure prevent warning	Automatic	Settable	Not featured	Shutdown compressor, except minimum load stage
ALW02	High pressure prevent warning, line 2	Automatic	Settable	Not featured	Shutdown compressor line 2, except minimum load stage
ALW03	Compressor inverter warning	Automatic	Not featured	Not featured	-
ALW04	Compressor inverter warning, line 2	Automatic	Not featured	Not featured	-
ALW05	Fan inverter warning	Automatic	Not featured	Not featured	-
ALW06	Fan inverter warning, line 2	Automatic	Not featured	Not featured	-
ALW07	Envelope warning: refrigerant not compatible with compressor series	Automatic	Not featured	Not featured	-
ALW08	Envelope warning: custom envelope not configured	Automatic	Not featured	Not featured	-
ALW09	Envelope warning: suction or condensing probes not configured	Automatic	Not featured	Not featured	-
ALW10	Low superheat warning	Automatic	Not featured	Not featured	-
ALW11	Low superheat warning, line 2	Automatic	Not featured	Not featured	-
ALW12	Warning, ChillBooster operating without outside sensor	Automatic	0s	Not featured	-
ALW13	Warning, ChillBooster operating without outside sensor, line 2	Automatic	0s	Not featured	-
ALE01	EEV motor error on Driver 1	Automatic	Config.	Config.	-
ALE01	High condensing temperature on Driver 1	Automatic	Config.	Config.	-
ALE01	Low suction temperature on Driver 1	Automatic	Config.	Config.	-
ALE02	Low superheat on Driver 1	Automatic	Config.	Config.	-
ALE02	Low operating pressure on Driver 1	Automatic	Config.	Config.	-
ALE02	Maximum operating pressure on Driver 2	Automatic	Config.	Config.	-
ALE03	EEV motor error on Driver 2	Automatic	Config.	Config.	-
ALE03	High condensing temperature on Driver 2	Automatic	Config.	Config.	-
ALE03	Low suction temperature on Driver 2	Automatic	Config.	Config.	-
ALE04	Low superheat on Driver 2	Automatic	Config.	Config.	-
ALE04	Low operating pressure on Driver 2	Automatic	Config.	Config.	-
ALE04	Maximum operating pressure on Driver 2	Automatic	Config.	Config.	-
ALE05	EEPROM error on Driver 1 in PLB1	Automatic	Config.	Config.	-
ALE05	Probe S1 error on Driver 1 in PLB1	Automatic	Config.	Config.	-
ALE05	Probe S2 error on Driver 1 in PLB1	Automatic	Config.	Config.	-
ALE05	Probe S3 error on Driver 1 in PLB1	Automatic	Config.	Config.	-
ALE05	Probe S4 error on Driver 1 in PLB1	Automatic	Config.	Config.	-
ALE05	Offline error on Driver 1 in PLB1	Automatic	Config.	Config.	-
ALE05	Battery error on Driver 1 in PLB1	Automatic	Config.	Config.	-
ALE07	EEPROM error on Driver 1 in PLB3	Automatic	Config.	Config.	-
ALE07	Probe S1 error on Driver 1 in PLB3	Automatic	Config.	Config.	-
ALE07	Probe S2 error on Driver 1 in PLB3	Automatic	Config.	Config.	-
ALE07	Probe S3 error on Driver 1 in PLB3	Automatic	Config.	Config.	-
ALE07	Probe S4 error on Driver 1 in PLB3	Automatic	Config.	Config.	-
ALE07	Offline error on Driver 1 in PLB3	Automatic	Config.	Config.	-
ALE07	Battery error on Driver 1 in PLB3	Automatic	Config.	Config.	-
ALE08	EEPROM error on Driver 2 in PLB1	Automatic	Config.	Config.	-
ALE08	Probe S1 error on Driver 2 in PLB1	Automatic	Config.	Config.	-
ALE08	Probe S2 error on Driver 2 in PLB1	Automatic	Config.	Config.	-
ALE08	Probe S3 error on Driver 2 in PLB1	Automatic	Config.	Config.	-
ALE08	Probe S4 error on Driver 2 in PLB1	Automatic	Config.	Config.	-
ALE08	Offline error on Driver 2 in PLB1	Automatic	Config.	Config.	-
ALE08	Battery error on Driver 2 in PLB1	Automatic	Config.	Config.	-
ALE10	EEPROM error on Driver 2 in PLB3	Automatic	Config.	Config.	-
ALE10	Probe S1 error on Driver 2 in PLB3	Automatic	Config.	Config.	-
ALE10	Probe S2 error on Driver 2 in PLB3	Automatic	Config.	Config.	-
ALE10	Probe S3 error on Driver 2 in PLB3	Automatic	Config.	Config.	-
ALE10	Probe S4 error on Driver 2 in PLB3	Automatic	Config.	Config.	-
ALE10	Offline error on Driver 2 in PLB3	Automatic	Config.	Config.	-
ALE10	Battery error on Driver 2 in PLB3	Automatic	Config.	Config.	-
ALE11	Parameter transmission error on Driver 1	Automatic	0	Config.	-
ALE12	Parameter transmission error on Driver 2	Automatic	0	Config.	-
ALE13	FW compatibility error on Driver 1	Automatic	0	Config.	-
ALE14	FW compatibility error on Driver 2	Automatic	0	Config.	-

Tab. A.e

A.5 I/O Table

Digital inputs

	Mask Index	Description	Chan.	Logic	Notes	
Line 1	Ac05, Baack	Unit ON/OFF line 1				
	Baa56, Caaah	Common low pressure switch line 1				
	Baada, Caa14	Compressor inverter warning				
	Baa02, Caa01	Alarm 1 compressor 1 line 1				
	Baa03, Caa02	Alarm 2 compressor 1 line 1				
	Baa04, Caa03	Alarm 3 compressor 1 line 1				
	Baa05, Caa04	Alarm 4 compressor 1 line 1				
	Baa06, Caa05	Alarm 5 compressor 1 line 1				
	Baa07, Caa06	Alarm 6 compressor 1 line 1				
	Baa08, Caa07	Alarm 7 compressor 1 line 1				
	Baa09, Caa15	Alarm 1 compressor 2 line 1				
	Baa10, Caa16	Alarm 2 compressor 2 line 1				
	Baa11, Caa17	Alarm 3 compressor 2 line 1				
	Baa12, Caa18	Alarm 4 compressor 2 line 1				
	Baa13, Caa19	Alarm 5 compressor 2 line 1				
	Baa14, Caa20	Alarm 6 compressor 2 line 1				
	Baa15, Caa21	Alarm 7 compressor 2 line 1				
	Baa17, Caa28	Alarm 1 compressor 3 line 1				
	Baa18, Caa29	Alarm 2 compressor 3 line 1				
	Baa19, Caa30	Alarm 3 compressor 3 line 1				
	Baa20, Caa31	Alarm 4 compressor 3 line 1				
	Baa21, Caa32	Alarm 5 compressor 3 line 1				
	Baa22, Caa33	Alarm 6 compressor 3 line 1				
	Baa23, Caa34	Alarm 7 compressor 3 line 1				
	Baa24, Caa40	Alarm 1 compressor 4 line 1				
	Baa25, Caa41	Alarm 2 compressor 4 line 1				
	Baa26, Caa42	Alarm 3 compressor 4 line 1				
	Baa27, Caa43	Alarm 4 compressor 4 line 1				
	Baa28, Caa44	Alarm 5 compressor 4 line 1				
	Baa29, Caa45	Alarm 6 compressor 4 line 1				
	Baa30, Caa46	Alarm 7 compressor 4 line 1				
	Baa32, Caa53	Alarm 1 compressor 5 line 1				
	Baa33, Caa54	Alarm 2 compressor 5 line 1				
	Baa34, Caa55	Alarm 3 compressor 5 line 1				
	Baa35, Caa56	Alarm 4 compressor 5 line 1				
	Baa36, Caa57	Alarm 5 compressor 5 line 1				
	Baa37, Caa58	Alarm 6 compressor 5 line 1				
	Baa38, Caa59	Alarm 7 compressor 5 line 1				
	Baa39, Caa65	Alarm 1 compressor 6 line 1				
	Baa40, Caa66	Alarm 2 compressor 6 line 1				
	Baa41, Caa67	Alarm 3 compressor 6 line 1				
	Baa42, Caa68	Alarm 4 compressor 6 line 1				
	Baa43, Caa69	Alarm 5 compressor 6 line 1				
	Baa44, Caa70	Alarm 6 compressor 6 line 1				
	Baa45, Caa71	Alarm 7 compressor 6 line 1				
	Baa47, Caa78	Alarm 1 compressor 7 line 1				
	Baa48, Caa79	Alarm 2 compressor 7 line 1				
	Baa49, Caa84	Alarm 1 compressor 8 line 1				
	Baa50, Caa85	Alarm 2 compressor 8 line 1				
	Baa51, Caa90	Alarm 1 compressor 9 line 1				
	Baa52, Caa91	Alarm 2 compressor 9 line 1				
	Baa53, Caa95	Alarm 1 compressor 10 line 1				
	Baa54, Caa99	Alarm 1 compressor 11 line 1				
	Baa55, Caaad	Alarm 1 compressor 12 line 1				
	Baa58, Caaaj	Common oil alarm line 1				
	Baa59, Caaak	Liquid level alarm line 1				
	Condenser	Baadc	Fan inverter warning line 1			
		Baa57	Common high pressure switch line 1			
		Baaau, Daa01	Fan overload 1 line 1			
Baaav, Daa02		Fan overload 2 line 1				
Baaaw, Daa03		Fan overload 3 line 1				
Baaax, Daa04		Fan overload 4 line 1				
Baaay, Daa05		Fan overload 5 line 1				
Baaaz, Daa06		Fan overload 6 line 1				
Baaba, Daa07		Fan overload 7 line 1				
Baabbb, Daa08		Fan overload 8 line 1				
Baabbc, Daa09		Fan overload 9 line 1				
Baabbd, Daa10		Fan overload 10 line 1				
Baabbe, Daa11		Fan overload 11 line 1				
Baabbf, Daa12		Fan overload 12 line 1				
Baabbg, Daa13		Fan overload 13 line 1				
Baabbh, Daa14		Fan overload 14 line 1				
Baabbi, Daa15		Fan overload 15 line 1				
Baabbj, Daa16		Fan overload 16 line 1				
Baabk, Daa17	Common fan overload line 1					
Other functions	Baabl	Heat recovery line 1				
	Baacx, Ega01	ChillBooster fault line 1				
	Baacz	Enable floating condensing line 1				
	Baaccl, Caa00, Daa41	Set point compensation line 1				
	Daa43	Anti noise line 1				
	Daa44	Split condenser line 1				
Daa45	Enable floating condensing line 1					
Eea02	Heat recovery activation line 1					

	Mask Index	Description	Chan.	Logic	Notes		
Line 2	Suction	Ac08, Baacy			Unit ON/OFF line 2		
		Baaap, Cbaah			Common low pressure switch line 2		
		Baadb, Cba14			Compressor inverter warning line 2		
		Baaar, Cbaaj			Common oil alarm line 2		
		Baa61, Cba01			Alarm 1 compressor 1 line 2		
		Baa62, Cba02			Alarm 2 compressor 1 line 2		
		Baa63, Cba03			Alarm 3 compressor 1 line 2		
		Baa64, Cba04			Alarm 4 compressor 1 line 2		
		Baa65, Cba05			Alarm 5 compressor 1 line 2		
		Baa66, Cba06			Alarm 6 compressor 1 line 2		
		Baa67, Cba07			Alarm 7 compressor 1 line 2		
		Baa68, Cba15			Alarm 1 compressor 2 line 2		
		Baa69, Cba16			Alarm 2 compressor 2 line 2		
		Baa70, Cba17			Alarm 3 compressor 2 line 2		
		Baa71, Cba18			Alarm 4 compressor 2 line 2		
		Baa72, Cba19			Alarm 5 compressor 2 line 2		
		Baa73, Cba20			Alarm 6 compressor 2 line 2		
		Baa74, Cba21			Alarm 7 compressor 2 line 2		
		Baa76, Cba28			Alarm 1 compressor 3 line 2		
		Baa77, Cba29			Alarm 2 compressor 3 line 2		
		Baa78, Cba30			Alarm 3 compressor 3 line 2		
		Baa79, Cba31			Alarm 4 compressor 3 line 2		
		Baa80, Cba32			Alarm 5 compressor 3 line 2		
		Baa81, Cba33			Alarm 6 compressor 3 line 2		
		Baa82, Cba34			Alarm 7 compressor 3 line 2		
		Baa83, Cba40			Alarm 1 compressor 4 line 2		
		Baa84, Cba41			Alarm 2 compressor 4 line 2		
		Baa85, Cba42			Alarm 3 compressor 4 line 2		
		Baa86, Cba43			Alarm 4 compressor 4 line 2		
		Baa87, Cba44			Alarm 5 compressor 4 line 2		
		Baa88, Cba45			Alarm 6 compressor 4 line 2		
		Baa89, Cba46			Alarm 7 compressor 4 line 2		
		Baa91, Cba53			Alarm 1 compressor 3 line 2		
		Baa92, Cba54			Alarm 2 compressor 3 line 2		
		Baa93, Cba55			Alarm 3 compressor 3 line 2		
		Baa94, Cba56			Alarm 4 compressor 3 line 2		
		Baa95, Cba57			Alarm 5 compressor 3 line 2		
		Baa96, Cba58			Alarm 6 compressor 3 line 2		
		Baa97, Cba59			Alarm 7 compressor 3 line 2		
		Baa98, Cba65			Alarm 1 compressor 4 line 2		
		Baa99, cba66			Alarm 2 compressor 4 line 2		
		Baaaa, Cba67			Alarm 3 compressor 4 line 2		
		Baaab, Cba68			Alarm 4 compressor 4 line 2		
		Baaac, Cba69			Alarm 5 compressor 4 line 2		
		Baaad, Cba70			Alarm 6 compressor 4 line 2		
		Baaae, Cba71			Alarm 7 compressor 4 line 2		
		Baaag, Cba78			Alarm 1 compressor 7 line 2		
		Baaah, Cba79			Alarm 2 compressor 7 line 2		
		Baaai, Cba84			Alarm 1 compressor 8 line 2		
		Baaaj, Cba85			Alarm 2 compressor 8 line 2		
		Baaak, Cba90			Alarm 1 compressor 9 line 2		
		Baaal, Cba91			Alarm 2 compressor 9 line 2		
		Baaam, Cba95			Alarm 1 compressor 10 line 2		
		Baaan, Cba99			Alarm 1 compressor 11 line 2		
		Baaao, Cbaad			Alarm 1 compressor 12 line 2		
		Baaas, Cbaak			Liquid level alarm line 2		
		Line 2	Condenser	Baadd			Fan inverter warning line 2
				Baaaq			Common high pressure switch line 2
				Baabn, Dba01			Fan overload 1 line 2
Baabo, Dba02					Fan overload 2 line 2		
Baabp, Dba03					Fan overload 3 line 2		
Baabq, Dba04					Fan overload 4 line 2		
Baabr, Dba05					Fan overload 5 line 2		
Baabs, Dba06					Fan overload 6 line 2		
Baabt, Dba07					Fan overload 7 line 2		
Baabu, Dba08					Fan overload 8 line 2		
Baabv, Dba09					Fan overload 9 line 2		
Baabw, Dba10					Fan overload 10 line 2		
Baabx, Dba11					Fan overload 11 line 2		
Baaby, Dba12					Fan overload 12 line 2		
Babzb, Dba13					Fan overload 13 line 2		
Baaca, Dba14					Fan overload 14 line 2		
Baacb, Dba15					Fan overload 15 line 2		
Baac, Dba16			Fan overload 16 line 2				
Baacd, Dba17			Common fan overload line 2				
Line 2	Other functions	Baace			Heat recovery line 2		
		Eqba01			ChillBooster fault line 2		
		Baade			Enable floating condensing line 2		
		Baacm, Cbd06, Dbd08			Set point compensation line 2		
		Dba43			Anti noise line 2		
		Dba44			Split condenser line 2		
		Dba45			Enable floating condensing line 2		
Eeba02			Heat recovery activation line 2				
Comuni		Baacf, Efe16			Generic DI F		
		Baacg, Efe17			Generic DI G		
		Baach, Efe18			Generic DI H		
		Baaci, Efe19			Generic DI I		
		Baacj, Efe20			Generic DI J		
Baacn			pRack automatic or manual operation				
Baadf			pLoads digital input 1				
Baadg			pLoads digital input 2				

Tab. A.f

Digital outputs

	Mask Index	Description	Chan.	Logic	Notes	
Line 1	Suction	Bac02, Caa08				
			Line relay compressor 1 line 1			
			Partwinding/Star relay compressor 1 line 1			
			Delta relay compressor 1 line 1			
		Bac03, Caa09	Valve 1 compressor 1 line 1			
		Bac04, Caa10	Valve 2 compressor 1 line 1			
		Bac05, Caa11	Valve 3 compressor 1 line 1			
		Bac07, Caa12	Balancing valve compressor 1 line 1			
		Bac08, Caa22	Line relay compressor 2 line 1			
			Partwinding/Star relay compressor 2 line 1			
			Delta relay compressor 2 line 1			
		Bac10, Caa23	Valve 1 compressor 2 line 1			
		Bac11, Caa24	Valve 2 compressor 1 line 1			
		Bac12, Caa25	Valve 3 compressor 1 line 1			
		Bac13, Caa26	Balancing valve compressor 1 line 1			
		Bac15, Caa35	Line relay compressor 3 line 1			
			Partwinding/Star relay compressor 3 line 1			
			Delta relay compressor 3 line 1			
		Bac16, Caa36	Valve 1 compressor 3 line 1			
		Bac17, Caa37	Valve 2 compressor 3 line 1			
		Bac18, Caa38	Valve 3 compressor 3 line 1			
		Bac20, Caa39	Balancing valve compressor 3 line 1			
		Bac21, Caa47	Line relay compressor 4 line 1			
			Partwinding/Star relay compressor 4 line 1			
			Delta relay compressor 4 line 1			
		Bac22, Caa48	Valve 1 compressor 4 line 1			
		Bac23, Caa49	Valve 2 compressor 4 line 1			
		Bac24, Caa50	Valve 3 compressor 4 line 1			
		Bac26, Caa51	Balancing valve compressor 4 line 1			
		Bac28, Caa60	Line relay compressor 5 line 1			
			Partwinding/Star relay compressor 5 line 1			
			Delta relay compressor 5 line 1			
		Bac29, Caa61	Valve 1 compressor 5 line 1			
		Bac30, Caa62	Valve 2 compressor 5 line 1			
		Bac31, Caa63	Valve 3 compressor 5 line 1			
		Bac33, Caa64	Balancing valve compressor 5 line 1			
		Bac34, Caa72	Line relay, compressor 6 line 1			
			Partwinding/Star relay, compressor 6 line 1			
			Delta relay, compressor 6 line 1			
		Bac35, Caa73	Valve 1, compressor 6 line 1			
		Bac36, Caa74	Valve 2, compressor 6 line 1			
		Bac37, Caa75	Valve 3, compressor 6 line 1			
		Bac39, Caa76	Balancing valve, compressor 6 line 1			
		Bac41, Caa80	Line relay compressor 7 line 1			
			Partwinding/Star relay compressor 7 line 1			
			Delta relay compressor 7 line 1			
		Bac42, Caa81	Valve 1 compressor 7 line 1			
		Bac43, Caa82	Valve 2 compressor 7 line 1			
		Bac45, Caa83	Balancing valve compressor 7 line 1			
		Bac46, Caa86	Line relay compressor 8 line 1			
			Partwinding/Star relay compressor 8 line 1			
			Delta relay compressor 8 line 1			
		Bac47, Caa87	Valve 1 compressor 8 line 1			
		Bac48, Caa88	Valve 2 compressor 8 line 1			
		Bac50, Caa89	Balancing valve compressor 8 line 1			
		Bac51, Caa92	Line relay compressor 9 line 1			
			Partwinding/Star relay compressor 9 line 1			
			Delta relay compressor 9 line 1			
		Bac52, Caa93	Valve 1 compressor 9 line 1			
		Bac55, Caa94	Balancing valve compressor 9 line 1			
		Bac56, Caa96	Line relay compressor 10 line 1			
			Partwinding/Star relay compressor 10 line 1			
			Delta relay compressor 10 line 1			
		Bac57, Caa97	Valve 1 compressor 10 line 1			
		Bac60, Caa98	Balancing valve compressor 10 line 1			
		Bac61, Caaaa	Relay line compressor 11 line 1			
			Partwinding/Star relay compressor 11 line 1			
			Delta relay compressor 11 line 1			
		Bac62, Caaab	Valve 1 compressor 11 line 1			
		Bac65, Caaac	Balancing valve compressor 11 line 1			
		Bac66, Caaae	Relay line compressor 12 line 1			
			Partwinding/Star relay compressor 12 line 1			
	Delta relay compressor 12 line 1					
Bac67, Caaaf	Valve 1 compressor 12 line 1					
Bac70, Caaag	Balancing valve compressor 12 line 1					
Ebaa01	Subcooling valve line 1					
Line 1	Condenser	Bacbt, Daa21	Fan 1 line 1			
		Bacbu, Daa22	Fan 2 line 1			
		Bacbv, Daa23	Fan 3 line 1			
		Bacbw, Daa24	Fan 4 line 1			
		Bacbx, Daa25	Fan 5 line 1			
		Bacby, Daa26	Fan 6 line 1			
		Bacbz, Daa27	Fan 7 line 1			
		Bacca, Daa28	Fan 8 line 1			
		Baccb, Daa29	Fan 9 line 1			
		Bacc, Daa30	Fan 10 line 1			
		Baccd, Daa31	Fan 11 line 1			
		Bacce, Daa32	Fan 12 line 1			
		Baccf, Daa33	Fan 13 line 1			
		Baccg, Daa34	Fan 14 line 1			
		Bacc, Daa35	Fan 15 line 1			
		Bacci, Daa36	Fan 16 line 1			

	Mask Index	Description	Chan.	Logic	Notes
Line 1	Other functions	Bacck, Eaaa03	Heat recovery pump line 1		
		Baccl, Eaaa02	ChillBooster line 1		
		Bacdp, Eaaa11	Oil pump 1 line 1		
		Bacdq, Eaaa12	Oil pump 2 line 1		
		Bacdr, Eaaa13	Oil fan line 1		
		Bacdv, Ecaa07, Eaaa07	Liquid injection valve/Economizer compressor 1 line 1		
		Bacdw, Ecaa08, Eaaa08	Liquid injection valve/Economizer compressor 2 line 1		
		Bacdx, Ecaa09, Eaaa09	Liquid injection valve/Economizer compressor 3 line 1		
		Bacdy, Ecaa10, Eaaa10	Liquid injection valve/Economizer compressor 4 line 1		
		Bacdz, Ecaa11, Eaaa11	Liquid injection valve/Economizer compressor 5 line 1		
		Bacea, Ecaa12, Eaaa12	Liquid injection valve/ Economizer, compressor 6 line 1		
		Bac01	Anti liquid return line 1		
		Bacei	Force from BMS line 1		
		Bacek, Ebaa01	Subcooling line 1		
		Eaaa15	Oil cooling pump screw compressor 1 line 1		
		Eaaa16	Oil cooling fan screw compressor 1 line 1		
		Eaaa18	Oil cooling pump screw compressor 2 line 1		
		Eaaa19	Oil cooling fan screw compressor 2 line 1		
		Eaaa40	Oil level valve compressor 1 line 1		
		Eaaa41	Oil level valve compressor 2 line 1		
		Eaaa42	Oil level valve compressor 3 line 1		
		Eaaa43	Oil level valve compressor 4 line 1		
		Eaaa44	Oil level valve compressor 5 line 1		
		Eaaa45	Oil level valve, compressor 6 line 1		
		Line 2	Suction	Bac73, Cba08	Relay line compressor 1 line 2 Partwinding/Star relay compressor 1 line 2 Delta relay compressor 1 line 2
Bac74, Cba09	Valve 1 compressor 1 line 2				
Bac75, Cba10	Valve 2 compressor 1 line 2				
Bac76, Cba11	Valve 3 compressor 1 line 2				
Bac78, Cba12	Balancing valve compressor 1 line 2				
Bac79, Cba22	Line relay compressor 2 line 2 Partwinding/Star relay compressor 2 line 2 Delta relay compressor 2 line 2				
Bac80, Cba23	Valve 1 compressor 2 line 2				
Bac81, Cba24	Valve 2 compressor 1 line 2				
Bac82, Cba25	Valve 3 compressor 1 line 2				
Bac84, Cba26	Balancing valve compressor 1 line 2				
Bac86, Cba35	Line relay compressor 3 line 2 Partwinding/Star relay compressor 3 line 2 Delta relay compressor 3 line 2				
Bac87, Cba36	Valve 1 compressor 3 line 2				
Bac88, Cba37	Valve 2 compressor 3 line 2				
Bac89, Cba38	Valve 3 compressor 3 line 2				
Bac91, Cba39	Balancing valve compressor 3 line 2				
Bac92, Cba47	Line relay compressor 4 line 2 Partwinding/Star relay compressor 4 line 2 Delta relay compressor 4 line 2				
Bac94, Cba48	Valve 1 compressor 4 line 2				
Bac95, Cba49	Valve 2 compressor 4 line 2				
Bac96, Cba50	Valve 3 compressor 4 line 2				
Bac98, Cba51	Balancing valve compressor 4 line 2				
Baca, Cba60	Line relay compressor 5 line 2 Partwinding/Star relay compressor 5 line 2 Delta relay compressor 5 line 2				
Bacab, Cba61	Valve 1 compressor 5 line 2				
Bacac, Cba62	Valve 2 compressor 5 line 2				
Bacad, Cba63	Valve 3 compressor 5 line 2				
Bacaf, Cba64	Balancing valve compressor 5 line 2				
Ebba01	Subcooling valve line 2				

	Mask Index	Description	Chan.	Logic	Notes	
Line 2	Suction	Bacag, Cba72				
		Line relay, compressor 6 line 2				
		Partwinding/Star relay, compressor 6 line 2				
		Delta relay, compressor 6 line 2				
		Bacah, Cba73	Valve 1 compressor 6 line 2			
		Bacai, Cba74	Valve 2 compressor 6 line 2			
		Bacaj, Cba75	Valve 3 compressor 6 line 2			
		Bacal, Cba76	Balancing valve, compressor 6 line 2			
		Bacan, Cba80	Line relay compressor 7 line 2			
		Partwinding/Star relay compressor 7 line 2				
		Delta relay compressor 7 line 2				
		Bacao, Cba81	Valve 1 compressor 7 line 2			
		Bacap, Cba82	Valve 2 compressor 7 line 2			
		Bacar, Cba83	Balancing valve compressor 7 line 2			
		Bacas, Cba86	Line relay compressor 8 line 2			
		Partwinding/Star relay compressor 8 line 2				
		Delta relay compressor 8 line 2				
		Bacat, Cba87	Valve 1 compressor 8 line 2			
		Bacau, Cba88	Valve 2 compressor 8 line 2			
		Bacaw, Cba89	Balancing valve compressor 8 line 2			
		Bacax, Cba92	Line relay compressor 9 line 2			
	Partwinding/Star relay compressor 9 line 2					
	Delta relay compressor 9 line 2					
	Bacay, Cba93	Valve 1 compressor 9 line 2				
	Bacbb, Cba94	Balancing valve compressor 9 line 2				
	Bacbc, Cba96	Line relay compressor 10 line 2				
	Partwinding/Star relay compressor 10 line 2					
	Delta relay compressor 10 line 2					
	Bacbd, Cba97	Valve 1 compressor 10 line 2				
	Bacbg, Cba98	Balancing valve compressor 10 line 2				
	Bacbh, Cbaaa	Line relay compressor 11 line 2				
	Partwinding/Star relay compressor 11 line 2					
	Delta relay compressor 11 line 2					
	Bacbi, Cbaab	Valve 1 compressor 11 line 2				
	Bacbl, Cbaac	Balancing valve compressor 11 line 2				
	Bacbm, Cbaae	Line relay compressor 12 line 2				
	Partwinding/Star relay compressor 12 line 2					
	Delta relay compressor 12 line 2					
	Bacbn, Cbaaf	Valve 1 compressor 12 line 2				
	Bacbg, Cbaag	Balancing valve compressor 12 line 2				
	Line 2	Condenser	Baccn, Dba20	Fan 1 line 2		
			Bacco, Dba21	Fan 2 line 2		
Baccp, Dba22			Fan 3 line 2			
Baccq, Dba23			Fan 4 line 2			
Baccr, Dba24			Fan 5 line 2			
Baccs, Dba25			Fan 6 line 2			
Bacct, Dba26			Fan 7 line 2			
Baccu, Dba27			Fan 8 line 2			
Baccv, Dba28			Fan 9 line 2			
Baccw, Dba29			Fan 10 line 2			
Baccx, Dba30			Fan 11 line 2			
Baccy, Dba31			Fan 12 line 2			
Baccz, Dba32			Fan 13 line 2			
Bacda, Dba33			Fan 14 line 2			
Bacdb, Dba34			Fan 15 line 2			
Bacdc, Dba35			Fan 16 line 2			
Bacdd, Dba36			Fan inverter line 2			
Other functions			Bacde, Eeba03	Heat recovery pump line 2		
		Bacdf, Egba02	ChillBooster line 2			
		Bacds, Eaba10	Oil pump 1 line 2			
		Bacdt, Eaba11	Oil pump 2 line 2			
		Bacdu, Eaba12	Oil fan line 2			
		Baceb, Ecba07, Edba07	Liquid injection valve compressor 1 line 2			
		Bacec, Ebca08, Edba08	Liquid injection valve compressor 2 line 2			
		Baced, Ecba09, Edba09	Liquid injection valve compressor 3 line 2			
		Bacee, Ecba10, Edba10	Liquid injection valve compressor 4 line 2			
		Bacef, Ecba11, Edba11	Liquid injection valve compressor 5 line 2			
		Baceg, Ecba12, Edba12	Liquid injection valve compressor 6 line 2			
		Bac72	Anti liquid return line 2			
		Bacej	Force from BMS line 2			
		Bacel, Ebbb01	Subcooling line 2			
		Eaba40	Oil level valve compressor 1 line 2			
		Eaba41	Oil level valve compressor 2 line 2			
		Eaba42	Oil level valve compressor 3 line 2			
		Eaba43	Oil level valve compressor 4 line 2			
Eaba44		Oil level valve compressor 5 line 2				
Eaba45	Oil level valve, compressor 6 line 2					
Common	Bacdg, Efe21	Generic stage function 1				
	Bacdh, Efe22	Generic stage function 2				
	Bacdi, Efe23	Generic stage function 3				
	Bacdj, Efe24	Generic stage function 4				
	Bacdk, Efe25	Generic stage function 5				
	Bacdl	Active alarms				
	Bacdm, Efe26	Generic alarm function 1				
	Bacdn, Efe27	Generic alarm function 2				
	Bacdo, Efe28	Generic scheduling function				
	Baceh	Sign of life				
	Bacem	Minor alarm				
	Bacen	Serious alarm				

Tab. A.g

Analogue inputs

	Mask Index	Description	Chan.	Logic	Notes		
Line 1	Suct.	Bab01, Caaal	Return pressure probe line 1				
		Bab02, Caaam	Return backup pressure probe line 1				
		Bab03, Caaao	Return temperature probe line 1				
	C.	Bab04, Daa39	Condensing pressure probe line 1				
		Bab09, Daa40	Backup condensing pressure probe line 1				
	Other functions	Bab11, Daa41	Discharge temperature probe line 1				
		Bab12	Liquid temperature probe line 1				
		Bab13, Eaaa05	Heat recovery outlet temperature probe line 1				
		Bab15, Daa20	Outside temperature probe line 1				
		Bab16	Room temperature probe line 1				
		Bab17, Eaaa04	Oil temperature probe line 1				
		Bab29, Ecaa01, Edaa01	Discharge temperature probe compressor 1 line 1				
		Bab30, Ecaa02, Edaa02	Discharge temperature probe compressor 2 line 1				
		Bab31, Ecaa03, Edaa03	Discharge temperature probe compressor 3 line 1				
		Bab32, Ecaa04, Edaa04	Discharge temperature probe compressor 4 line 1				
		Bab33, Ecaa05, Edaa05	Discharge temperature probe compressor 5 line 1				
		Bab34, Ecaa06, Edaa06	Discharge temperature probe, compressor 6 line 1				
		Bab41, Eaaa05	Oil temperature probe compressor 1 line 1				
		Bab42, Eaaa06	Oil temperature probe compressor 2 line 1				
		Bab43, Eaaa07	Oil temperature probe compressor 3 line 1				
		Bab44, Eaaa08	Oil temperature probe compressor 4 line 1				
		Bab45, Eaaa09	Oil temperature probe compressor 5 line 1				
		Bab46, Eaaa10	Oil temperature probe compressor 6 line 1				
		Line 2	Suct.	Bab05, Caal	Return pressure probe line 2		
				Bab06, Caaam	Return backup pressure probe line 2		
	Bab07, Caaao			Return temperature probe line 2			
	C.		Bab08, Dba39	Condensing pressure probe line 2			
			Bab10, Dba40	Backup condensing pressure probe line 2			
	Other		Bab48, Dba38	Discharge temperature probe line 2			
			Bab49	Liquid temperature probe line 2			
			Bab14, Eeba05	Heat recovery outlet temperature probe line 2			
			Bab18, Eaba04	Oil temperature probe line 2			
			Bab35, Ecba01, Edba01	Discharge temperature probe compressor 1 line 2			
			Bab36, Ecba02, Edba02	Discharge temperature probe compressor 2 line 2			
			Bab37, Ecba03, Edba03	Discharge temperature probe compressor 3 line 2			
			Bab38, Ecba04, Edba04	Discharge temperature probe compressor 4 line 2			
			Bab39, Ecba05, Edba05	Discharge temperature probe compressor 5 line 2			
			Bab40, Ecba06, Edba06	Discharge temperature probe, compressor 6 line 2			
			Bab47, Eaba05	Oil temperature probe compressor 1 line 2			
			Common	Bab19, Efe06	Generic active probe A		
				Bab20, Efe07	Generic passive probe A		
				Bab21, Efe08	Generic active probe B		
	Bab22, Efe09	Generic passive probe B					
	Bab23, Efe10	Generic active probe C					
	Bab24, Efe11	Generic passive probe C					
	Bab25, Efe12	Generic active probe D					
Bab26, Efe13	Generic passive probe D						
Bab27, Efe14	Generic active probe E						
Bab28, Efe15	Generic passive probe E						
Bab58	Energy meter						

Tab. A.h

Analogue outputs

	Mask Index	Description	Chan.	Logic	Notes
Line 1	Bad01, Caa14	Compressor inverter output line 1			
	Bad02, Eaaa14	Oil pump output line 1			
	Bad07, Daa38	Fan inverter output line 1			
	Bad08, Eaaa04	Heat recovery valve output line 1			
	Bad12, Efe29	Generic modulating output 1			
	Eaaa17	Oil cooling pump output screw compressor 1			
	Line 2	Bad04	Compressor inverter output line 2		
Bad05, Eaba13		Oil pump output line 2			
Bad10, Dba37		Fan inverter output line 2			
Bad11, Eeba04		Heat recovery valve output line 2			
Bad13, Efe30		Generic modulating output 2			
Eaaa20	Oil cooling pump output screw compressor 2				

Tab. A.i

CAREL reserves the right to modify or change its products without prior warning.

CAREL

CAREL INDUSTRIES - Headquarters
Via dell'Industria, 11 - 35020 Brugine - Padova (Italy)
Tel. (+39) 049.9716611 - Fax (+39) 049.9716600
e-mail: carel@carel.com - www.carel.com

Agenzia / Agency: