

N2024 / N20230 N3424 / N34230

DAMPER ACTUATORS 20/34 Nm (177/300 lb-in)
FOR FLOATING / 2-POSITION CONTROL

PRODUCT DATA

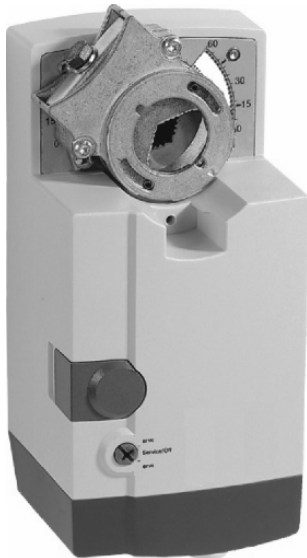

GENERAL

These direct-coupled damper actuators provide two-position and floating control for:

- air dampers,
- VAV units,
- air handlers,
- ventilation flaps,
- louvers, and
- reliable control for air damper applications with up to 4.6 m² / 50 sq.ft. (20 Nm / 177 lb-in) or 7.8 m² / 85 sq. ft. (34 Nm / 300 lb-in) (seal-less dampers; air friction-dependent).

FEATURES

- **New self-centering shaft adapter**
- **Access cover to facilitate connectivity**
- **Declutch for manual adjustment**
- **Mechanical end limits**
- **Field-installable auxiliary switches**
- **Rotation direction selectable by switch**
- **Mountable in any orientation (no IP54 if upside down)**
- **Mechanical position indicator**

SPECIFICATIONS

Supply voltage

N2024 / N3424	24 Vac ±15%, 50/60 Hz
N20230/N34230	230 Vac ±15%, 50/60 Hz

Nominal voltage

N2024 / N3424	24 Vac, 50/60 Hz
N20230/N34230	230 Vac, 50/60 Hz

All values stated hereinafter apply to operation under nominal voltage conditions.

Power consumption

N2024	6 VA / 6 W
N20230	8 VA / 8 W
N3424	9 VA / 9 W
N34230	13 VA / 10 W

Ambient limits

Ambient operating limits	-20...+60 °C (-5...+140 °F)
Ambient storage limits	-40...+80 °C (-40...+175 °F)
Relative humidity	5...95%, non-condensing

Safety

Protection standard	IP54 as per EN 60529
Protection class	II as per EN 60730-1
Overvoltage category	III

Lifetime

Full strokes	60000
Repositions	1.5 million

Mounting

Round damper shaft	10...27 mm (3/8...1-1/16")
Square damper shaft	10...18 mm (3/8...11/16"); 45° steps
Shaft length	min. 22 mm (7/8")

End switches (when included)

Rating	5 A (resistive) / 3 A (inductive)
Triggering points	5° / 85°

Torque rating

N2024 / N20230	20 Nm (177 lb-in)
N3424 / N34230	34 Nm (300 lb-in)

Runtime

	110 sec (50 Hz) / 95 sec (60 Hz)
--	----------------------------------

Rotation stroke

	95° ± 3°
--	----------

Dimensions

	see "Dimensions" on page 8
--	----------------------------

Weight (without cables)

	1.45 kg (3 lbs. 3 oz.)
--	------------------------

Noise rating

	40 dB(A) max. at 1 m
--	----------------------

MODELS

order number	supply voltage	end switches	feedback	power consumption	torque
N2024 / N2024-2POS	24 Vac	--	--	6 VA / 6 W	20 Nm (177 lb-in)
N2024-SW2	24 Vac	2	--		
N2024-P10K	24 Vac	--	10 kΩ		
N20230 / N20230-2POS	230 Vac	--	--	8 VA / 8 W	20 Nm (177 lb-in)
N20230-SW2	230 Vac	2	--		
N20230-P10K	230 Vac	--	10 kΩ		
N3424	24 Vac	--	--	9 VA / 9 W	34 Nm (300 lb-in)
N34230	230 Vac	--	--	13 VA / 10 W	34 Nm (300 lb-in)

Product Identification System

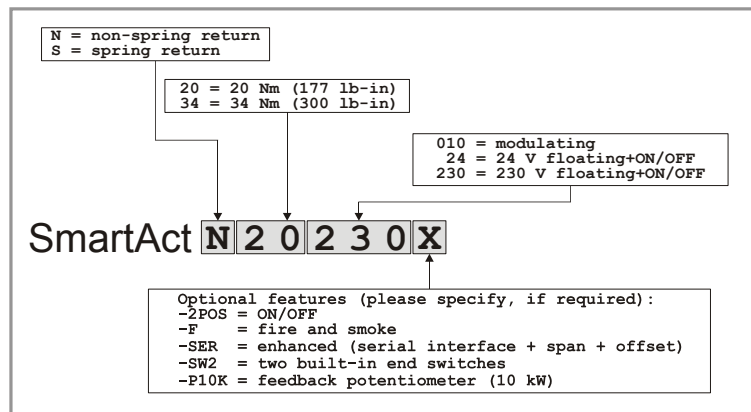
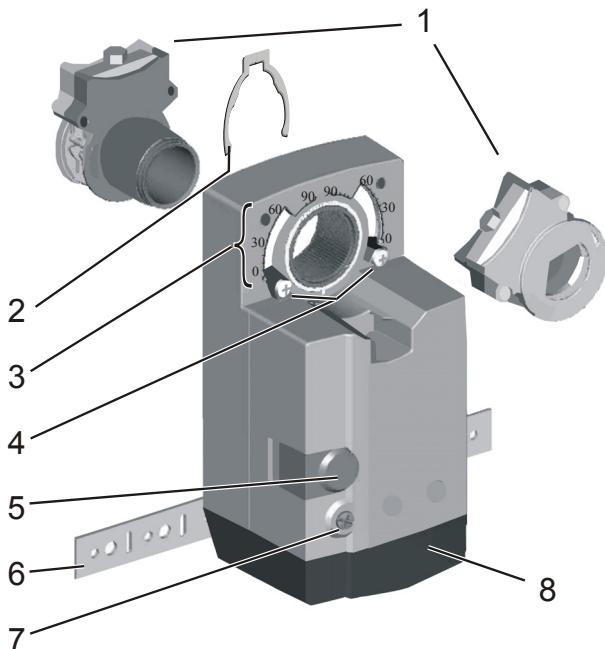

Fig. 1. Product Identification System

OPERATION / FUNCTIONS



Legend for Fig. 2:

- 1 Self-centering shaft adapter
- 2 Retainer clip
- 3 Rotational angle scales (0...90° / 90...0°)
- 4 Mechanical end limits (20 Nm [177 lb-in] models, only)
- 5 Declutch button
- 6 Anti-rotation bracket
- 7 Rotation direction switch
- 8 Access cover

Contents of Package

The delivery package includes the actuator itself, parts 1 through 8 (see Fig. 2), the anti-rotation bracket screws, and the SM mounting plate and screws.

Rotary Movement

The rotation direction (clockwise or counterclockwise) can be selected using the rotation direction switch (see part 7 in Fig. 2), thus eliminating the need to re-wire. To ensure tight closing of the dampers, the actuator has a total rotation stroke of 95°.

As soon as operating power is applied, the actuator may start to run. When power is removed, the actuator remains in position. For actuator-controller wiring instructions, see section "Wiring" on page 4.

Fig. 2. Setting units and control elements

Rotation Direction Switch

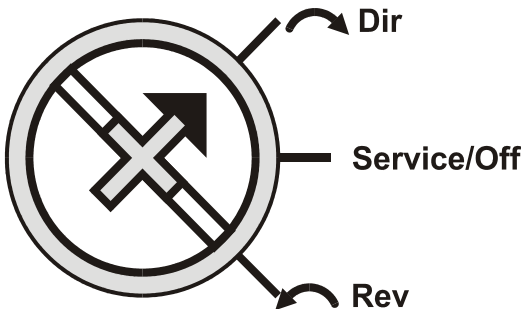

Fig. 3. Rotation Direction Switch

- **Dir** ("↻"): is the default shipping position. When the rotation direction switch is set to this position, the actuator internally switches the rotation direction control signals as stated in section "Wiring Diagrams" on pages 5 and 6.
- **"Service/Off"**: When the rotation direction switch is set to this position, all actuator rotary movement is cancelled and all control signals are ignored, thus enabling the actuator to be manually operated (see section "Manual Adjustment"). The user can then perform maintenance / commissioning without having to remove power from the actuator. To return to the control mode, simply move the rotation direction switch to its former setting.
- **Rev** ("↺"): When the rotation direction switch is set to this position, the actuator follows signals as stated in section "Wiring Diagrams" on pages 5 and 6.

Two-Position or Floating Control

The actuator is capable of being operated by either a two-position (open/close) or (unless explicitly identified as a 2-POS model) a floating (three-wire) controller. Refer to wiring diagrams for correct connection.

Feedback Signal

Actuators equipped with a feedback potentiometer provide position feedback via the potentiometer resistance value (see Fig. 4).

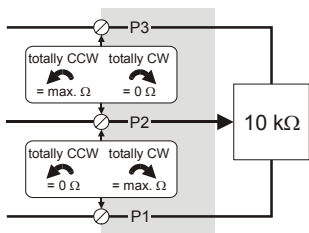

Fig. 4. Feedback signal settings

If, while the actuator is not rotating, the user declutches it and manually repositions the shaft adapter, the feedback signal will then follow the new position at which the shaft adapter has been left.

Position Indication

The hub adapter indicates the rotation angle position by means of the rotational angle scales (0...90° / 90...0°) provided in the actuator plate (see Fig. 5).

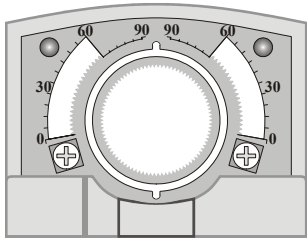

Fig. 5. Position indication

Manual Adjustment

IMPORTANT

To prevent equipment damage, you must remove power or set the rotation direction switch to the "Service/Off" position before manual adjustment.

After removing power or setting the rotation direction switch to the "Service/Off" position, the gear train can be disengaged using the declutch button, permitting the actuator shaft to be manually rotated to any position. The feedback signal will then follow the new position.

Limitation of Rotation Stroke

Two adjustable mechanical end limits (20 Nm [177 lb-in] models, only) are provided to limit the angle of rotation as desired (see Fig. 6).

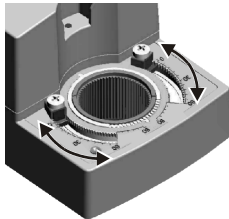

Fig. 6. Mechanical end limits

The mechanical end limits must be securely fastened in place as shown in Fig. 7. Specifically, it is important that they properly mesh with the rotational angle scales when the screws are tightened.

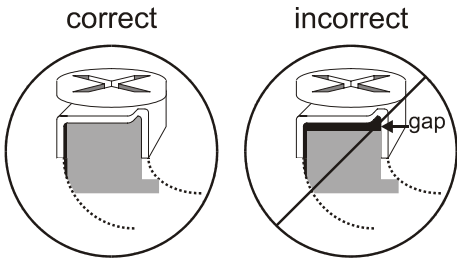

Fig. 7. Correct / incorrect tightening of end limits

Internal End Switches

NOTE: Only those actuators for which "-SW2" has been specified when ordering (e.g.: "N2024-SW2") feature internal end switches.

The internal end switches are set to switch from "common" to "normally open" at angles of 5° and 85°, respectively, from the totally counterclockwise position.

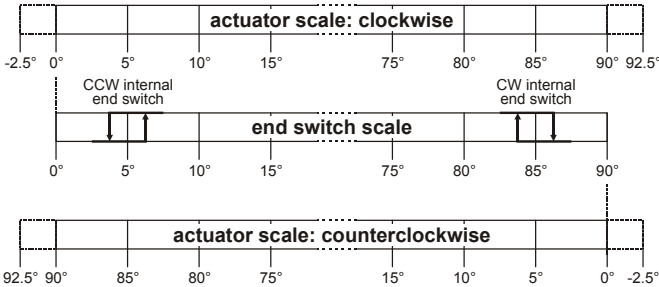

Fig. 8. Internal end switch triggering points

INSTALLATION

These actuators are designed for single-point mounting.

IMPORTANT

In order to prevent equipment damage, you must remove power or set the rotation direction switch to the "Service/Off" position before manual operation.

Mounting Instructions

All information and steps are included in the Installation Instructions supplied with the actuator.

Mounting Position

The actuators can be mounted in any position (no IP54 if mounted upside down; see Fig. 9). Choose a mounting position permitting easy access to the actuator's cables and controls.

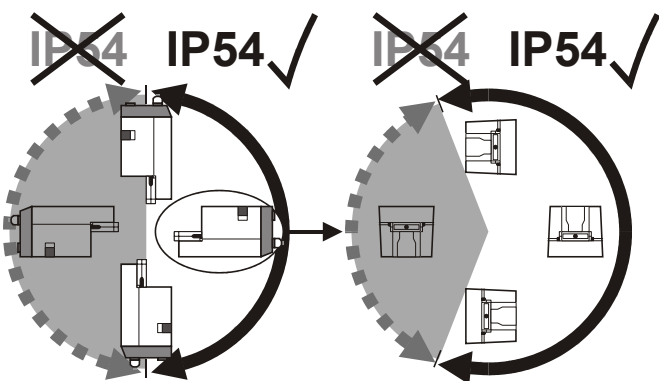

Fig. 9. Mounting for IP54

Mounting Bracket and Screws

If the actuator is to be mounted directly on a damper shaft, use the mounting bracket and screws included in the delivery package.

Self-Centering Shaft Adapter

The self-centering shaft adapter can be used for shafts having various diameters (10...27 mm [3/8...1-1/16"]) and shapes (square or round).

In the case of short shafts, the shaft adapter may be reversed and mounted on the duct side.

Stroke Limitation with Mechanical End Limits

The mechanical end limits (20 Nm [177 lb-in] models, only) enable the stroke to be limited from 0...90° in increments of 3°.

Wiring

Connecting to the Power Supply

In order to comply with protection class II, the power source of 24 V actuators must be reliably separated from the network power supply circuits as per DIN VDE 0106, part 101.

Access Cover

To facilitate wiring the actuator to the controller, the access cover can be detached from the actuator.

IMPORTANT

Remove power before detaching the access cover. Once the access cover has been removed, please take care to avoid damaging any of the parts now accessible.

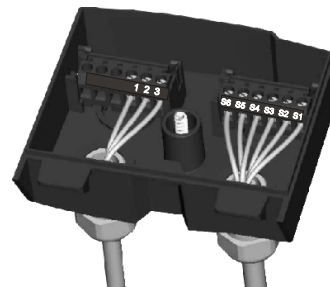

Fig. 10. Access cover (N2024-SW2)

Depending upon the model, the access cover may have one or two terminal strips, including a layout with a description for each of the terminals.

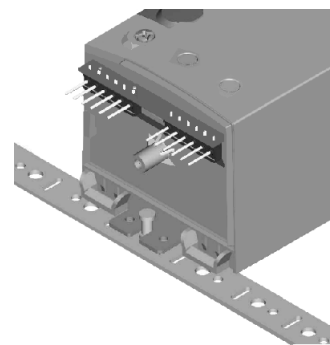
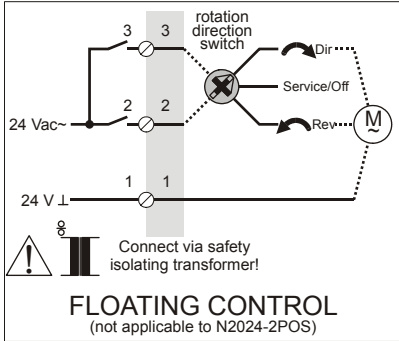
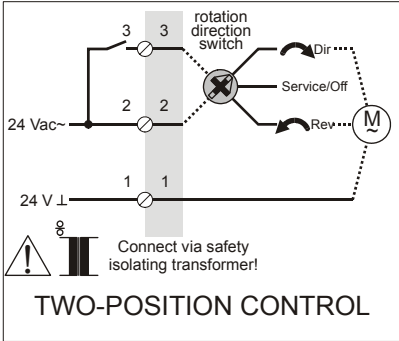
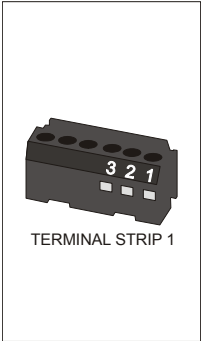

Fig. 11. N2024-SW2 with access cover removed

Wiring Diagrams

N2024 / N2024-2POS / N3424



N2024-SW2

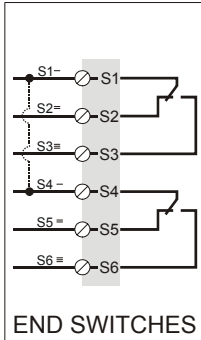
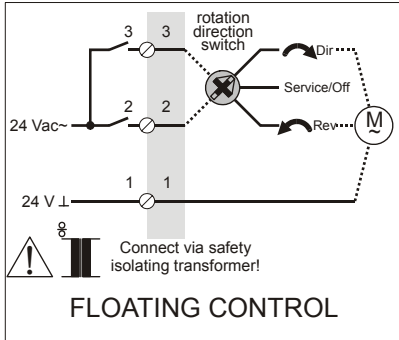
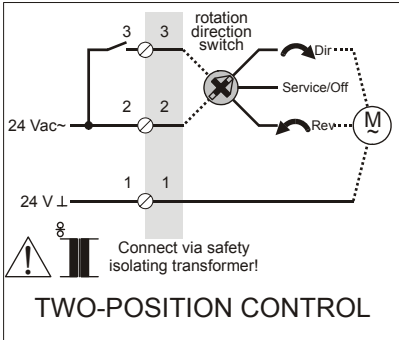
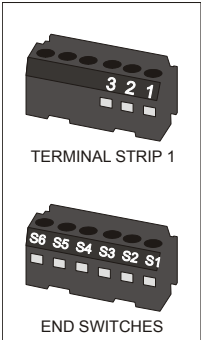

NOTE: Internal end switches S1 and S4 must be connected to the same power source.

N2024-P10K

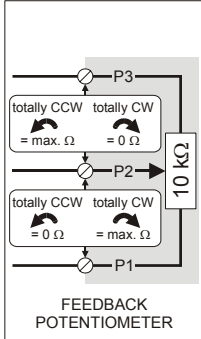
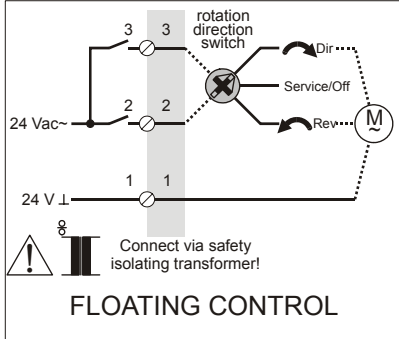
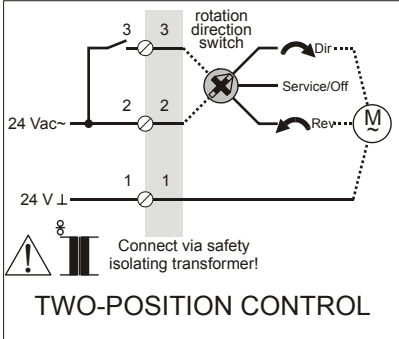
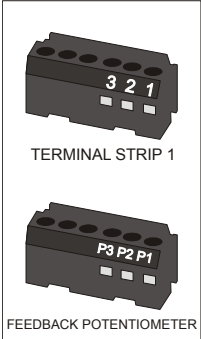

connecting cable	terminal	name	
		floating	two-position
supply and signal lines (must be equipped with spark suppressors)	1	24 Vac ⊥	24 Vac ⊥
	2	24 Vac (clockwise)	24 Vac ~
	3	24 Vac (counterclockwise)	24 Vac control signal
end switches (when included)	S1	common	
	S2	normally closed	
	S3	normally open	
	S4	common	
	S5	normally closed	
	S6	normally open	
feedback potentiometer	P1	full clockwise	
	P2	signal	
	P3	full counterclockwise	

N20230 / N20230-2POS / N34230

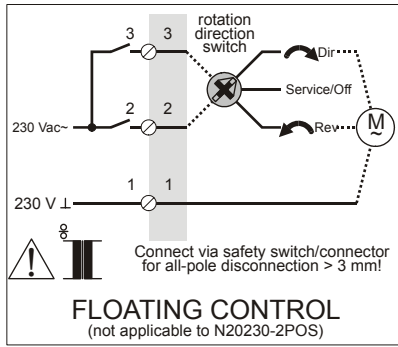
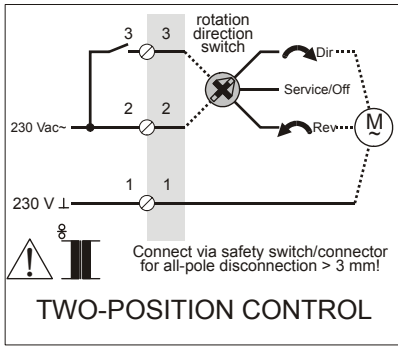
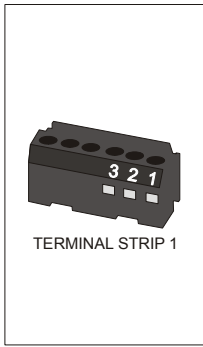

N20230-SW2

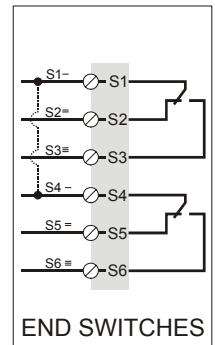
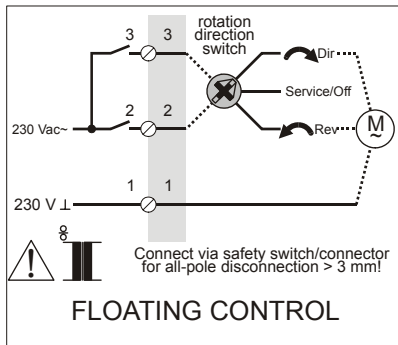
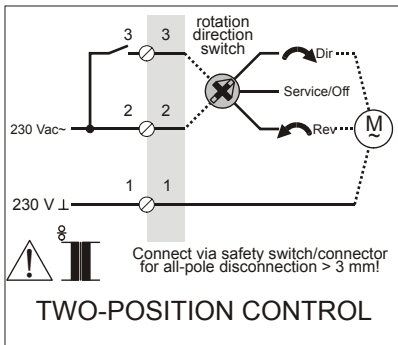
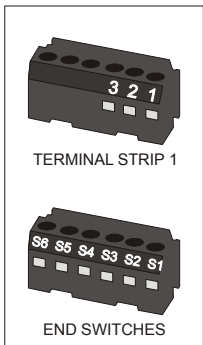

NOTE: Internal end switches S1 and S4 must be connected to the same power source.

N20230-P10K

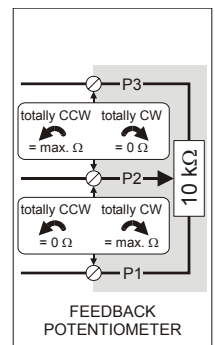
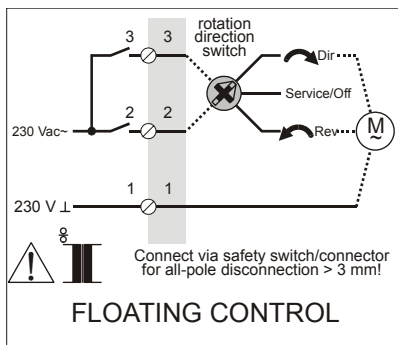
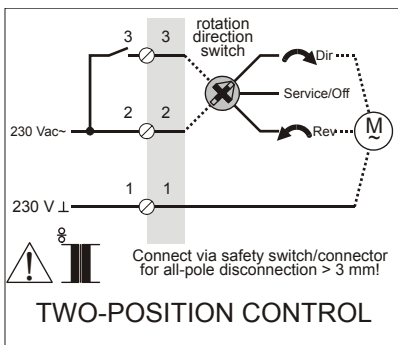
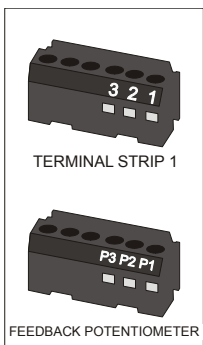

connecting cable		terminal	name	
			floating	two-position
supply and signal lines (must be equipped with spark suppressors)		1	230 Vac \perp	230 Vac \perp
		2	230 Vac (clockwise)	230 Vac ~
		3	230 Vac (counterclockwise)	230 Vac control signal
end switches (when included)	CCW (left) 5°	S1	common	
		S2	normally closed	
		S3	normally open	
	CW (right) 85°	S4	common	
		S5	normally closed	
		S6	normally open	
feedback potentiometer		P1	full clockwise	
		P2	signal	
		P3	full counterclockwise	

OPTIONAL ACCESSORIES

The following optional accessories can be ordered separately.

Auxiliary Switch Kit

Order no.: SW2

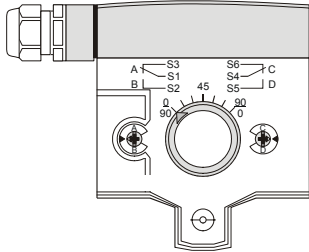

The internal auxiliary switches are field-installable parts providing two SPDT freely-adjustable switches.

Access Cover Kit

Order no.: WB20
For M20 outlets.

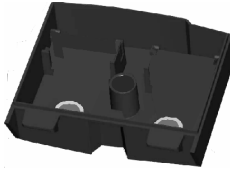

Contains:

- 1 access cover (with screw)
- 2 cable connectors
- 2 dust-protection caps

SPARE PARTS

Spare Parts Kit

Order no.: A7209.2071

The spare parts kit contains the following items:

- Anti-rotation bracket and screws
- SM Mounting plate and screws
- Access cover screw
- Plastic protective cap for protection standard IP54
- Mechanical end limit screw and retainer

Anti-Rotation Bracket Kit

Order no.: A7209.2073

The anti-rotation bracket kit can be ordered separately.

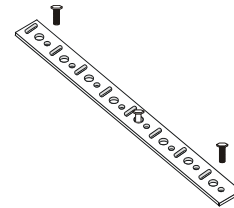

Contains:

- 10 anti-rotation brackets
- 20 screws

SM Mounting Plate Kit

Order no.: A7209.2072

The SM mounting plate kit can be ordered separately.

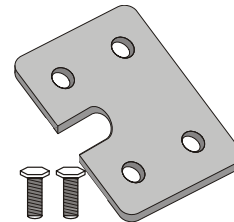

Contains:

- 10 SM mounting plates
- 20 screws

DIMENSIONS

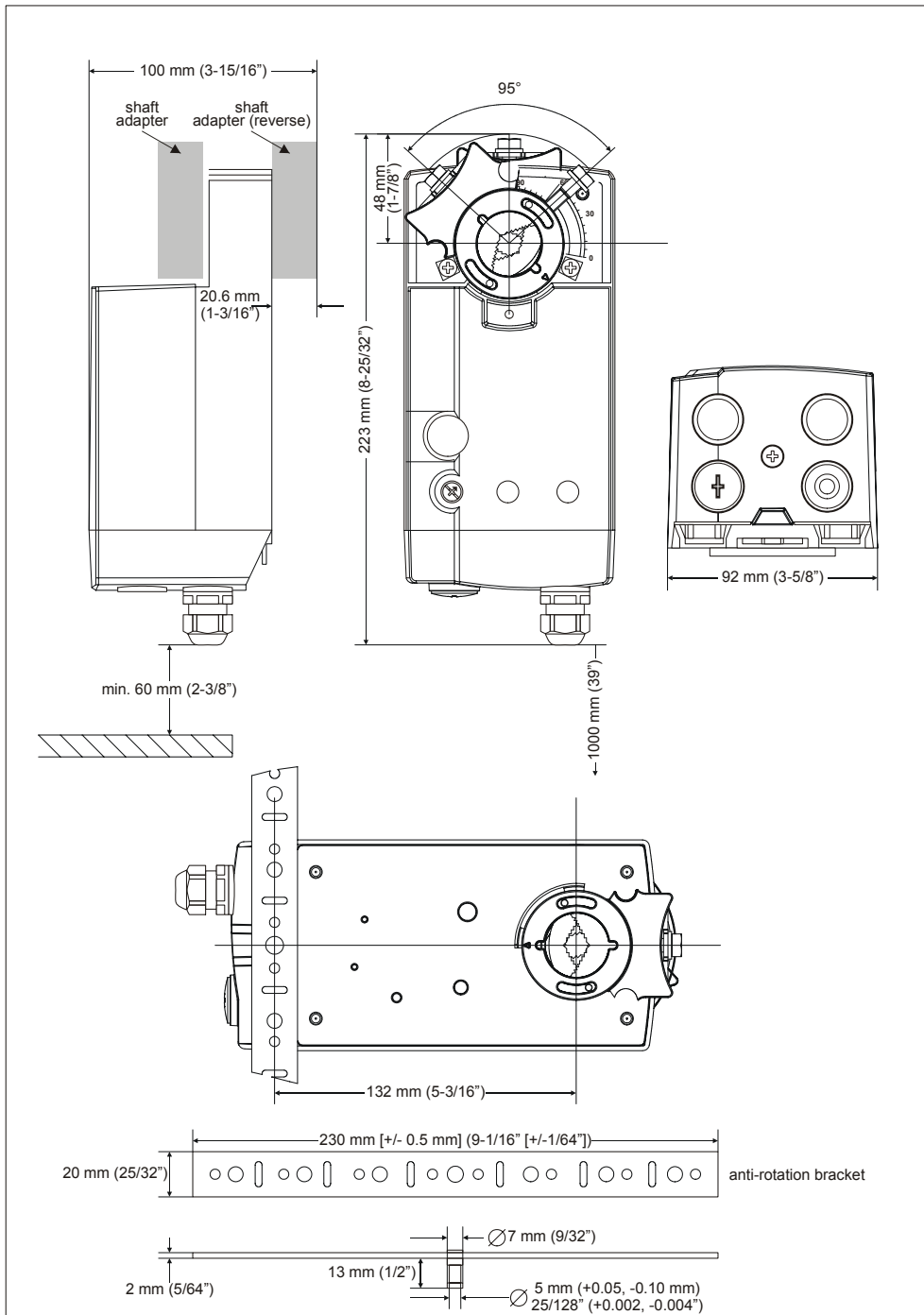

Honeywell

Manufactured for and on behalf of the Environmental and Combustion Controls Division of Honeywell Technologies Sàrl, Ecublens, Route du Bois 37, Switzerland by its Authorized Representative:

Automation and Control Solutions

Honeywell GmbH
 Böblinger Straße 17
 D-71101 Schönaich
 Phone: (49) 7031 63701
 Fax: (49) 7031 637493
<http://europe.hbc.honeywell.com>

Subject to change without notice. Printed in Germany
 EN0B-0320GE51 R0507

Manufacturing location certified to **DIN EN ISO 9001**