

Excel Smart I/O

XFC2A, XFC3A, XFC2D,
AND XFC3D MODULES

PRODUCT DATA

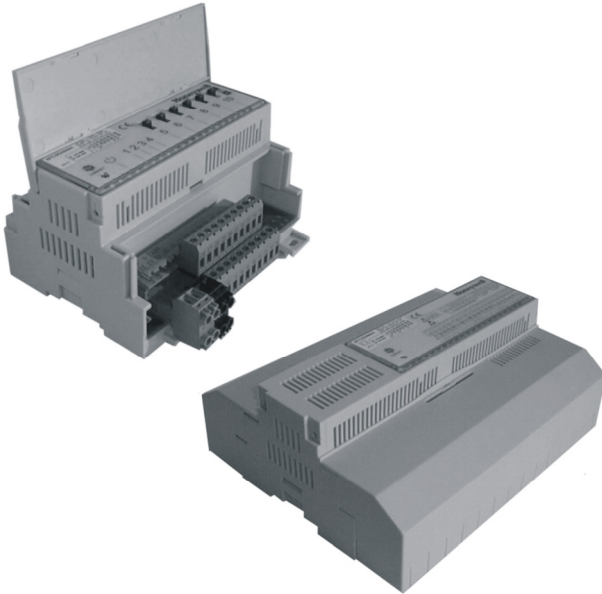

FEATURES

- LONMARK™ association-compliant, thus suitable for all open LONWORKS® networks
- Flexible, software-configurable inputs/outputs
- Flash memory for downloading applications (thus increasing flexibility and facilitating future upgrading)
- 2-wire FTT-10A LONWORKS® bus interface
- Easily-accessible service button and a service LED
- Four fast digital inputs configurable for static input or totalizing (at up to 20 Hz)
- Four relays to which (after software-configuration), e.g., floating actuators can be directly connected
- Four universal inputs, each with extra terminal for powering 24 Vac sensors, supporting NTC20k sensors, also configurable for voltage-variable or slow digital input
- Two analog outputs, each with extra terminal for powering 24 Vac actuators, supporting voltage-variable output
- Greater reliability, fewer cables (thus reducing fire burden), lower installation costs, easy start-up and servicing, digital communication
- DIN rail (wiring cabinet / fuse box) mounting and wall-mounting supported
- Fixed or removable terminals (model-dependent)
- 24 Vac or 230 Vac power supply (model-dependent)
- Optional six three-position, software-configurable manual overrides and corresponding feedback
- Optional terminal protection covers for wall mounting
- Optional swivel label holders for wiring information

GENERAL

Excel Smart I/O modules are LONMARK association-compliant devices, and can thus be used in all open LONWORKS environments. They feature a variety of software-configurable digital and analog inputs and outputs and are suitable for installation at strategic locations throughout your buildings. The modules convert physical input signals from sensors into network variables and the network variables into physical output signals for operating actuators.

The diverse mix of inputs and outputs (flexibly configurable using Honeywell's LonMaker for Windows™ plug-in) makes the Excel Smart I/O ideally suited for a wide range of intelligent, distributed applications.

Table 1 provides a brief overview of the available versions. See Table 4 on page 6 for details.

Table 1. Brief overview of Excel Smart I/O versions

Version	Description					
	power supply	overrides	UIs	DIs	AOs	relays
XFC2A06001	230 Vac	no	4	4	2	4
XFC3A06001	24 Vac	no	4	4	2	4
XFC2D06001	230 Vac	yes	4	4	2	4
XFC3D06001	24 Vac	yes	4	4	2	4

See also Table 4 for a more-detailed overview.

DESCRIPTION

With the Excel Smart I/O, you can choose from among four variants featuring universal inputs, digital inputs, analog outputs, and relays for use in conjunction with a wide range of sensor types and actuators. All module inputs and outputs are protected against overvoltages of max. 40 Vdc and 24 Vac. An extra power output terminal accompanying each analog input/output can also be used to power 24 Vac field devices.

Further, the individual inputs and outputs can be flexibly configured using the Honeywell plug-in. Thus, each of the four fast digital inputs can be configured for static input from dry contacts or open collectors or for totalizing signals having a frequency of up to 20 Hz, while the universal inputs can be configured for analog signals from NTC20k sensors, or for voltage-variable input, or for slow digital input (max. frequency = 0.25 Hz).

The XFC2D and XFC3D are equipped with six 3-position manual override switches. Using the Honeywell plug-in, these switches can be configured to override the individual relays or analog outputs. These modules also feature ten status LEDs showing the condition of the inputs / outputs allocated to them.

The XFC2A and XFC2D (long housing) are equipped with a transformer enabling them to be powered with 230 Vac (+10%/-15%). Their standby power consumption (= all outputs inactive, all inputs open, and all LEDs – except the power LED – OFF) is less than 10 VA. The XFC3A and XFC3D (short housings) require 24 Vac (±20%); their standby power consumption is less than 5 VA.

All modules are equipped with a power LED as well as with a LONWORKS service button and corresponding service LED.

Matching terminal protection covers and swivel label holders are available for all modules.

INTEROPERABILITY

The Excel Smart I/O is compliant with LONMARK Application Layer Guidelines V3.2. and thus interoperable with all other devices in open LONWORKS networks (including third-party devices). See also section "LonWorks Network Interface."

Excel Smart I/O Module Response Times

The *response time* is defined as the interval between the updating of the physical signal and the updating of the corresponding NV (or vice versa). Response times vary somewhat due to various factors. Assuming that only a single digital input changes at any given time, the corresponding response times will typically amount to approx. 1 sec. Thus, depending upon your specific circumstances, the Excel Smart I/O may be suitable for rapid-response applications.

LONMARK Objects

The Excel Smart I/O features a total of 15 LONMARK objects:

- one LONMARK node object (Obj#0) to allow monitoring and setting the status of the various sensor / actuator objects,
- four LONMARK open-loop sensor objects (Obj#1-4) (one for each universal input),
- four LONMARK open-loop sensor objects (Obj#5-8) (one for each digital input),
- two LONMARK open-loop actuator objects (Obj#9-10) (one for each analog output), and
- four LONMARK open-loop actuator objects (Obj#11-14) (one for each relay).

LONMARK Node Object

The LONMARK node object allows the various different objects in a node to be monitored. Upon receiving an update to `nviRequest`, `nvoStatus` is updated. The definition of `SNVT_obj_request` includes an object ID field to allow the node object to report status conditions for all objects in a node. The node self-documentation string lists the names of the individual LONMARK objects, allowing a network management node or tool to display useful information about an Excel Smart I/O; it also states (in the optional part after the semicolon) that the node is an Excel Smart I/O, and lists its version number.

Example:

```
network input sd_string("@x|y") SNVT_XXX
nvName;
```

where `input` can be replaced by `output`, `x` refers to the object `x` listed within `set_node_sd_string`, and `y` is the NV object within the following LONMARK object definition:

```
set_node_sd_string
"&"&3.2@0,1[4AI,1[4DI,3[2AO,3[4DO;SmartIO_01"
```

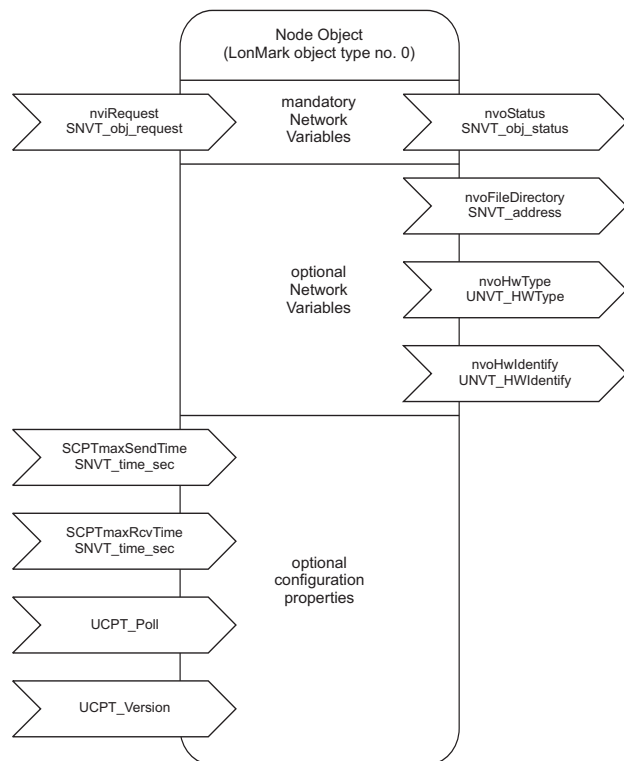

Fig. 1. Profile of LONMARK Node Object

Table 2. Node Object network variables

NV Name	Type	Description
nviRequest	SNVT_obj_request	RQ_NORMAL returns the object to the enabled, non-overridden state.
		RQ_DISABLED disables the object.
		RQ_ENABLE enables the object.
		RQ_UPDATE_STATUS posts the current settings of the flags of the specified object.
		RQ_REPORT_MASK reports the supported flags of the specified object.
		RQ_RESET resets the appropriate LonMark object: If the digital input object is configured for totalizing, it resets the totalizer to 65535 (0xFFFF); if associated to the node object, it resets the node.
		RQ_CLEAR_RESET requests that reset_complete be cleared.
		All other requests read to an "invalid_request" error.
nvoStatus	SNVT_obj_status	object_id is the ID of the object within the node.
		For invalid_id, a value of "1" means that the requested object ID is not implemented in this node.
		For invalid_request, a value of "1" means that unimplemented function has been requested.
		For disabled, a value of "1" means that the object has been disabled: those I/O objects not supported by the current hardware type will always be disabled.
		For open_circuit, a value of "1" means that an open circuit has been detected.
		For unable_to_measure, a value of "1" means that an I/O line has failed.
		For comm_failure, a value of "1" means that network communications have failed: one or more bound input NVs specified for receive heartbeat weren't updated within the configured receive heartbeat time.
		For manual_control, a value of "1" means that the actuator is under local control: this field applies to the output objects and the node object, only, and notifies whether the appropriate output was manually overridden.
		Not supported.
		For in_override, a value of "1" means that the module has been overridden via nviAoManOvrd or nviDoManOvrd.
		For report_mask, a value of "1" means that the status is an event mask.
		Not supported.
nvoFileDirectory	SNVT_address	Valid range: Any value within user data memory of Neuron Chip. Points to a file directory in the address space of the Neuron Chip. Used to access the configuration properties accessed by network management read/write messages.
nvoHwType	UNVT_HWType	Set at factory; stored in coprocessor's EEPROM. Represents the hardware type with respect to its OS number (e.g., XFC3A06001) and the coprocessor's software version. The hardware type is passed through the LONWORKS network as a polled output NV. Typically polled for diagnostic purposes.
nvoHWIdentify	UNVT_HWIdentify	Set at factory; stored in coprocessor's EEPROM. Used to identify the hardware by the number and types of I/Os supported by the actual hardware type. This information is passed through the LONWORKS network as a polled output NV. Typically polled for diagnostic purposes.
SCPTmaxSendTime	SNVT_time_sec	Valid range: 10...6553 s; in increments of 1 s (default = 60.0 s). Defines the maximum period of time before output NVs are automatically updated. Defines the Maximum Send Time and is accessible using standard LonMark mechanisms.
SCPTmaxRcvTime	SNVT_time_sec	Valid range: 0...6553 s (default = 0). Defines the max. time that elapses after the last update to a bound input NV. Defines the Maximum Received Time and is accessible using standard LonMark mechanisms. Setting to zero disables the receive failure detect mechanism.
UCPT_Poll		Valid range: Pre-set at factory. Configures the start-up behavior for input NVs with respect to getting an immediate update through a poll request. If enabled, any input NV bound to another node will initiate a poll request after reset, thus helping to avoid start-up problems until the next NV update. Polling based on a time grid of 1 sec, only. If disabled, the input NVs remain invalid until the next update is sent.
UCPT_Version		Valid range: Pre-set by application program. Identifies the current application and its version. Passed through the LONWORKS network as a read-only file. Readable using standard LonMark mechanisms.

LONMARK Sensor/Actuator Objects

All actuator objects have an output NV showing the actual state of the physical output and whether it is in the automatic or manual override mode. All sensor objects have a common configuration property defining the heartbeat time.

LONMARK Open-Loop Sensor Objects for Universal Inputs

The Excel Smart I/O makes use of four LONMARK open-loop sensor objects (one for each universal input) suitable for use in applications in which the actuator provides no feedback.

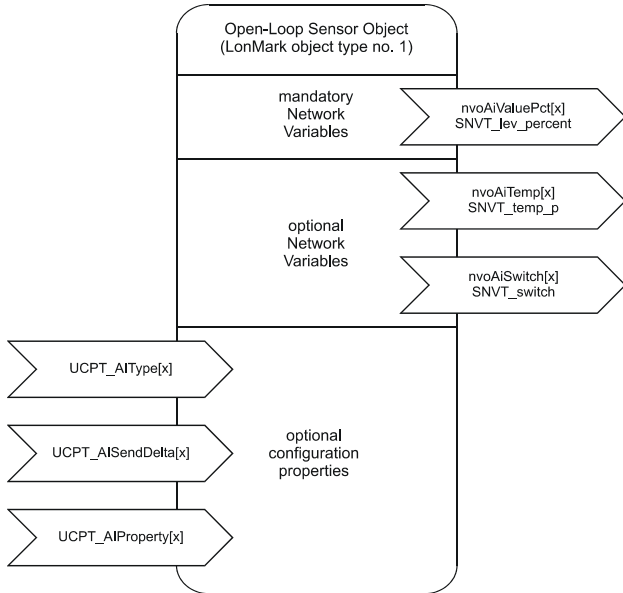

Fig. 2. Profile of LONMARK sensor object for UIs

LONMARK Open-Loop Sensor Objects for Digital Inputs

The Excel Smart I/O makes use of four LONMARK open-loop sensor objects (one for each digital input).

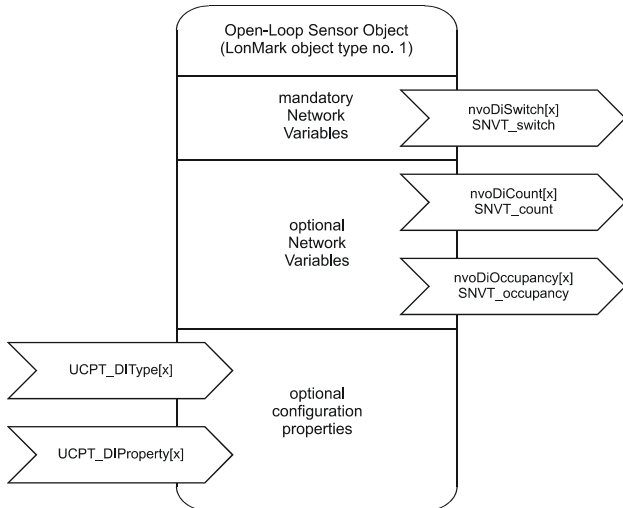

Fig. 3. Profile of LONMARK sensor objects for DIs

LONMARK Open-Loop Actuator Objects for Analog Outputs

The Excel Smart I/O makes use of two LONMARK open-loop actuator objects (one for each analog output).

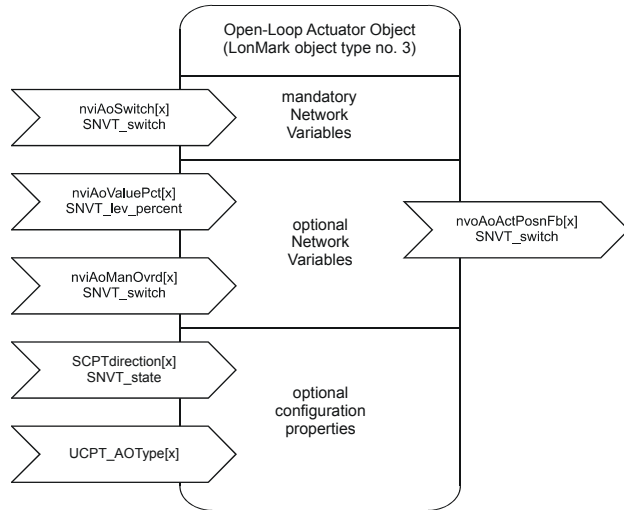

Fig. 4. Profile of LONMARK actuator objects for AOs

LONMARK Open-Loop Actuator Objects for Relays

The Excel Smart I/O makes use of four LONMARK open-loop actuator objects (one for each relay) individually configurable as simple ON/OFF controls or as floating outputs (in order to drive two physical outputs with configurable runtimes).

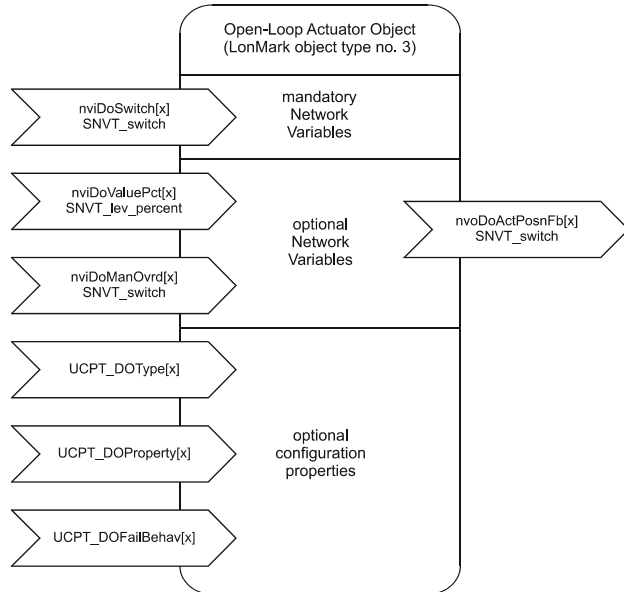

Fig. 5. Profile of LONMARK actuator objects for relays

Table 3. LONMARK sensor/actuator object NVs

NV Name	Type	Description
nvoAiValuePct	SNVT_lev_percent	Transmitted immediately when its value has changed by a rate higher than the configured "Send on Delta". Regularly transmitted as a heartbeat output.
nvoAiTemp	SNVT_temp_p	Transmitted immediately when its value has changed by a rate higher than the configured "Send on Delta". Regularly transmitted as a heartbeat output.
nvoAiSwitch	SNVT_switch	Transmitted immediately when its value has changed. Regularly transmitted as a heartbeat output.
UCPT_AIType	not applicable	Used to define the appropriate input type. Stored in the configuration parameter file accessible using standard LonMark mechanisms. Used by the NEC coprocessor.
UPCT_AISendDelta	not applicable	Defines the significant change rate of the associated input which should cause an immediate NV update to be sent. Stored in the configuration parameter file accessible using standard LONMARK mechanisms. Applies to the universal input type when configured for "Voltage" or "Temperature Sensor", respectively, and will be ignored for other input types.
UCPT_AIProperty	not applicable	Used to define some properties associated to the analog input. Stored in the configuration parameter file accessible using standard LONMARK mechanisms. Used by the NEC coprocessor.
nvoDISwitch	SNVT_switch	Represents a slow digital input connected to the digital input terminals. According to its configuration with respect to a normally open / normally closed contact, the output NV shows "state=0 / value=0%" for the "disabled" logical state, and "state=1 / value=100%" for the "enabled" logical state. Regularly transmitted as a heartbeat output as dictated by nciSndHrtBt.
nvoDICount	SNVT_count	Transmitted immediately when its value has changed more counts than defined in "Send on Delta". Regularly transmitted as a heartbeat output. After power-up and reset, the value 0xFFFF=65535 will be sent to the network to indicate to the receiving device that previous count values have been lost due to a reset.
nvoDiOccupancy	SNVT_occupancy	Transmitted immediately when the digital input state has changed. Regularly transmitted as a heartbeat output as dictated by nciSndHrtBt.
UCPT_DIType	not applicable	Used to set up the type of DI. It is stored in the configuration parameter file accessible using standard LONMARK mechanisms.
UCPT_DIProperty	not applicable	Used to define the properties associated with a digital input.
nvoAoActPosnFb	SNVT_switch	Represents the current status of the analog output, including feedback related to manual override initiated from either nviAoManOvr or the manual override switches. Typically used for monitoring purposes at supervisory stations or for diagnostic purposes. In the case of an override, the state is equal to -1.
nviAoSwitch	SNVT_switch	Used to drive the analog output to 0...100%. Typically bound to a LONWORKS control device issuing an output level 0...100%. A value of 110% is also possible (corresponding to a voltage range of 0...11 V).
nviAoValuePct	SNVT_lev_percent	Used to drive the AO to 0...100%. Typically bound to a LONWORKS control device issuing an output level 0...100%. A value of 110% is also possible (corresponding to a voltage range of 0...11 V).
nviAoManOvr	SNVT_switch	Used to manually override the analog output to 0...100%. Has priority over nviAoSwitch and nviAoValuePct. Typically used during start-up and commissioning; need not be bound. If relay is at present manually overridden, this will be reflected in nvoAoActPosnFb, accordingly. The manual override remains in force until explicitly reset to normal operation via power-up and reset. This state is therefore stored in EEPROM. If there has been a manual override to the same output, this will have priority over nviAoManOvr.
SCPTdirection	SNVT_state	Used to set the actuator sense of rotation and the safety position in case of any failure. Stored in the configuration parameter file accessible using standard LONMARK mechanisms.
UCPT_AOType	not applicable	Used to set up the various properties associated with an analog output point. Stored in the configuration parameter file accessible using standard LONMARK mechanisms.
nvoDoActPosnFb	SNVT_switch	Represents the current status of relay, including feedback related to manual override initiated from either nviDoManOvr or the manual override switches. Typically used for monitoring purposes at a supervisory station or for diagnostic purposes. In the case of floating actuator, nvoDoActPosnFb will monitor the actual valve position based on the calculation of the position within the motor model. In the case of an override, the state is equal to -1.
nviDoSwitch	SNVT_switch	Used to drive relay, which can be configured for different models, such as simple ON/OFF output, or floating output. Typically bound to a LONWORKS control device issuing an output level ON/OFF or 0...100%, as the case may be.
nviDoValuePct	SNVT_lev_percent	Used to drive relay to 0...100% when configured for floating type. Typically bound to a LONWORKS control device issuing an output level 0...100%. If both nviDoSwitch and nviDoValuePct receive valid values, nviDoValuePct will have priority.
nviDoManOvr	SNVT_switch	Used to manually override relay to ON/OFF. Has priority over nviDoSwitch and nviDoValuePct. Typically used during start-up and commissioning; need not be bound. If relay is at present manually overridden, this will be reflected in nvoDoActPosnFb, accordingly. The manual override remains in force until explicitly reset to normal operation via power-up and reset. This state is therefore stored in EEPROM. If there has been a manual override to the same output, this will have priority over nviDoManOvr.

UCPT_DOType	not applicable	Used to set up the type of relay point. Stored in the configuration parameter file accessible using standard LONMARK mechanisms. Used by the NEC coprocessor.
UCPT_DOPProperty	not applicable	Used to set up the various properties of a relay. Depending upon the selected output type, various different properties can be set up which are stored in the configuration parameter file accessible using standard LONMARK mechanisms. Used by the NEC coprocessor.
UCPT_StatusLED	not applicable	Used to set up the various properties associated with a status LEDs. Stored in the configuration parameter file accessible using standard LONMARK mechanisms. Used by the NEC coprocessor.
UCPT_ManOvrdSw	not applicable	Used to set up the manual override switches accordingly. Stored in the configuration parameter file accessible using standard LONMARK mechanisms. Used by the NEC coprocessor.

Table 4. Detailed overview of Excel Smart I/O versions

	XFC2A06001	XFC3A06001	XFC2D06001	XFC3D06001
housing	long	short	long	short
power supply	230 Vac	24 Vac	230 Vac	24 Vac
terminals	FIXED	FIXED	REMOVABLE	REMOVABLE
manual overrides	--	--	six	six
status LEDs	--	--	ten	ten
UIs	NTC20k	four	four	four
fast DI	four	four	four	four
AOs	0...10 V	two	two	two
N.O. / C.O. relays	2 / 2	2 / 2	2 / 2	2 / 2
nominal power consumption	20 VA	10 VA	20 VA	10 VA
estimated heat dissipation (cos Φ = 0.5)	10 W	5 W	10 W	5 W
standby power consumption	< 10 VA	< 5 VA	< 10 VA	< 5 VA

TECHNICAL DATA

General

The Excel Smart I/O is equipped with a 10-MHz 3150 Neuron® Chip (which executes the application program and implements the LonTalk protocol) and a NEC coprocessor (for handling the inputs and outputs). It communicates within the LONWORKS network at a rate of 78 kilobaud via an FTT-10A Free Topology Twisted Pair Transceiver

Each module is equipped with four 230 Vac, 6 A digital outputs, i.e. relays (including two normally open [N.O.] and two changeover [C.O.] relays). Floating actuators can be directly connected to these relays once they have been configured using the Honeywell plug-in.

Further, each Excel Smart I/O is equipped with four fast digital inputs. Each fast digital input can be reconfigured (using the Honeywell plug-in) to accept static input (from dry contacts or open collectors) or to totalize input signals (having a frequency of up to 20 Hz).

Each module is also equipped with four universal inputs and two analog outputs (see section "Universal Inputs and Analog Outputs" below), each of which has an extra power output terminal for supplying 24 Vac power to field devices.

The XFC2D and XFC3D also feature six 3-position manual override switches and ten status LEDs (see section "Manual Overrides and Status LEDs" below).

Optional accessories include swivel label holders and terminal protection covers (see "Optional Accessories" below).

A power LED, a LONWORKS service LED, and a corresponding LONWORKS service button (see sections "LONWORKS Service LED" and "LONWORKS Service Button" below) are located on the top of each module.

There are two standard module sizes: long modules (with a built-in 230 Vac transformer) and short modules (requiring

24 Vac power supply). See section "Long and Short Housings" below.

Universal Inputs and Analog Outputs

The modules are equipped with four universal inputs and two analog outputs.

Universal Inputs

The term "universal inputs" refers to analog inputs for NTC20k signals which can also be reconfigured as voltage-variable or slow digital inputs. Using the Honeywell plug-in, the NTC20k input can be configured to

- 0(2)...10 Vdc signals or
- Dry-contact / open-collector signals (max. frequency = 0.25 Hz).

The universal inputs have an individually configurable offset.

The universal inputs have a 10-bit resolution, with a typical accuracy of ± 0.1 V and an impedance of > 100 kOhm to GND for voltage input.

Each universal input features an extra power output terminal for supplying 24 Vac voltage to active sensors.

Analog Outputs

Each module is equipped with two analog outputs providing 0...11 VDC signals. Each analog output features an extra power output terminal for supplying 24 Vac voltage to actuators.

The analog outputs have a permissible load of > 10 kOhm, and a typical accuracy of ± 0.2 V.

Other Module-Specific Features / Options

Manual Overrides and Status LEDs

The XFC2D and XFC3D are each equipped with six 3-position (ON, OFF, AUTO) manual override sliding switches with which the individual digital/analog output signals can be overridden. The manual override switches can be configured using the Honeywell plug-in.

These same modules are each equipped with a total of ten colored status LEDs:

- The four 3-color software-configurable LEDs can be used to test whether signals from, e.g., digital inputs are changing. They can also indicate whether the hardware is defective.
- The four yellow software-configurable LEDs are ordinarily used for relays.
- The two red variable-intensity LEDs are connected to the analog outputs; their brightness varies according to the strength of the corresponding signal (i.e. 0 = dark LED, 10 V = bright LED)

See also the section of the plug-in's on-line help on status LED configuration.

Long and Short Housings

The XFC2A and XFC2D are equipped with a transformer enabling them to be powered with 230 Vac, and they thus feature long housings (W x L x H = 180 x 76 x 110 mm).

The XFC3A and XFC3D require a 24 Vac power supply and feature short housings (W x L x H = 126 x 76 x 110 mm).

Optional Accessories

Optional accessories include matching terminal protection covers (available in packs of 8) and swivel label holders (available in packs of 8).

Those Excel Smart I/O modules featuring override switches require swivel label holders onto which the labels containing customer-specific wiring information can be applied. The swivel label holders are snapped into place on the housing.

LONWORKS Network Interface

The Excel Smart I/O communicates within the LONWORKS network at a rate of 78 kilobaud via an FTT-10A Free Topology Twisted Pair Transceiver. This transceiver provides transformer isolation so that the bus wiring does not have a polarity.

Devices equipped with this transceiver can be wired in daisy chain, star, loop, or any combination thereof as long as the max. wire length requirements are met. The recommended configuration is a daisy chain with two termination modules. This layout allows for maximum bus length, and its simple structure presents the least number of possible problems, particularly when adding on to an existing bus. For more information, please refer to <http://www.echelon.com>

Configuration and Binding

The network variables of the Excel Smart I/O are configured and bound using the Honeywell plug-in.

LONWORKS Service Button

All models feature a LONWORKS service button accessible from the outside on the top of module for use in installation

and troubleshooting. When the service button is pressed, the following actions take place:

- The service pin message is issued on the network.
- When the service button has been pressed longer than 30 sec, the node reverts to normal mode.

The service pin message is broadcast:

- whenever the service button has been pressed;
- after each reset due to power-up, software reset;
- when changing the mode from offline to online.

See also Excel Smart I/O Installation Instructions (EN1B-0180GE51) for more-detailed information.

LONWORKS Service LED

All models feature a LONWORKS service LED connected to the Neuron® Chip service LED output. The service LED displays numerous different behaviors indicating various module states for use in troubleshooting.

See also Excel Smart I/O Installation Instructions (EN1B-0180GE51) for a complete description of these behaviors.

For more information on standard service LED behavior, refer to Motorola LONWORKS Technology Device Data Manual, page AL-190.

Accessories, Standards, etc.

Accessories

- Swivel label holders; short and long variants (required for modules equipped with manual override switches).
24 Vac models, order number: XAL_LAB_S
230 Vac models, order number: XAL_LAB_L
- The XAL-Term 2 Termination Module (one or two required, depending on LONWORKS bus layout; see Excel 500 Installation Instructions, EN1R-1047GE51 for details).
- Terminal protection covers; short and long variants (required for wall/ceiling mounting).
24 Vac models, order number: XAL_COV_S
230 Vac models, order number: XAL_COV_L

Approvals and Standards

- CE and EN 50081-1
- LONMARK Application Layer Guidelines Version 3.2

Housings

- IP20 or IP30 (standard housing)

Environmental Ratings

- Operating temperature: 32...122 °F (0...50 °C)
- Shipping/storage temperature: -22...158 °F (-30...70 °C)
- Relative humidity (operation and storage): 5...90%, non-condensing

Applicable Literature

- Excel Smart I/O Installation Instructions (EN1B-0180GE51)
- Excel 50/500 LONWORKS Mechanisms (EN0B-0270GE51)
- Honeywell's Excel Smart plug-in help file

DIMENSIONS

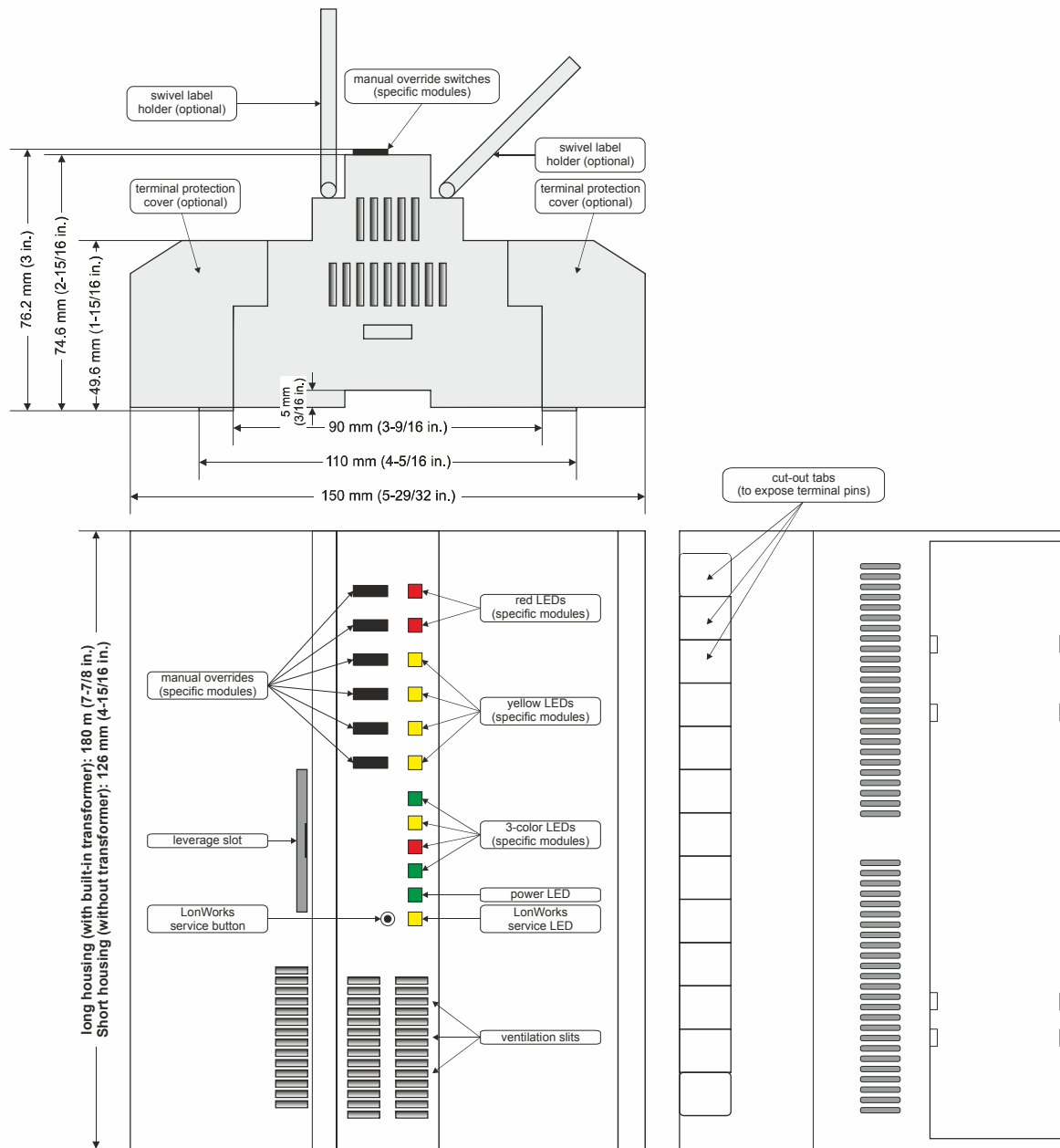

Fig. 6. Dimensions and main features

Honeywell

Manufactured for and on behalf of the Environmental and Combustion Controls Division of Honeywell Technologies Sàrl, Rolle, Z.A. La Pièce 16, Switzerland by its Authorized Representative:

Automation and Control Solutions

Honeywell GmbH
 Böblinger Strasse 17
 71101 Schönaich, Germany
 Phone +49 (0) 7031 637 01
 Fax +49 (0) 7031 637 740
<http://ecc.emea.honeywell.com>

EN0B-0311GE51 R0714

Subject to change without notice